

DR Series

1U Rack Mount Dual Slide LCD Keyboard DVI KVM

1U 19" Dual Slide LCD Keyboard / KVM Drawer, 104 key notepad keyboard w/ touch pad (e), with 12-port DVI-D only+ USB+ Audio KVM switch, Audio out x 1, Includes NC-6: 6pc 6ft long DVI +USB+ Audio KVM Cables, 650mm(26 inch) Deep

Model: DR119-12De



FEATURES:

- 1U dual slide 19" LCD console drawer
- 104-key keyboard with touchpad
- Enhanced aesthetics with new molded front panel and two point lock
- Short depth design of 650mm(26 inch)Deep
- 12-port DVI-D, USB & Audio KVM
- DVI-D single link support 1920 x 1200 transmission
- Support widescreen & native SUN 1152 x 900 resolution
- Multi-platform for PCs, SUN and Mac G3 / G4 Mac / iMac
- Hot pluggable, no software or drivers required

SPECIFICATIONS:

LCD Panel	
Diagonal size	19" TFT
Max. Resolution	1280 x 1024
Brightness (cd/m2)	250
Backlight	LED
Colors	16.7M
Contrast Ratio (typ)	1000 : 1
Viewing Angle (H/V)	170° x 160°
Active area (mm)	376 x 301
MTBF (hrs)	30,000
Casing Color	Black (RAL 9005)
Weight (Single console	
Net	13.2 kgs (29 lbs)
Gross	19 kgs (41.8 lbs)
Environmental	
Operating	0 to 50°C Degree
Storage	-5 to 60°C Degree
Relative humidity	5-90%, non-condensing
Shock	10G acceleration (11 ms duration)
Vibration	5-500Hz 1G RMS random vibration
Power	
Input	Auto-sensing 100 to 240VAC, 50 / 60Hz
Consumption	Max. 48 Watt, Standby 5 Watt
Product Dimensions (Single console)	
Product	441.6 x 650 x 44 mm / 17.4 x 25.6 x 1.73 inch
Packing	595 x 860 x 140 mm / 23.4 x 33.9 x 5.5 inch



STRUCTURE DIAGRAM

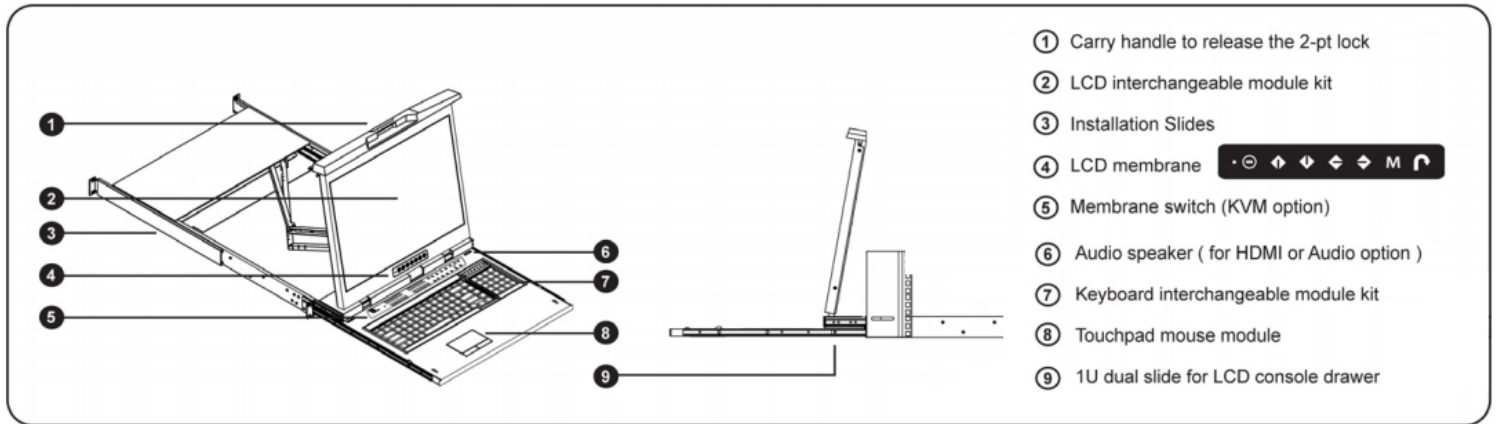





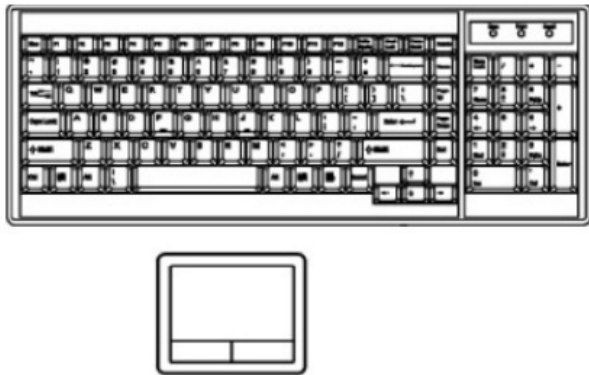









STANDARD KEYBOARD

e keyboard integrated with touchpad



Supporting layouts

America					
	United States				
EMEA					
	United Kingdom	Germany	France	Spain	Norway
					
	Italy	Russia	Switzerland	Netherlands	Portugal
	Asia				
	China	Japan	Korea	Arabia	Turkey

KVM PORT CONNECTION

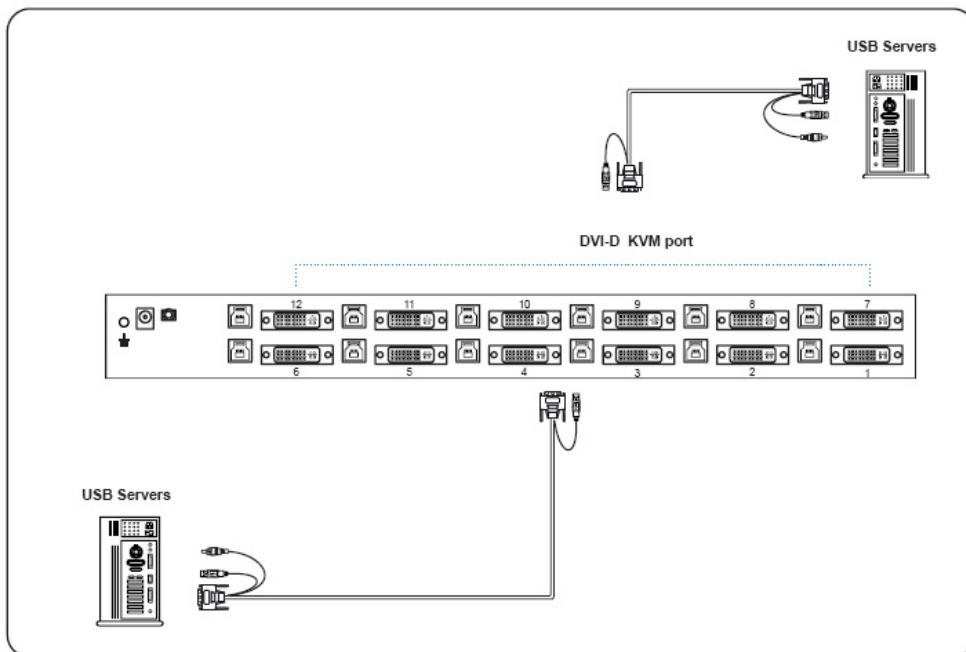

DVI KVM Cable

NC-6: 6 feet DVI KVM Cable

NC-15: 6 feet DVI KVM Cable

(Server end : DVI-D+USB+Audio)

(KVM Port: DVI-D+USB 3.0)



DVI KVM SPECIFICATIONS

KVM Port	
Number of ports:	12
Connector:	DVI-D connector
	USB 3.0 connector (combined for keyboard, mouse & audio)
Connectivity:	Combo 4-in-1 KVM cable, 6 or 15 feet
Local Console	
Graphic connector:	1 x DVI-D
Resolution:	Up to 1920x1200
Input device:	2 x USB type A for keyboard & mouse
Audio out:	1 x 3.5mm stereo audio
Management	
PC Selection:	Front button & keyboard hotkey
Compatibility	
Multi-platform:	Mix PCs, SUN and Mac G3 / G4 Mac / iMac
Support:	Windows 7 / Vista / 2003 / XP, Linux, Unix

Regulatory	
Safety:	FCC & CE certified
Environment:	RoHS2 & REACH compliant
Environmental	
Operating:	0 to 50°C
Storage:	-5 to 60°C
Relative humidity:	90%, non-condensing
Shock:	50G peak acceleration (11ms, half-sine wave)
Vibration:	58-100Hz/0.98G (11ms/ cycle)

Front Panel - Port LED Indications

DVI-D KVM 12 ports

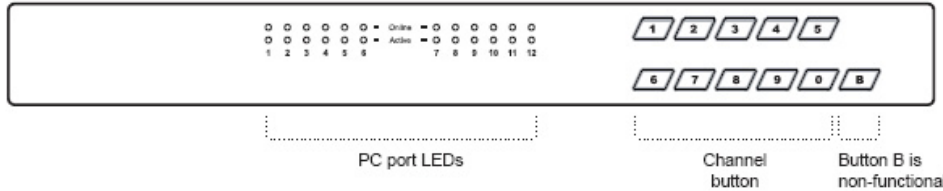

PC port LEDs	Online : Blue LED on indicating a PC is connecting to the port Active : Green LED on indicating a selected channel
Channel button	Press to select channel from 01 to 12