

HNVP Series

1U Rack Mount TFT High Brightness USB HUB KVM LCD Monitor Drawer

USB HUB KVM

NetView:1U Rackmount 1000nits High-Brightness 17" TFT 1280x1024 LCD KVM
Over IP remote 8-ports USB RGB KVM switch (Includes 8 pcs 6ft long NB-6
Cables) and 2 x USB 2.0 port sharing USB peripheral for computers, with 104
key notepad keyboard w/ Touchpad (e), 23 inch Deep

Model: HNVP117-IPB8e

FEATURES:

- 1000cd/m² for 17" LCD
- Front USB port for device access (USB Hub KVM only)
- Lower power consumption
- High shock & vibration resistance
- Short depth design of 580mm(23 inch) Deep
- New enhanced aesthetics with molded front handle
- Minimum EMI emissions

SPECIFICATIONS:

LCD Panel	
Diagonal size	17" TFT
Max. Resolution	1280 x 1024
Brightness (cd/m ²)	1000
Backlight	LED
Colors	16.7M
Contrast Ratio (typ)	1000 : 1
Viewing Angle (H/V)	170° x 160°
Active area (mm)	338 x 270
MTBF (hrs)	50,000
Casing Color	Black (RAL 9005)
Weight (Single console	
Net	12.5 kgs (27.5 lbs)
Gross	17.5 kgs (38.5 lbs)
Environmental	
Operating	0 to 50°C Degree
Storage	-5 to 60°C Degree
Relative humidity	5-90%, non-condensing
Shock	10G acceleration (11 ms duration)
Vibration	5-500Hz 1G RMS random vibration
Regulatory	FCC & CE certified
Environmental	RoHS2 & REACH compliant
Power	
Input	Auto-sensing 100 to 240VAC, 50 / 60Hz
Consumption	Max. 48 Watt, Standby 5 Watt
Product Dimensions (Single console)	
Product	441.6 x 580 x 44 mm / 17.4 x 23 x 1.73 inch
Packing	590 x 808 x 140 mm / 23.2 x 31.8 x 5.5 inch



STRUCTURE DIAGRAM



- ① LCD interchangeable module kit
- ② Installation Slides
- ③ LCD membrane 
- ④ Membrane switch (KVM option)
- ⑤ Micro switch for screen auto power off
- ⑥ Keyboard interchangeable module kit
- ⑦ Mouse interchangeable module kit
- ⑧ Blue Power LED
- ⑨ Front USB port for device access (USB Hub KVM only)
- ⑩ Molded front handle

STANDARD KEYBOARD

















e keyboard integrated with touchpad



b keyboard integrated with trackball



Supporting layouts

America	 United States				
EMEA	 United Kingdom	 Germany	 France	 Spain	 Norway
	 Italy	 Russia	 Switzerland	 Netherlands	 Portugal
Asia	 China	 Japan	 Korea	 Arabia	 Turkey

BUILT-IN USB HUB USAGE & CONNECTION

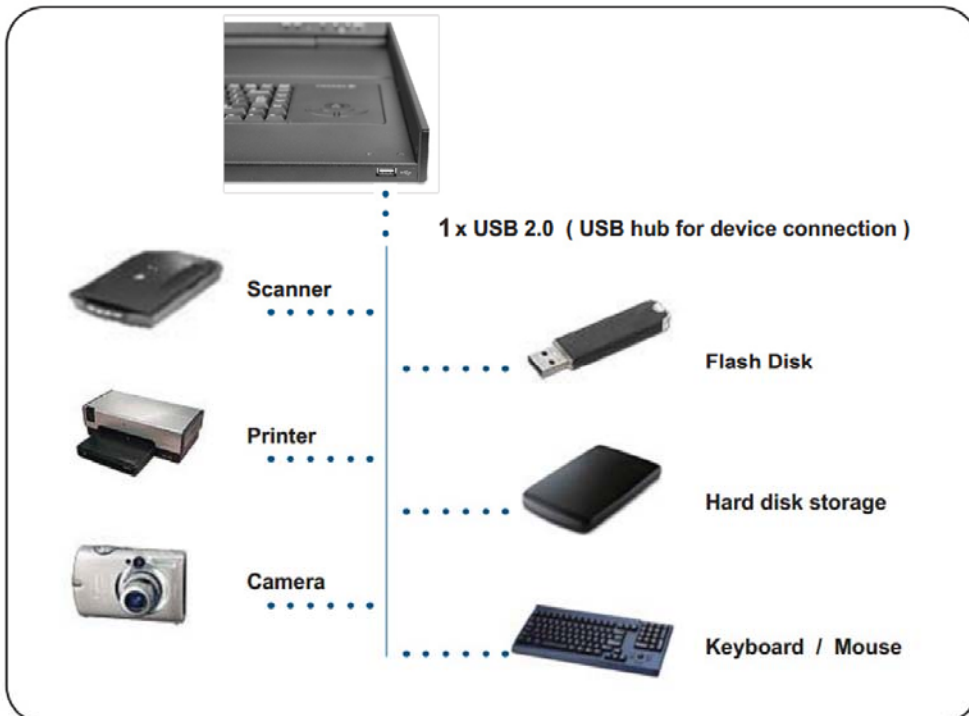

USB Hub DB-15 IP KVM Benefits

- VGA-USB DB-15 KVM with either 8 or 16 ports in 1U
- IP remote access across the world wide web
- 2 x USB 2.0 port sharing USB peripheral for computers
- Mix USB & SUN with Multi-Platform switch capability
- Support resolution up to 1920 x 1080
- SUN 1152 x 900 resolution compatible
- Hot pluggable, no software or drivers required
- Easy & quick installation

Switch Features & Options

- Multi lingual on screen display menu
- Control hardware and software systems from a remote location without physically being at the server's location
- Advanced user profiles and configurable OSD hot key combinations
- 12V, 24V and 48V DC Power options

Note: No Daisy chain function on USB Hub KVM model

8-ports

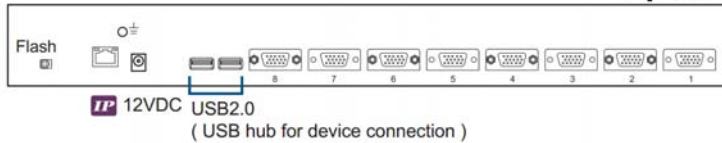

16-ports

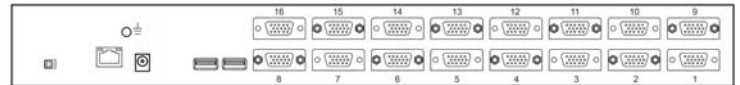

Real View



KVM SPECIFICATIONS

■ KVM Port	
Number of ports:	8 or 16
Connector:	DB-15 combo connector
Connectivity:	Combo 2-in-1 VGA + USB KVM cable, 6, 10 or 15 feet
■ Local Console	
Graphic connector:	1 x DB-15
Resolution:	Up to 1920x1200
Input device:	2 x USB type A for keyboard & mouse
USB hub:	2 x USB type A for sharing other peripheral devices among the computers
■ IP Remote Console	
Connector:	RJ45 Ethernet
User management:	15-user login, 1 x active user
Network protocol:	DHCP / BOOTP / DNS
Security:	SSL v3, RSA, AES, HTTP / HTTPS, CSR
Resolution:	Up to 1600 x 1200
Browser:	IE, Firefox, Safari, Netscape
■ Compatibility	
Multi-platform:	Mix PCs, SUN and Mac G3 / G4 Mac / iMac
Support:	Windows 7 / Vista / 2003 / XP, Linux, Unix

■ Power	
Input:	Auto sensing 100 to 240VAC, 50 / 60 Hz
Option DC:	12V / 24V / 48V DC input
Consumption:	Max. 12 Watt, Standby 5 Watt
■ Regulatory :	
Safety:	FCC & CE certified
Environment:	RoHS2 & REACH compliant
■ Environmental	
Operating:	0 to 50°C
Storage:	-5 to 60°C
Relative humidity:	90%, non-condensing
Shock:	50G peak acceleration (11ms, half-sine wave)
Vibration:	58-100Hz / 0.98G (11ms / cycle)
■ Product Information	
Dimension (W x D x H):	443 x 171 x 44 mm / 17.4 x 6.7 x 1.73 inch
Net weight:	3 kg / 6.5 lb
■ Packing Information	
Dimension (W x D x H):	500 x 400 x 90 mm / 19.7 x 15.7 x 3.5 inch
Gross weight:	5 kg / 11 lb

KVM PORT CONNECTION

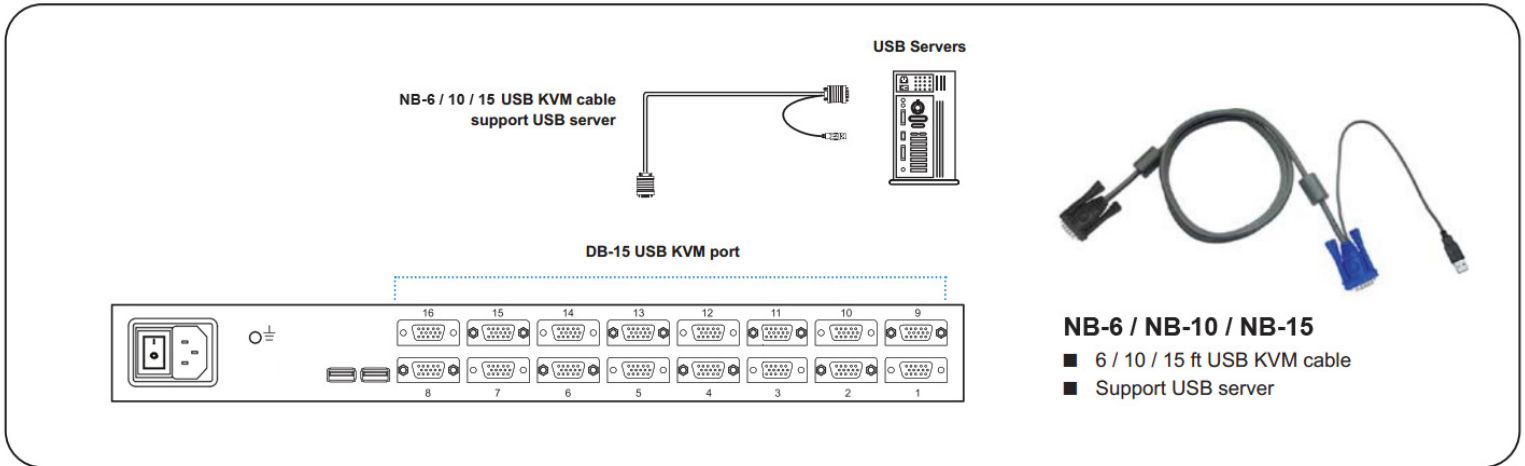

IP & Local console connection

