

HNVP Series

1U Rack Mount TFT High Brightness USB HUB KVM LCD Monitor Drawer

USB HUB KVM

NetView:1U Rackmount 1000nits High-Brightness 19" TFT 1280x1024 LCD KVM
8- ports USB RGB KVM switch (Includes 8 pcs 6ft long NB-6 Cables) and 2 x
USB 2.0 port sharing USB peripheral for computers, with 104 key notepad
keyboard w/ Touchpad (e), 25 inch Deep

Model: HNVP119-B8e

FEATURES:

- 1000cd/m² for 19" LCD
- Front USB port for device access (USB Hub KVM only)
- Lower power consumption
- High shock & vibration resistance
- Short depth design of 620mm(25 inch) Deep
- New enhanced aesthetics with molded front handle
- Minimum EMI emissions

SPECIFICATIONS:

| | |
|--|---|
| LCD Panel | |
| Diagonal size | 19" TFT |
| Max. Resolution | 1280 x 1024 |
| Brightness (cd/m ²) | 1000 |
| Backlight | LED |
| Colors | 16.7M |
| Contrast Ratio (typ) | 1000 : 1 |
| Viewing Angle (H/V) | 160° x 160° |
| Active area (mm) | 376 x 301 |
| MTBF (hrs) | 50,000 |
| Casing Color | Black (RAL 9005) |
| Weight (Single console | |
| Net | 13.2 kgs (29 lbs) |
| Gross | 18.2 kgs (40 lbs) |
| Environmental | |
| Operating | 0 to 50°C Degree |
| Storage | -5 to 60°C Degree |
| Relative humidity | 5-90%, non-condensing |
| Shock | 10G acceleration (11 ms duration) |
| Vibration | 5-500Hz 1G RMS random vibration |
| Regulatory | FCC & CE certified |
| Environmental | RoHS2 & REACH compliant |
| Power | |
| Input | Auto-sensing 100 to 240VAC, 50 / 60Hz |
| Consumption | Max. 48 Watt, Standby 5 Watt |
| Product Dimensions (Single console) | |
| Product | 441.6 x 620 x 44 mm / 17.4 x 25 x 1.73 inch |
| Packing | 590 x 808 x 140 mm / 23.2 x 31.8 x 5.5 inch |



STRUCTURE DIAGRAM

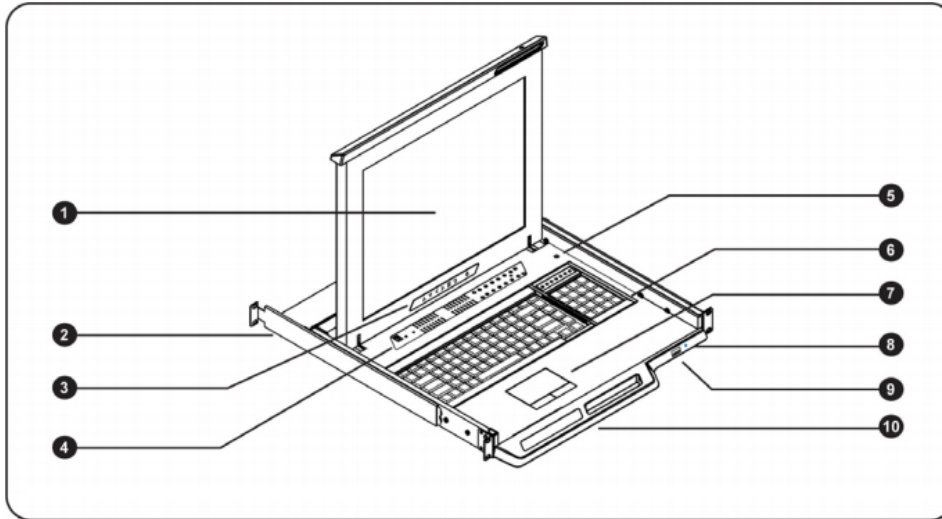

- ① LCD interchangeable module kit
- ② Installation Slides
- ③ LCD membrane 
- ④ Membrane switch (KVM option)
- ⑤ Micro switch for screen auto power off
- ⑥ Keyboard interchangeable module kit
- ⑦ Mouse interchangeable module kit
- ⑧ Blue Power LED
- ⑨ Front USB port for device access (USB Hub KVM only)
- ⑩ Molded front handle

STANDARD KEYBOARD

















e keyboard integrated with touchpad



b keyboard integrated with trackball



Supporting layouts

| | | | | | | |
|---------|--|--|---|---|--|--|
| America |  United States | | | | | |
| EMEA |  United Kingdom |  Germany |  France |  Spain |  Norway | |
| |  Italy |  Russia |  Switzerland |  Netherlands |  Portugal | |
| | America |  China |  Japan |  Korea |  Arabia |  Turkey |

BUILT-IN USB HUB USAGE & CONNECTION

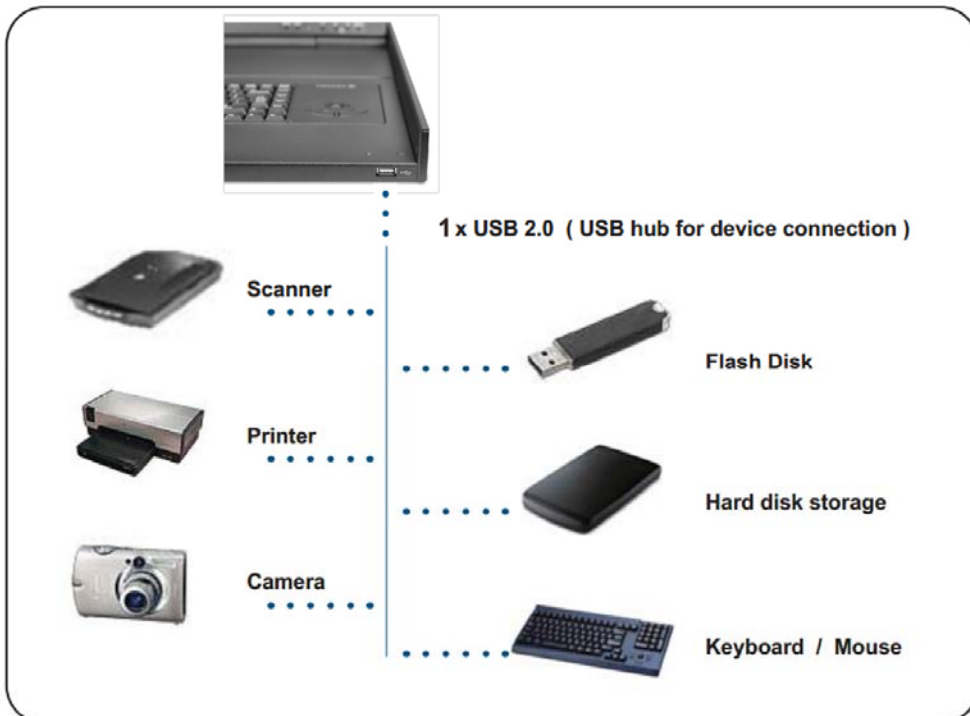

USB Hub DB-15 KVM Benefits

- VGA-USB DB-15 KVM with either 8 or 16 ports in 1U
- 2 x USB 2.0 port sharing USB peripheral for computers
- Mix USB & SUN with Multi-Platform switch capability
- Support resolution up to 1920 x 1080
- SUN 1152 x 900 resolution compatible
- Hot pluggable, no software or drivers required
- Easy & quick installation

Switch Features & Options

- Multi lingual on screen display menu
- Advanced user profiles and configurable OSD hot key combinations
- 12V, 24V and 48V DC Power options

Note: No Daisy chain function on USB Hub KVM model



Real View



KVM SPECIFICATIONS

| | |
|------------------------|--|
| ■ KVM Port | |
| Number of ports: | 8 or 16 |
| Connector: | DB-15 combo connector |
| Connectivity: | Combo 2-in-1 VGA + USB KVM cable, 6, 10 or 15 feet |
| ■ Local Console | |
| Graphic Connector: | 1 x DB-15 |
| Resolution: | Up to 1920 x 1200 |
| Input device: | 2 x USB type A for keyboard & mouse |
| USB hub: | 2 x USB type A for sharing other peripheral devices among the computers |
| ■ Management | |
| Multilingual OSD: | English, France, German, Spanish, Italian, Russian, Simplified Chinese, Japanese |
| Hotkey Combination: | Scroll-lock, Cap-lock, Num-lock, Alt, Ctrl & Win |
| Security: | Password enable & Disable, up to 8 users profile for port access |
| PC Selection: | Front button, OSD menu & Hotkey |
| ■ Compatibility | |
| Multi-platform: | Mix PCs, SUN and Mac G3 / G4 Mac / iMac |
| Support: | Windows 7 / Vista / 2003 / XP, Linux, Unix |

| | |
|------------------------------|--|
| ■ Power | |
| Input: | Auto sensing 100 to 240VAC, 50 / 60 Hz |
| Option DC: | 12V / 24V / 48V DC input |
| Consumption: | Max. 12 Watt, Standby 5 Watt |
| ■ Regulatory : | |
| Safety: | FCC & CE certified |
| Environment: | RoHS2 & REACH compliant |
| ■ Environmental | |
| Operating: | 0 to 50°C |
| Storage: | -5 to 60°C |
| Relative humidity: | 90%, non-condensing |
| Shock: | 50G peak acceleration (11ms, half-sine wave) |
| Vibration: | 58-100Hz / 0.98G (11ms / cycle) |
| ■ Product Information | |
| Dimension (W x D x H): | 443 x 171 x 44 mm / 17.4 x 6.7 x 1.73 inch |
| Net weight: | 3 kg / 6.5 lb |
| ■ Packing Information | |
| Dimension (W x D x H): | 500 x 400 x 90 mm / 19.7 x 15.7 x 3.5 inch |
| Gross weight: | 5 kg / 11 lb |

KVM PORT CONNECTION

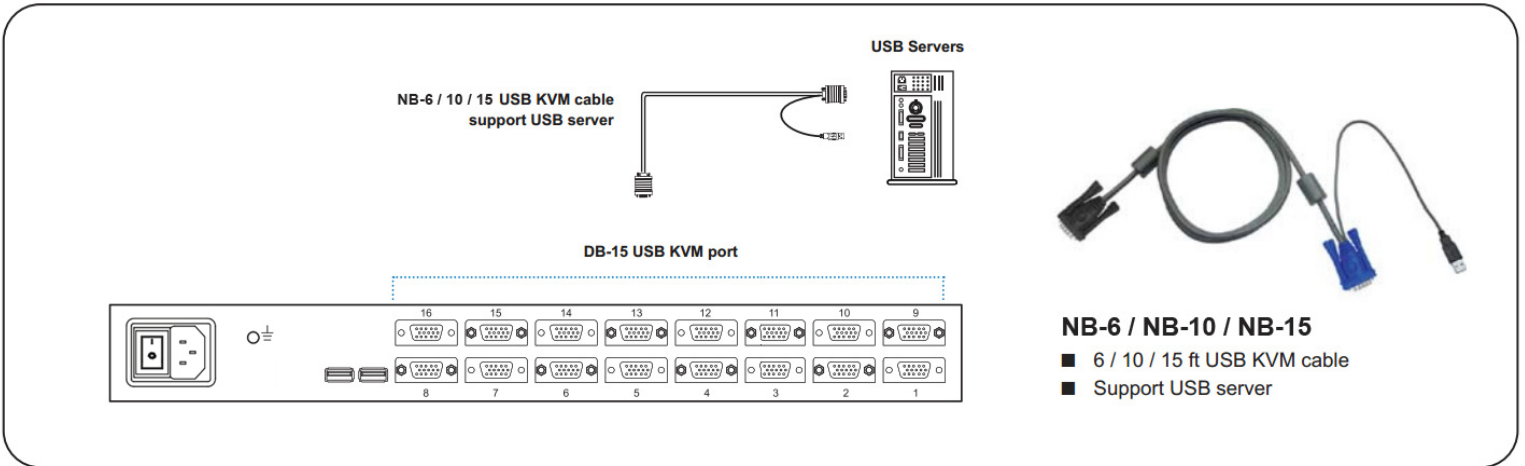

Front Panel - Port LED Indications

