

# HNW Series

1U Rack Mount TFT High Brightness LCD Monitor KVM Drawer

## USB HUB KVM

NetView: 1U Rackmount 1000nits High-Brightness 17" Widescreen 1920 x 1080 LCD KVM with 104 key notepad keyboard w/ Trackball ( b ), Integrated with DB-15, 16 KVM Ports + 0 User Via CAT5 Extender + 0 Users Via KVM over IP. Over Depth is 22.8 Inch. Dongles sold separately

Model: HNW17HD-B16b

### FEATURES:

- 1U 17" widescreen LCD console drawer with high brightness 1000 cd/m<sup>2</sup>
- Support Full HD with 1080p resolution
- Lower power consumption, high shock & vibration resistance
- Minimum EMI emissions
- 104-key keyboard with trackball
- New enhanced aesthetics with molded front handle
- Front USB port for device access (USB Hub KVM only)

### OPTIONAL FEATURES::

- 3G / HD / SD-SDI Broadcast-grade input (w/ speaker)
- DC power: 12V / 24V / 48V / 110 ~ 125V
- HDMI (w/ speaker)

### SPECIFICATIONS:

LCD Panel	
Diagonal size	17.3" widescreen TFT
Max. Resolution	1920 x 1080
Brightness (cd/m <sup>2</sup> )	1000
Backlight	LED
Colors	16.7M
Contrast Ratio (typ)	600 : 1
Viewing Angle (H/V)	160° x 140°
Active area (mm)	382 x 215
MTBF (hrs)	50,000
Casing Color	Black ( RAL 9005 )
Weight ( Single console	
Net	10.8 kgs / 24 lbs
Gross	15.8 kgs / 34.8 lbs
Environmental	
Operating	0 to 55°C Degree
Storage	-20 to 60°C Degree
Relative humidity	5~90%, non-condensing
Shock	10G acceleration ( 11 ms duration )
Vibration	5~500Hz 1G RMS random vibration
Regulatory	FCC & CE certified
Power	
Input	Auto-sensing 100 to 240VAC, 50 / 60Hz
Consumption	Max. 65 Watt, Standby 6 Watt
Product Dimensions ( Single console )	
Product	441.6 x 480 x 44 mm / 17.4 x 18.9 x 1.73 inch
Packing	590 x 808 x 140 mm / 23.2 x 31.8 x 5.5 inch





- Hold the handle and slide out the drawer.



- Flip up the LCD to a suitable angle



- Operate the LCD console drawer.

## DIMENSION

Front View

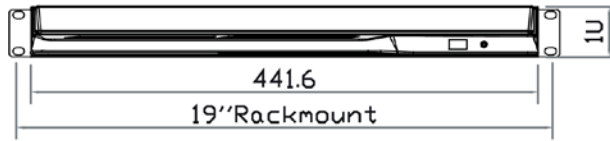

Rear View



Side View

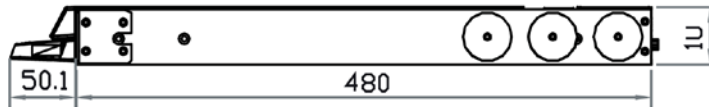

Top View

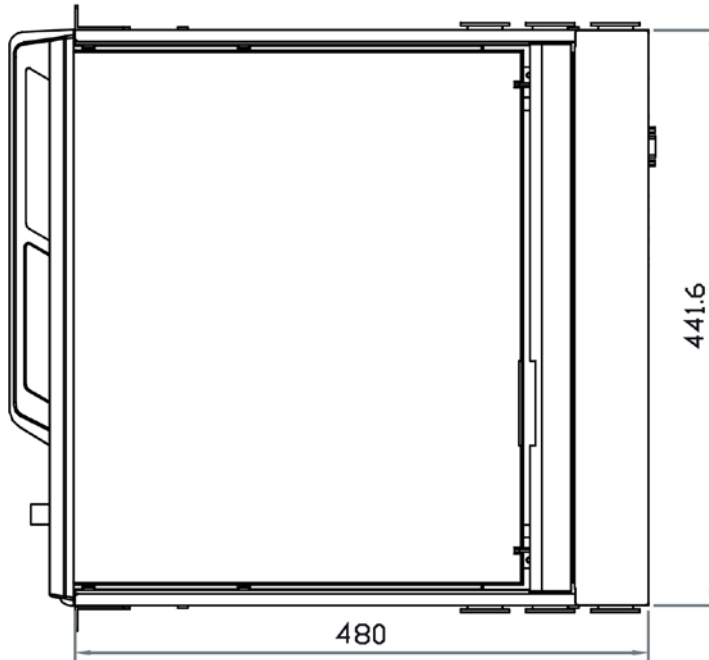

UNIT : mm  
1mm = 0.03937 inch

## STANDARD KEYBOARD



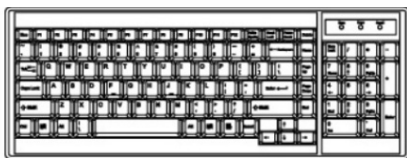













e keyboard integrated with touchpad



b keyboard integrated with trackball



### Supporting layouts

America	 United States				
EMEA	 United Kingdom	 Germany	 France	 Spain	 Norway
	 Italy	 Russia	 Switzerland	 Netherlands	 Portugal
Asia	 China	 Japan	 Korea	 Arabia	 Turkey

## STRUCTURE DIAGRAM

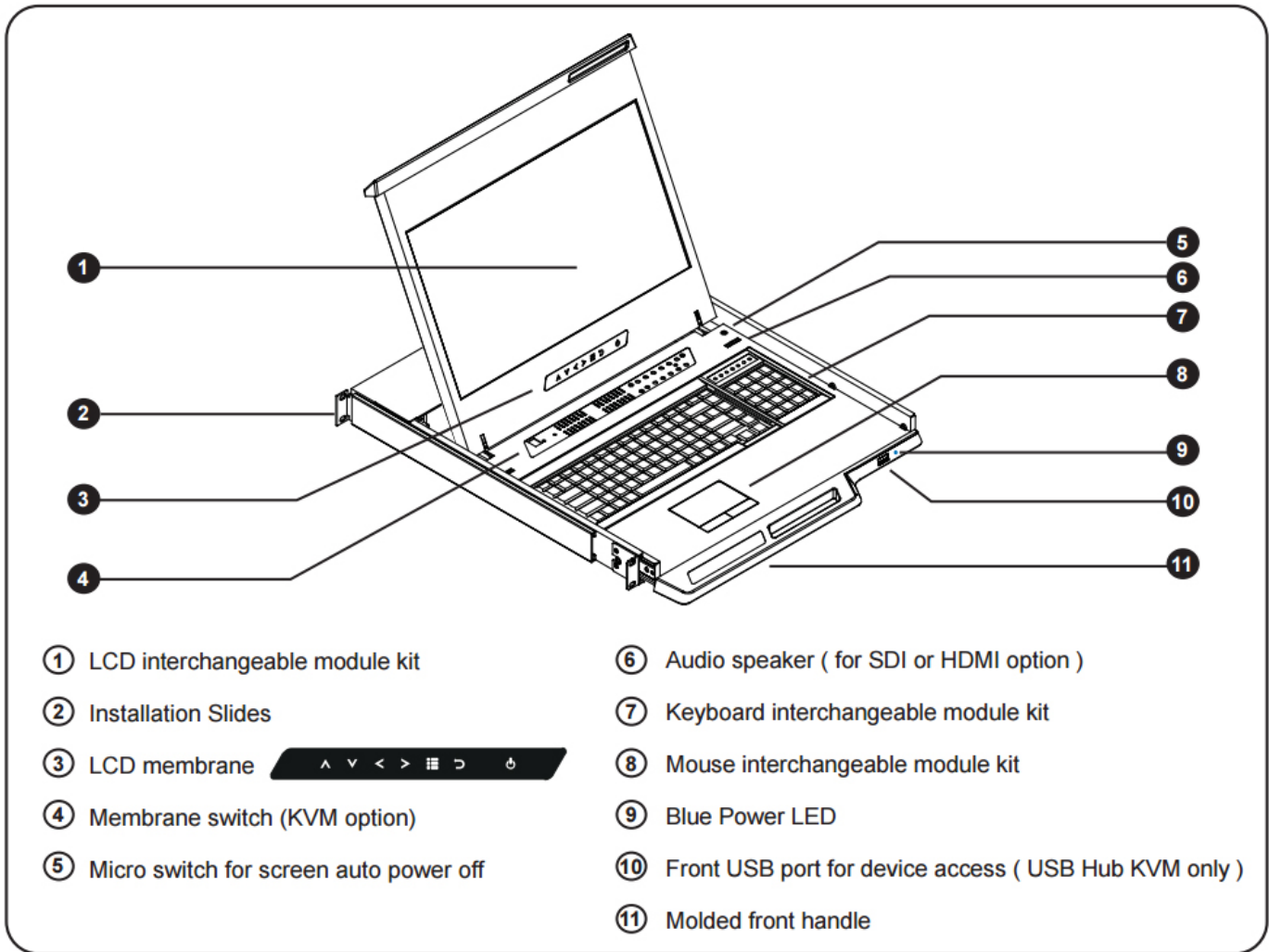

## BUILT-IN USB HUB USAGE & CONNECTION

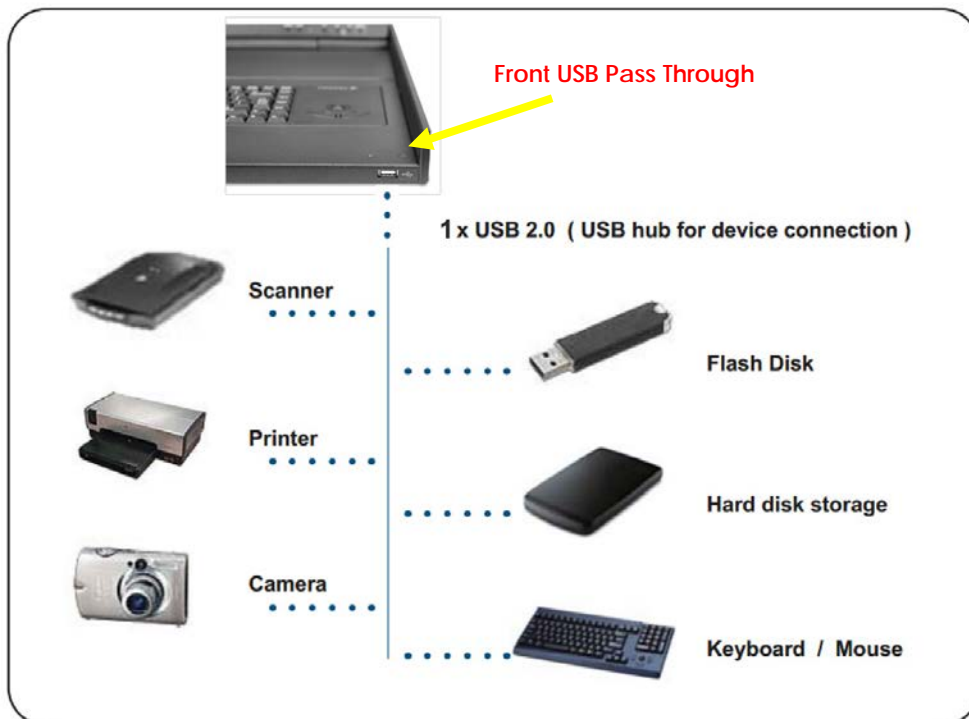

## USB Hub DB-15 IP KVM Benefits

- VGA-USB DB-15 KVM with either 8 or 16 ports in 1U
- IP remote access across the world wide web
- 2 x USB 2.0 port sharing USB peripheral for computers
- Mix USB & SUN with Multi-Platform switch capability
- Support resolution up to 1920 x 1080
- SUN 1152 x 900 resolution compatible
- Hot pluggable, no software or drivers required
- Easy & quick installation

## Switch Features & Options

- Multi lingual on screen display menu
- Control hardware and software systems from a remote location without physically being at the server's location
- Advanced user profiles and configurable OSD hot key combinations
- 12V, 24V and 48V DC Power options

**Note: No Daisy chain function on USB Hub KVM model**



## Real View



## KVM SPECIFICATIONS

<b>■ KVM Port</b>	
Number of ports:	8 or 16
Connector:	DB-15 combo connector
Connectivity:	Combo 2-in-1 VGA + USB KVM cable, 6, 10 or 15 feet
<b>■ Local Console</b>	
Graphic connector:	1 x DB-15
Resolution:	Up to 1920x1200
Input device:	2 x USB type A for keyboard & mouse
USB hub:	2 x USB type A for sharing other peripheral devices among the computers
<b>■ IP Remote Console</b>	
Connector:	RJ45 Ethernet
User management:	15-user login, 1 x active user
Network protocol:	DHCP / BOOTP / DNS
Security:	SSL v3, RSA, AES, HTTP / HTTPS, CSR
Resolution:	Up to 1600 x 1200
Browser:	IE, Firefox, Safari, Netscape
<b>■ Compatibility</b>	
Multi-platform:	Mix PCs, SUN and Mac G3 / G4 Mac / iMac
Support:	Windows 7 / Vista / 2003 / XP, Linux, Unix

<b>■ Power</b>	
Input:	Auto sensing 100 to 240VAC, 50 / 60 Hz
Option DC:	12V / 24V / 48V DC input
Consumption:	Max. 12 Watt, Standby 5 Watt
<b>■ Regulatory :</b>	
Safety:	FCC & CE certified
Environment:	RoHS2 & REACH compliant
<b>■ Environmental</b>	
Operating:	0 to 50°C
Storage:	-5 to 60°C
Relative humidity:	90%, non-condensing
Shock:	50G peak acceleration (11ms, half-sine wave)
Vibration:	58-100Hz / 0.98G (11ms / cycle)
<b>■ Product Information</b>	
Dimension (W x D x H):	443 x 171 x 44 mm / 17.4 x 6.7 x 1.73 inch
Net weight:	3 kg / 6.5 lb
<b>■ Packing Information</b>	
Dimension (W x D x H):	500 x 400 x 90 mm / 19.7 x 15.7 x 3.5 inch
Gross weight:	5 kg / 11 lb



## KVM PORT CONNECTION

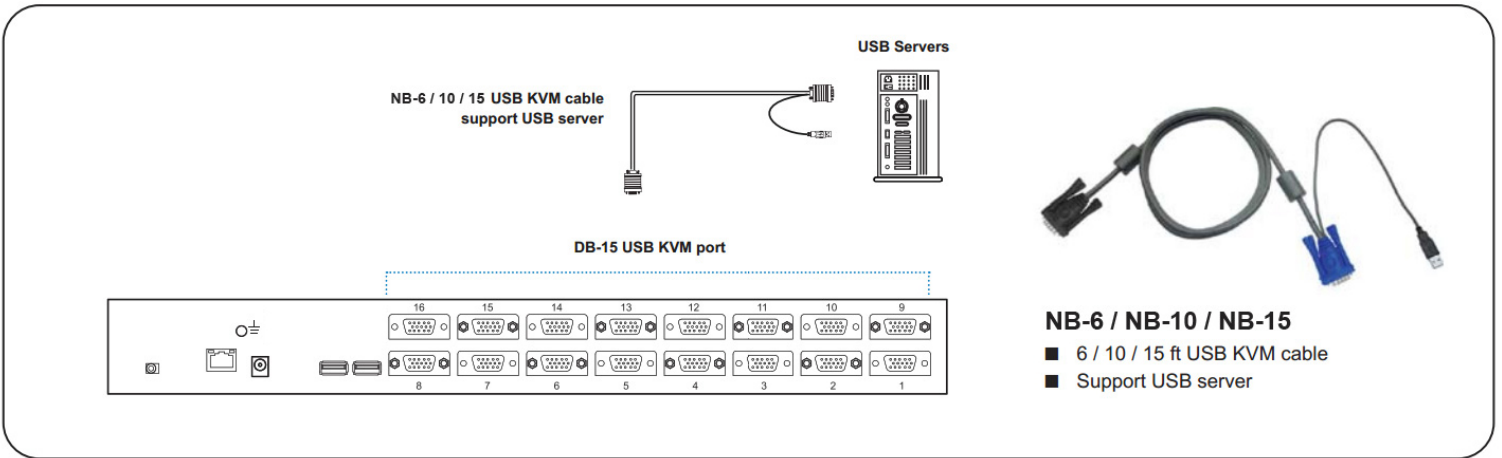

## IP & Local console connection

