

USB HUB KVM

NetView: 1U Rackmount 1000nits High-Brightness 17" Wide 1920 x 1080 LCD KVM with 104 key notepad keyboard w/ Touchpad (e), Integrated with DB-15, 16 KVM Ports + 1 User Via CAT5 Extender + 0 Users Via KVM over IP. Over Depth is 22.8 Inch. Dongles sold separately

Model: HNW117HD-B162e

FEATURES:

- 1U 17" widescreen LCD console drawer with high brightness 1000 cd/m²
- Support Full HD with 1080p resolution
- Lower power consumption, high shock & vibration resistance
- Minimum EMI emissions
- 104-key keyboard with touchpad
- New enhanced aesthetics with molded front handle
- Front USB port for device access (USB Hub KVM only)

Drawer Features & Options

- 3G / HD / SD-SDI Broadcast-grade input (w/ speaker)
- HDMI (w/ speaker)
- DC power : 12V / 24V / 48V / 110 ~ 125V

SPECIFICATIONS:

| | |
|---------------------------------------|---|
| LCD Panel | |
| Diagonal size | 17.3" widescreen TFT |
| Max. Resolution | 1920 x 1080 |
| Brightness (cd/m ²) | 1000 |
| Backlight | LED |
| Colors | 16.7M |
| Contrast Ratio (typ) | 600 : 1 |
| Viewing Angle (H/V) | 160° x 140° |
| Active area (mm) | 382 x 215 |
| MTBF (hrs) | 50,000 |
| Casing Color | Black (RAL 9005) |
| Weight (Single console | |
| Net | 10.8 kgs / 24 lbs |
| Gross | 15.8 kgs / 34.8 lbs |
| Environmental | |
| Operating | 0 to 55°C Degree |
| Storage | -20 to 60°C Degree |
| Relative humidity | 5~90%, non-condensing |
| Shock | 10G acceleration (11 ms duration) |
| Vibration | 5~500Hz 1G RMS random vibration |
| Regulatory | FCC & CE certified |
| Power | |
| Input | Auto-sensing 100 to 240VAC, 50 / 60Hz |
| Consumption | Max. 65 Watt, Standby 6 Watt |
| Product Dimensions (Single console) | |
| Product | 441.6 x 480 x 44 mm / 17.4 x 18.9 x 1.73 inch |
| Packing | 590 x 808 x 140 mm / 23.2 x 31.8 x 5.5 inch |





- Hold the handle and slide out the drawer.



- Flip up the LCD to a suitable angle



- Operate the LCD console drawer.

DIMENSION

Front View

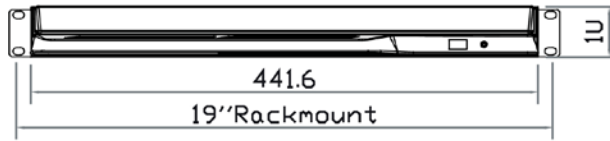

Rear View



Side View

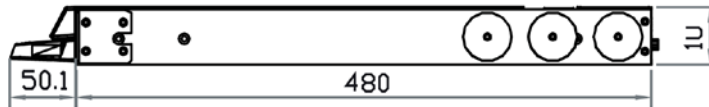

Top View

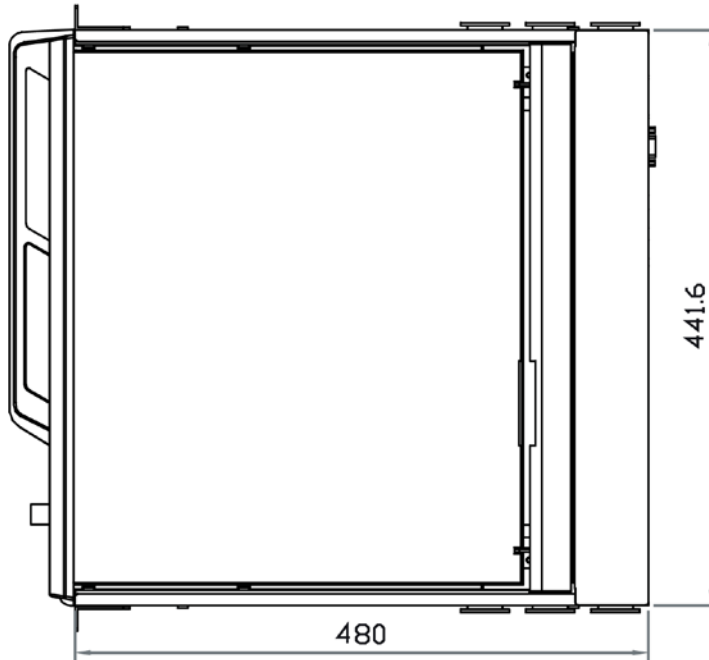

UNIT : mm
1mm = 0.03937 inch

STANDARD KEYBOARD



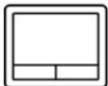
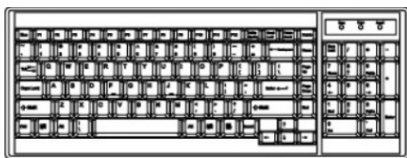













e keyboard integrated with touchpad



b keyboard integrated with trackball



Supporting layouts

| | | | | | |
|---------|---|--|--|--|---|
| America |  United States | | | | |
| EMEA |  United Kingdom |  Germany |  France |  Spain |  Norway |
| |  Italy |  Russia |  Switzerland |  Netherlands |  Portugal |
| Asia |  China |  Japan |  Korea |  Arabia |  Turkey |

STRUCTURE DIAGRAM

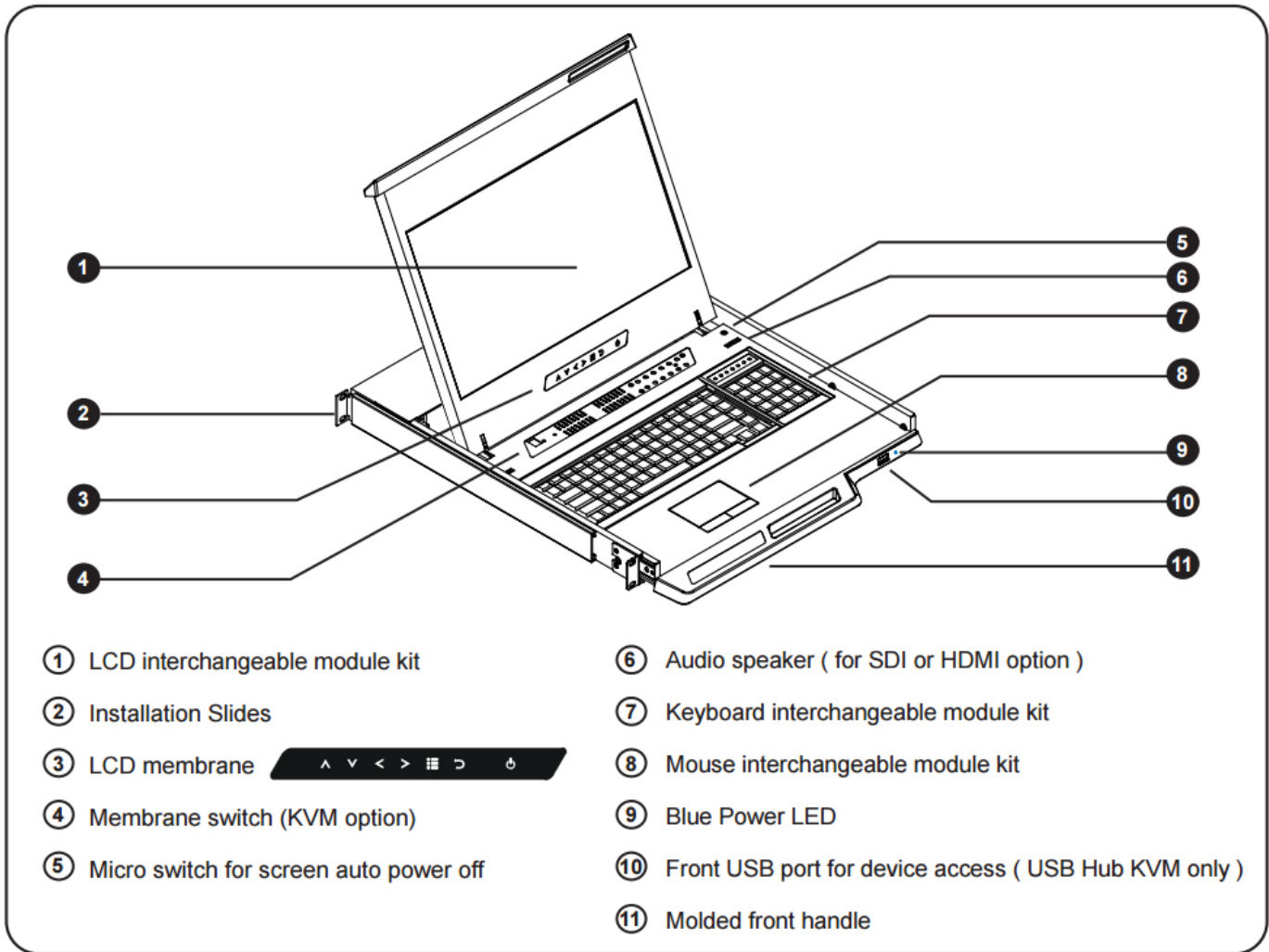

BUILT-IN USB HUB USAGE & CONNECTION

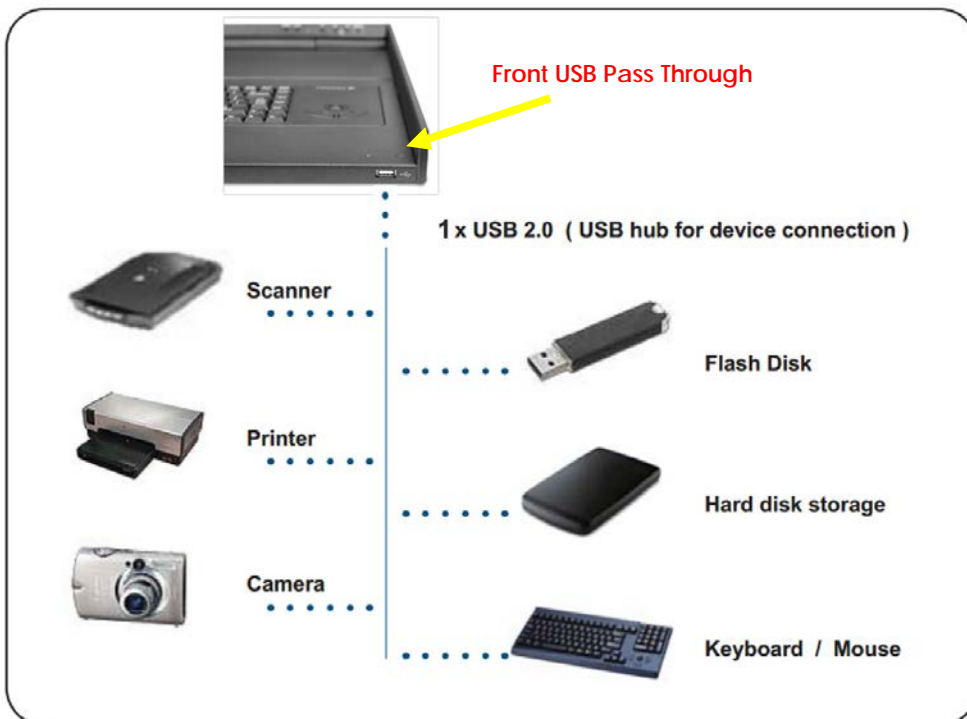

USB Hub DB-15 IP KVM Benefits

- VGA-USB DB-15 KVM with either 8 or 16 ports in 1U
- IP remote access across the world wide web
- 2 x USB 2.0 port sharing USB peripheral for computers
- Mix USB & SUN with Multi-Platform switch capability
- Support resolution up to 1920 x 1080
- SUN 1152 x 900 resolution compatible
- Hot pluggable, no software or drivers required
- Easy & quick installation

Switch Features & Options

- Multi lingual on screen display menu
- Control hardware and software systems from a remote location without physically being at the server's location
- Advanced user profiles and configurable OSD hot key combinations
- 12V, 24V and 48V DC Power options

Note: No Daisy chain function on USB Hub KVM model

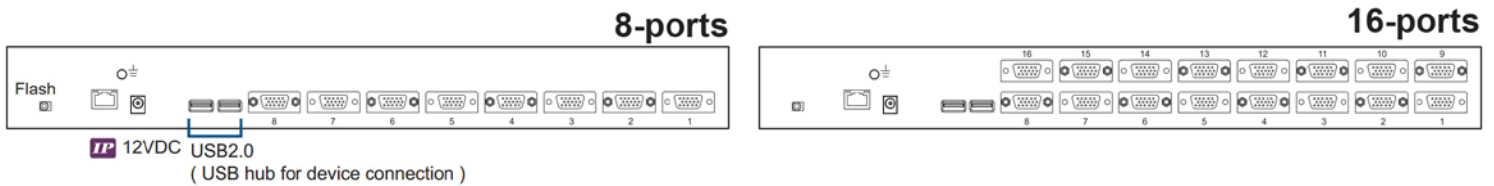

Real View



KVM SPECIFICATIONS

| | | | |
|----------------------------|---|------------------------------|--|
| ■ KVM Port | | ■ Power | |
| Number of ports: | 8 or 16 | Input: | Auto sensing 100 to 240VAC, 50 / 60 Hz |
| Connector: | DB-15 combo connector | Option DC: | 12V / 24V / 48V DC input |
| Connectivity: | Combo 2-in-1 VGA + USB KVM cable, 6, 10 or 15 feet | Consumption: | Max. 12 Watt, Standby 5 Watt |
| ■ Local Console | | ■ Regulatory : | |
| Graphic connector: | 1 x DB-15 | Safety: | FCC & CE certified |
| Resolution: | Up to 1920x1200 | Environment: | RoHS2 & REACH compliant |
| Input device: | 2 x USB type A for keyboard & mouse | ■ Environmental | |
| USB hub: | 2 x USB type A for sharing other peripheral devices among the computers | Operating: | 0 to 50°C |
| ■ IP Remote Console | | Storage: | -5 to 60°C |
| Connector: | RJ45 Ethernet | Relative humidity: | 90%, non-condensing |
| User management: | 15-user login, 1 x active user | Shock: | 50G peak acceleration (11ms, half-sine wave) |
| Network protocol: | DHCP / BOOTP / DNS | Vibration: | 58-100Hz / 0.98G (11ms / cycle) |
| Security: | SSL v3, RSA, AES, HTTP / HTTPS, CSR | ■ Product Information | |
| Resolution: | Up to 1600 x 1200 | Dimension (W x D x H): | 443 x 171 x 44 mm / 17.4 x 6.7 x 1.73 inch |
| Browser: | IE, Firefox, Safari, Netscape | Net weight: | 3 kg / 6.5 lb |
| ■ Compatibility | | ■ Packing Information | |
| Multi-platform: | Mix PCs, SUN and Mac G3 / G4 Mac / iMac | Dimension (W x D x H): | 500 x 400 x 90 mm / 19.7 x 15.7 x 3.5 inch |
| Support: | Windows 7 / Vista / 2003 / XP, Linux, Unix | Gross weight: | 5 kg / 11 lb |

KVM PORT CONNECTION

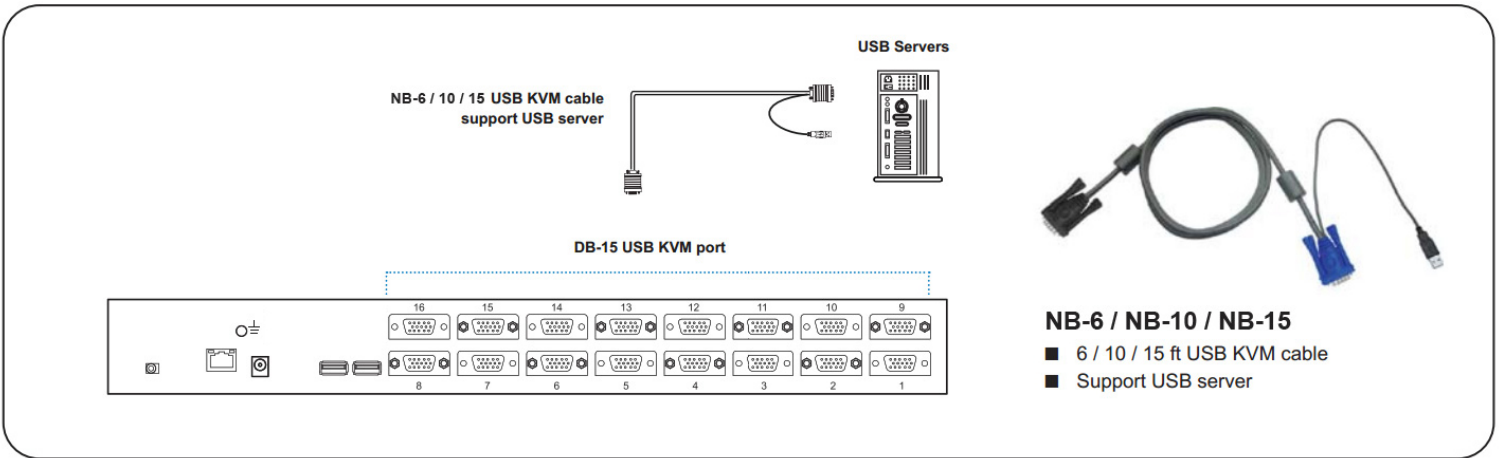

IP & Local console connection

