

CAT6 KVM

NetView:1U Rackmount 19" TFT 1280x1024 LCD KVM with 104 key notepad keyboard w/ Touchpad (e), Integrated with Combo Cat6,8 KVM Ports + 0 User Via CAT5 Extender + 0 Users Via KVM over IP. Over Depth is 19.6 Inch. Dongles sold separately

Model: NVP119C8e

FEATURES:

- 1U 19" LCD console drawer
- 104-key keyboard with either touchpad or trackball
- Short depth design 19.6 inches
- New enhanced aesthetics with molded front handle
- 2 post rack mounting available

SPECIFICATIONS:

LCD Panel	
Diagonal size	19" TFT
Max. Resolution	1280 x 1024
Brightness (cd/m2)	250
Backlight	LED
Colors	16.7M
Contrast Ratio (typ)	1000 : 1
Viewing Angle (H/V)	160° x 160°
Active area (mm)	376 x 301
MTBF (hrs)	50,000
Casing Color	Black (RAL 9005)
Weight (Single console)	
Net	12.7 kgs (27.9 lbs)
Gross	17.3 kgs (38.1 lbs)
Environmental	
Operating	0 to 50°C Degree
Storage	-5 to 60°C Degree
Relative humidity	5-90%, non-condensing
Shock	10G acceleration (11 ms duration)
Vibration	5-500Hz 1G RMS random vibration
Regulatory	cUL, FCC, CE
Power	
Input	Auto-sensing 100 to 240VAC, 50 / 60Hz
Consumption	Max. 48 Watt, Standby 5 Watt
Product Dimensions (Single console)	
Product	441.6 x 500 x 44 mm / 17.4 x 19.7 x 1.73 inch
Packing	590 x 808 x 140 mm / 23.2 x 31.8 x 5.5 inch

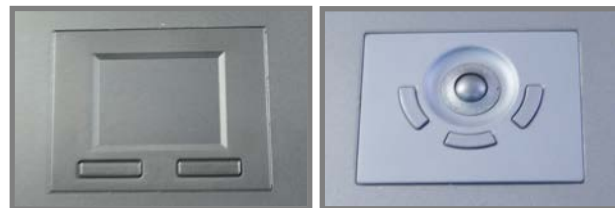

HOW TO USE THE DRAWER



- Hold the handle and slide out the drawer.



- Flip up the LCD to a suitable angle



- Operate the LCD console drawer.

DIMENSION

Front View

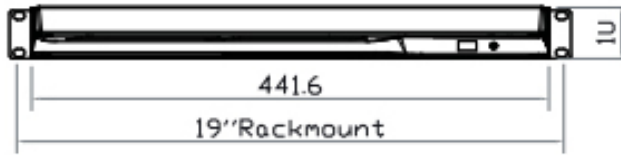

Rear View



UNIT : mm
1mm = 0.03937 inch

Side View



Top View

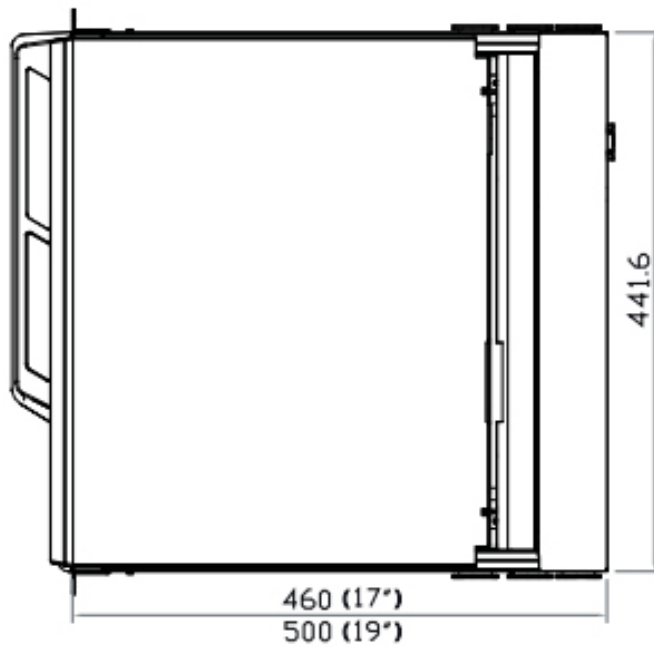

STANDARD KEYBOARD

















e keyboard integrated with touchpad



b keyboard integrated with trackball



Supporting layouts

America	 United States				
EMEA					
	United Kingdom	Germany	France	Spain	Norway
Asia					
	Italy	Russia	Switzerland	Netherlands	Portugal
Asia					
	China	Japan	Korea	Arabia	Turkey

STRUCTURE DIAGRAM



KVM PORT & CAT6 DONGLE CONNECTION



IF-DUSBD DVI-USB dongle

- To connect DVI-D connector to the computer's video card
- To connect USB connector to the computer's USB port



IF-DUSB VGA-USB dongle

- To connect DB-15 connector to the computer's video card
- To connect USB connector to the computer's USB port



IF-DPS2 VGA-PS/2 dongle

- To connect DB-15 connector to the computer's video card
- To connect PS/2 keyboard connector to the computer's keyboard port
- To connect PS/2 mouse connector to the computer's mouse port

Cat6 Dongle	EDID Resolution Hard-coded	Resolutions Capable			
		4:3			16:10
		1024 x 768	1280 x 1024	1600 x 1200	1440 x 900
IF-DPS2	1600 x 1200	✓	✓	✓	✓*
IF-DUSB	1600 x 1200	✓	✓	✓	✓*
IF-DUSBD	1280 x 1024	✓	✓	✗	✗

* Requires the user to enable showing unsupported resolutions via the target computer's video adapter settings (effectively ignoring the DDC / EDID)

KVM CASCADE

- Cascade up to 8 levels, 256 servers
- Cascading multiple KVM with CBC-6 cascade cable

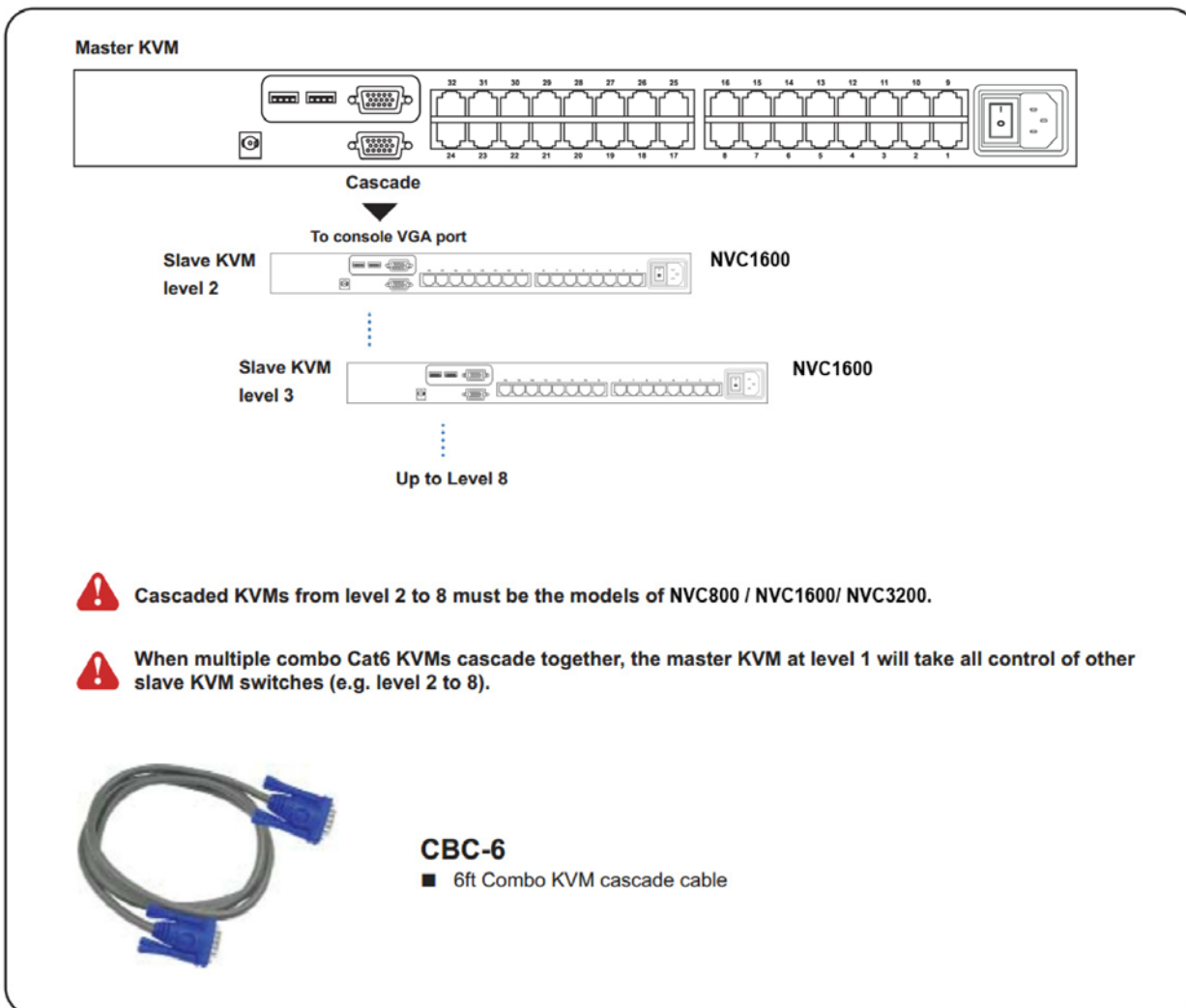

Combo Cat6 KVM Benefits

- Combo Cat6 KVM with either 8, 16 or 32 ports in 1U
- Up to 40 meters between your servers & KVM ports
- Cascade switches up to 8 levels & Mix switches between Cat6 & Combo DB-15 KVM
- Support DVI-USB, VGA-USB & VGA-PS/2 server interface
- Mix PS/2, USB & SUN with Multi-Platform switch capability

Switch Features & Options

- Multi lingual on screen display menu
- Advanced user profiles and configurable OSD hot key combinations
- Dual power with failover
- DC power options : 12V / 24V / 48V / 110 ~ 125V



KVM SPECIFICATIONS

■ KVM Port	
Number of ports:	8, 16 or 32
Connector:	RJ-45
Connectivity:	DVI-D / VGA connector dongle up to 40 meters (132 feet) via Cat6 / Cat5 cable
■ Management	
Multilingual OSD:	English, France, German, Spanish, Italian, Russian, Simplified Chinese, Japanese
Hotkey combination:	Scroll-lock, Cap-lock, Num-lock, Alt, Ctrl & Win
Security:	Password enable & disable, up to 8 users profile for port access
PC Selection:	Front button, OSD menu & hotkey
■ Local Console	
Graphic Connector:	1 x DB-15 VGA
Resolution:	Up to 1600 x 1200
Input device:	2 x USB type A for keyboard & mouse
Resolution support:	4:3 - max. 1600 x 1200 16:10 - max. 1440 x 900
■ Expansion:	Up to 256 servers by 8-level cascade
■ Compatibility	
Multi-platform:	Mix PCs, SUN and Mac G3 / G4 Mac / iMac
Support:	Windows 7 / Vista / 2003 / XP, Linux, Unix
■ Power	
Input:	Auto sensing 100 to 240VAC, 50 / 60 Hz OR AC / DC power adapter 12V@3.3A (optional)
Option DC:	12V / 24V / 48V / 110 ~ 125V DC input
Consumption:	Max. 24 Watt, Standby 5 Watt

■ Regulatory :	
Safety:	cUL, FCC & CE certified
Environment:	RoHS2 & REACH compliant
■ Environmental	
Operating:	0 to 50°C
Storage:	-5 to 60°C
Relative humidity:	90%, non-condensing
Shock:	50G peak acceleration (11ms, half-sine wave)
Vibration:	58-100Hz / 0.98G (11ms / cycle)
■ Product Information	
Dimension (W x D x H):	443 x 171 x 44 mm / 17.4 x 6.7 x 1.73 inch
Net weight:	3 kg / 6.5 lb
■ Packing Information	
Dimension (W x D x H):	500 x 400 x 90 mm / 19.7 x 15.7 x 3.5 inch
Gross weight:	5 kg / 11 lb