

CAT6 KVM

NetView:1U Rackmount 20" TFT 1600x1200 LCD KVM with 104 key notepad keyboard w/ Touchpad (e), Integrated with Combo Cat6,16 KVM Ports + 1 User Via CAT5 Extender + 0 Users Via KVM over IP. Over Depth is 26 Inch. Dongles sold separately

Model: NVP120CCE16e



FEATURES:

- 1U 20" LCD console drawer
- Ultra high resolution 1600 x 1200
- 104-key keyboard with touchpad
- Short depth design of 650mm(26 inch)Deep
- Enhanced aesthetics with molded front handle and two point lock

SPECIFICATIONS:

LCD Panel	
Diagonal size	20.1" TFT
Max. Resolution	1600 x 1200
Brightness (cd/m2)	300
Backlight	CCFL
Colors	16.7M
Contrast Ratio (typ)	800 : 1
Viewing Angle (H/V)	178° x 178°
Active area (mm)	408 x 306
MTBF (hrs)	45,000
Casing Color	Black (RAL 9005)
Weight (Single console)	
Net	14.5 kgs (31.9 lbs)
Gross	22 kgs (48.4 lbs)
Environmental	
Operating	0 to 50°C Degree
Storage	-5 to 60°C Degree
Relative humidity	5-90%, non-condensing
Shock	10G acceleration (11 ms duration)
Vibration	5-500Hz 1G RMS random vibration
Regulatory	FCC, CE
Power	
Input	Auto-sensing 100 to 240VAC, 50 / 60Hz
Consumption	Max. 48 Watt, Standby 5 Watt
Product Dimensions (Single console)	
Product	439.6 x 650 x 44 mm / 23.4 x 25.6 x 1.73 inch
Packing	595 x 860 x 140 mm / 23.4 x 33.9 x 5.5 in



HOW TO USE THE DRAWER



- Hold the handle and slide out the drawer.



- Flip up the LCD to a suitable angle



- Operate the LCD console drawer.

DIMENSION

Front View

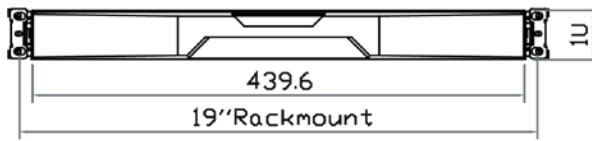

Rear View



Side View

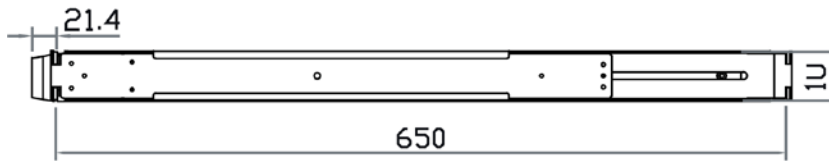

UNIT : mm
1mm = 0.03937 inch

Top View

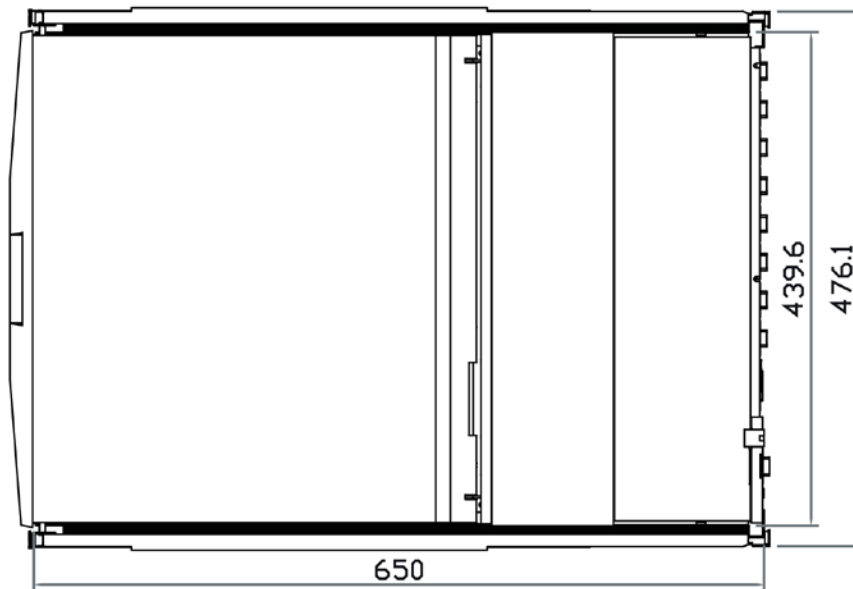

STANDARD KEYBOARD



G keyboard integrated with touchpad

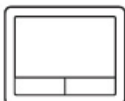
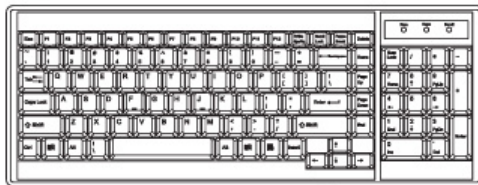

Supporting layouts

America					
	United States				
EMEA					
	United Kingdom	Germany	France	Spain	Norway
	Italy	Russia	Switzerland	Netherlands	Portugal
	Asia				
	China	Japan	Korea	Arabia	Turkey

STRUCTURE DIAGRAM

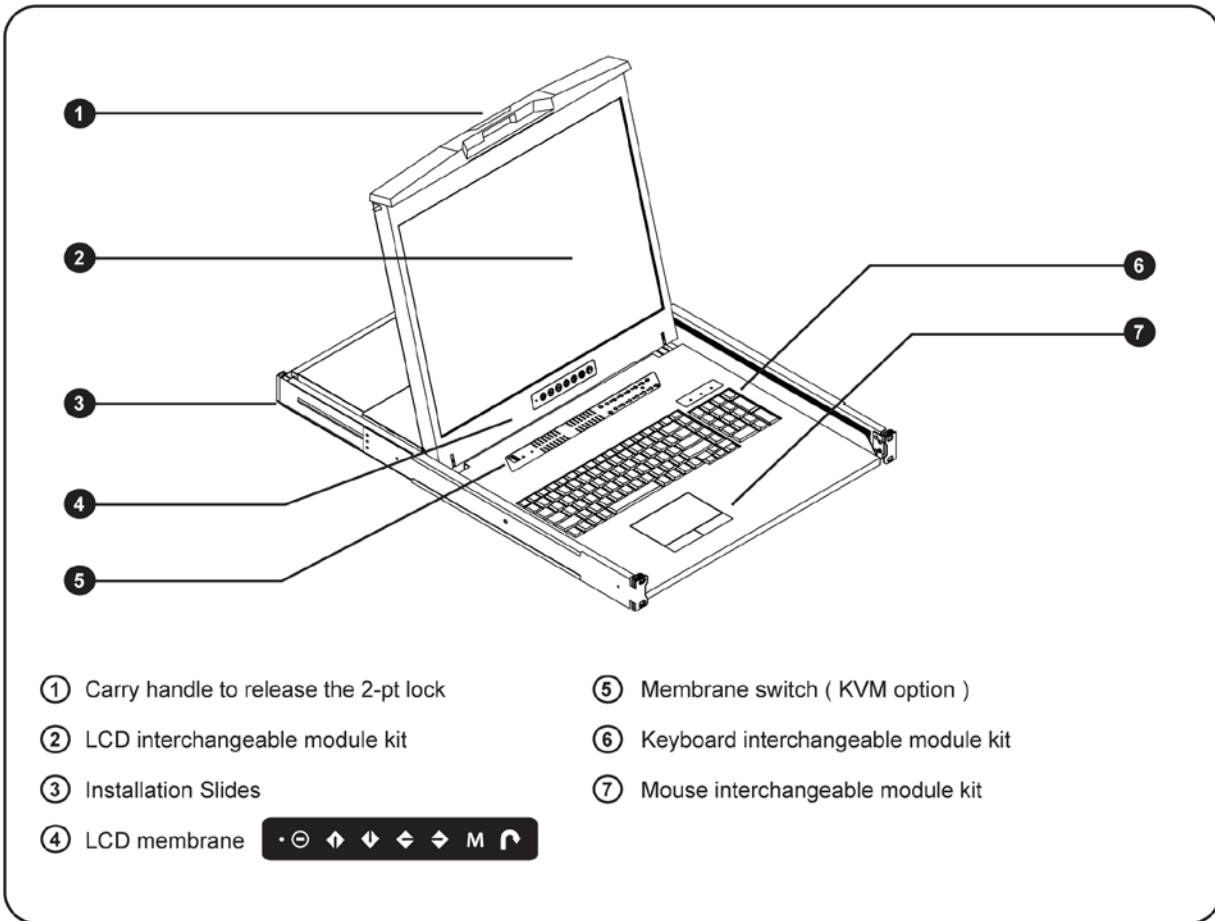

KVM PORT & CAT6 DONGLE CONNECTION

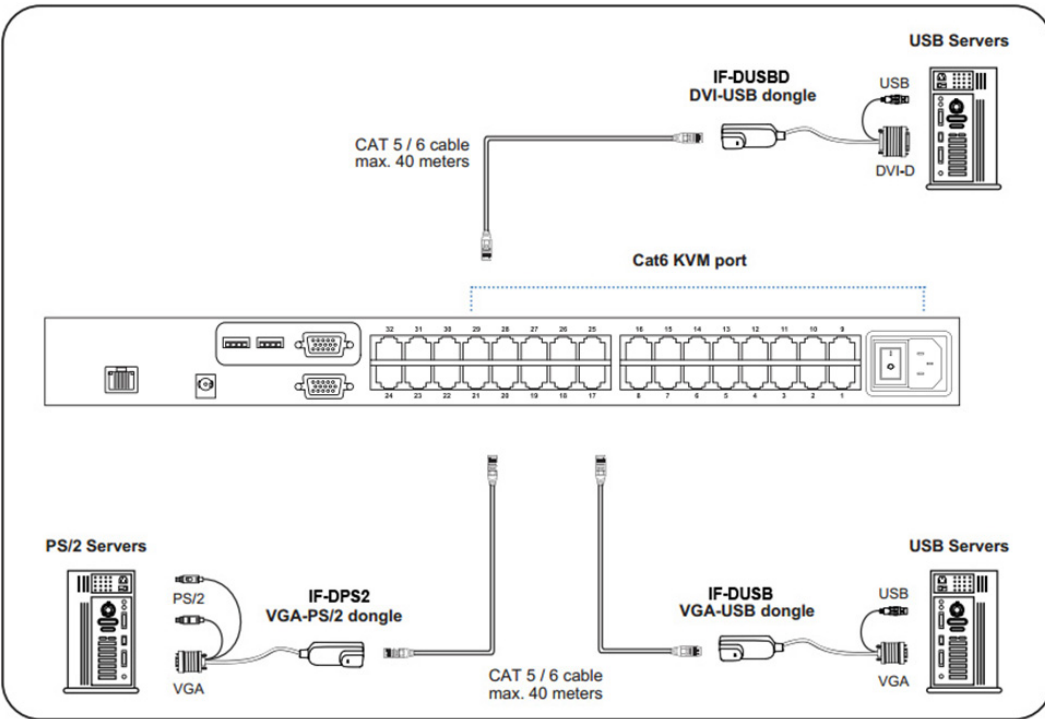

IF-DUSBD DVI-USB dongle

- To connect DVI-D connector to the computer's video card
- To connect USB connector to the computer's USB port



IF-DUSB VGA-USB dongle

- To connect DB-15 connector to the computer's video card
- To connect USB connector to the computer's USB port



IF-DPS2 VGA-PS/2 dongle

- To connect DB-15 connector to the computer's video card
- To connect PS/2 keyboard connector to the computer's keyboard port
- To connect PS/2 mouse connector to the computer's mouse port

Cat6 Dongle	EDID Resolution Hard-coded	Resolutions Capable			
		4:3			16:10
		1024 x 768	1280 x 1024	1600 x 1200	1440 x 900
IF-DPS2	1600 x 1200	✓	✓	✓	✓*
IF-DUSB	1600 x 1200	✓	✓	✓	✓*
IF-DUSBD	1280 x 1024	✓	✓	✗	✗

* Requires the user to enable showing unsupported resolutions via the target computer's video adapter settings (effectively ignoring the DDC / EDID)

REMOTE & LOCAL CONSOLE CONNECTION



Combo Cat6 2-console KVM Benefits

- Combo Cat6 KVM with either 8, 16 or 32 ports in 1U
- Up to 40 meters between your servers & KVM ports
- Remote access up to 150 meters
- Cascade switches up to 8 levels & Mix switches between Cat6 & Combo DB-15 KVM
- Support DVI-USB, VGA-USB & VGA-PS/2 server interface
- Mix PS/2, USB & SUN with Multi-Platform switch capability

Switch Features & Options

- Multi lingual on screen display menu
- Advanced user profiles and configurable OSD hot key combinations
- Dual power with failover
- 12V, 24V and 48V DC Power options



NVCCE800

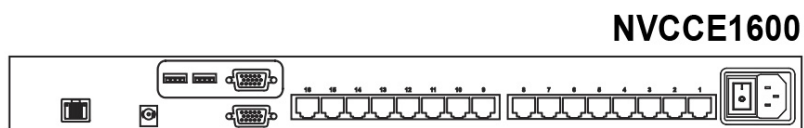

NVCCE1600

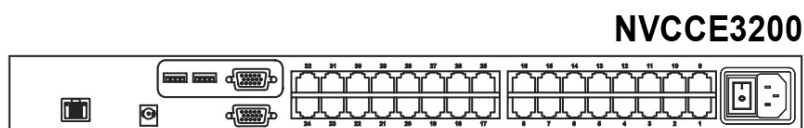

NVCCE3200

KVM SPECIFICATIONS

■ KVM Port	
Number of ports:	8, 16 or 32
Connector:	RJ-45
Connectivity:	DVI-D / VGA connector dangle up to 40 meters (132 feet) via Cat6 / Cat5 cable
■ Local Console	
Graphic Connector:	1 x DB-15 VGA
Resolution:	Up to 1600 x 1200
Input device:	2 x USB type A for keyboard & mouse
Remote I/O:	RJ45 via Cat5 / Cat5e / Cat6 cable up to 150m
Compensation:	Auto adjust for cable length
Resolution support:	4:3 - max. 1600 x 1200 16:10 - max. 1440 x 900
■ Expansion:	Up to 256 servers by 8-level cascade
■ Compatibility	
Multi-platform:	Mix PCs, SUN and Mac G3 / G4 Mac / iMac
Support:	Windows 7 / Vista / 2003 / XP, Linux, Unix
■ Power	
Input:	Auto sensing 100 to 240VAC, 50 / 60 Hz OR AC / DC power adapter 12V@3.3A (optional)
Option DC:	12V / 24V / 48V DC input
Consumption:	Max. 48 Watt, Standby 5 Watt

■ Regulatory :	
Safety:	cUL, FCC & CE certified
Environment:	RoHS2 & REACH compliant
■ Environmental	
Operating:	0 to 50°C
Storage:	-5 to 60°C
Relative humidity:	90%, non-condensing
Shock:	50G peak acceleration (11ms, half-sine wave)
Vibration:	58-100Hz / 0.98G (11ms / cycle)
■ Product Information	
Dimension (W x D x H):	443 x 171 x 44 mm / 17.4 x 6.7 x 1.73 inch
Net weight:	3 kg / 6.5 lb
■ Packing Information	
Dimension (W x D x H):	500 x 400 x 90 mm / 19.7 x 15.7 x 3.5 inch
Gross weight:	5 kg / 11 lb

KVM CASCADE

- Cascade up to 8 levels, 256 servers
- Cascading multiple KVM with CBC-6 cascade cable

Master KVM

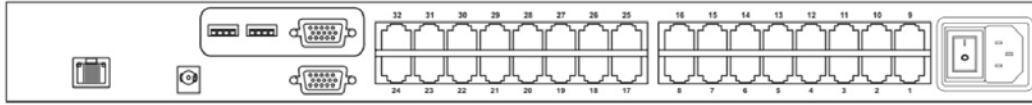

Cascade

To console VGA port

Slave KVM
level 2



NVC1600

Slave KVM
level 3



NVC1600

Up to Level 8



Cascaded KVMs from level 2 to 8 must be the models of NVC800 / NVC1600/ NVC3200.



When multiple combo Cat6 KVMs cascade together, the master KVM at level 1 will take all control of other slave KVM switches (e.g. level 2 to 8).



CBC-6

- 6ft Combo KVM cascade cable