

CAT6 KVM

NetView:1U Rackmount 20" TFT 1600x1200 LCD KVM with 104 key notepad keyboard w/ Touchpad (e), Integrated with Matrix Cat6,16 KVM Ports + 3 User Via CAT5 Extender + 0 Users Via KVM over IP. Over Depth is 26 Inch. Dongles sold separately



Model: NVP120MC0316e

FEATURES:

- 1U 20" LCD console drawer
- Ultra high resolution 1600 x 1200
- 104-key keyboard with touchpad
- Short depth design of 650mm(26 inch)Deep
- Enhanced aesthetics with molded front handle and two point lock

SPECIFICATIONS:

LCD Panel	
Diagonal size	20.1" TFT
Max. Resolution	1600 x 1200
Brightness (cd/m2)	300
Backlight	CCFL
Colors	16.7M
Contrast Ratio (typ)	800 : 1
Viewing Angle (H/V)	178° x 178°
Active area (mm)	408 x 306
MTBF (hrs)	45,000
Casing Color	Black (RAL 9005)
Weight (Single console)	
Net	14.5 kgs (31.9 lbs)
Gross	22 kgs (48.4 lbs)
Environmental	
Operating	0 to 50°C Degree
Storage	-5 to 60°C Degree
Relative humidity	5-90%, non-condensing
Shock	10G acceleration (11 ms duration)
Vibration	5-500Hz 1G RMS random vibration
Regulatory	FCC, CE
Power	
Input	Auto-sensing 100 to 240VAC, 50 / 60Hz
Consumption	Max. 48 Watt, Standby 5 Watt
Product Dimensions (Single console)	
Product	439.6 x 650 x 44 mm / 23.4 x 25.6 x 1.73 inch
Packing	595 x 860 x 140 mm / 23.4 x 33.9 x 5.5 in

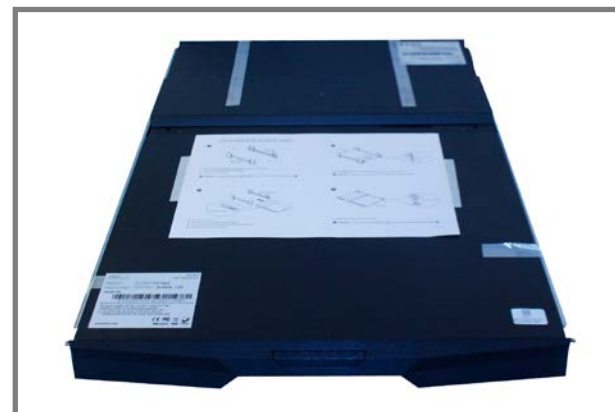

HOW TO USE THE DRAWER



- Hold the handle and slide out the drawer.



- Flip up the LCD to a suitable angle



- Operate the LCD console drawer.

DIMENSION

Front View

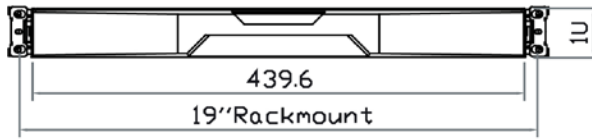

Rear View



Side View

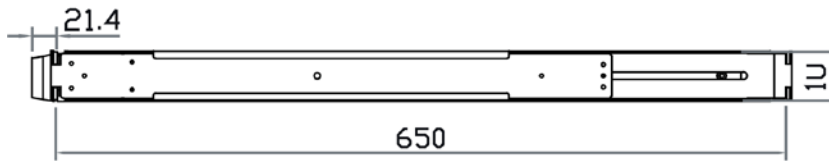

UNIT : mm
1mm = 0.03937 inch

Top View

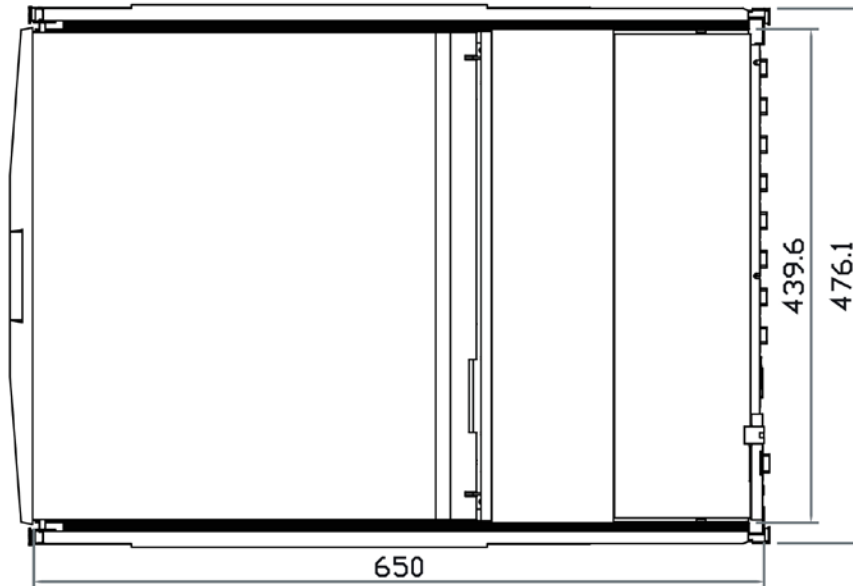

STANDARD KEYBOARD



G keyboard integrated with touchpad

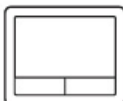
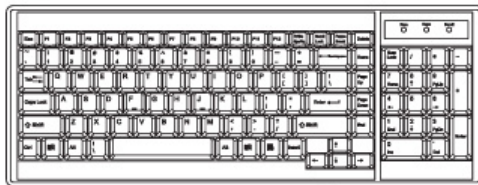

Supporting layouts

America					
	United States				
EMEA					
	United Kingdom	Germany	France	Spain	Norway
	Italy	Russia	Switzerland	Netherlands	Portugal
	Asia				
	China	Japan	Korea	Arabia	Turkey

STRUCTURE DIAGRAM

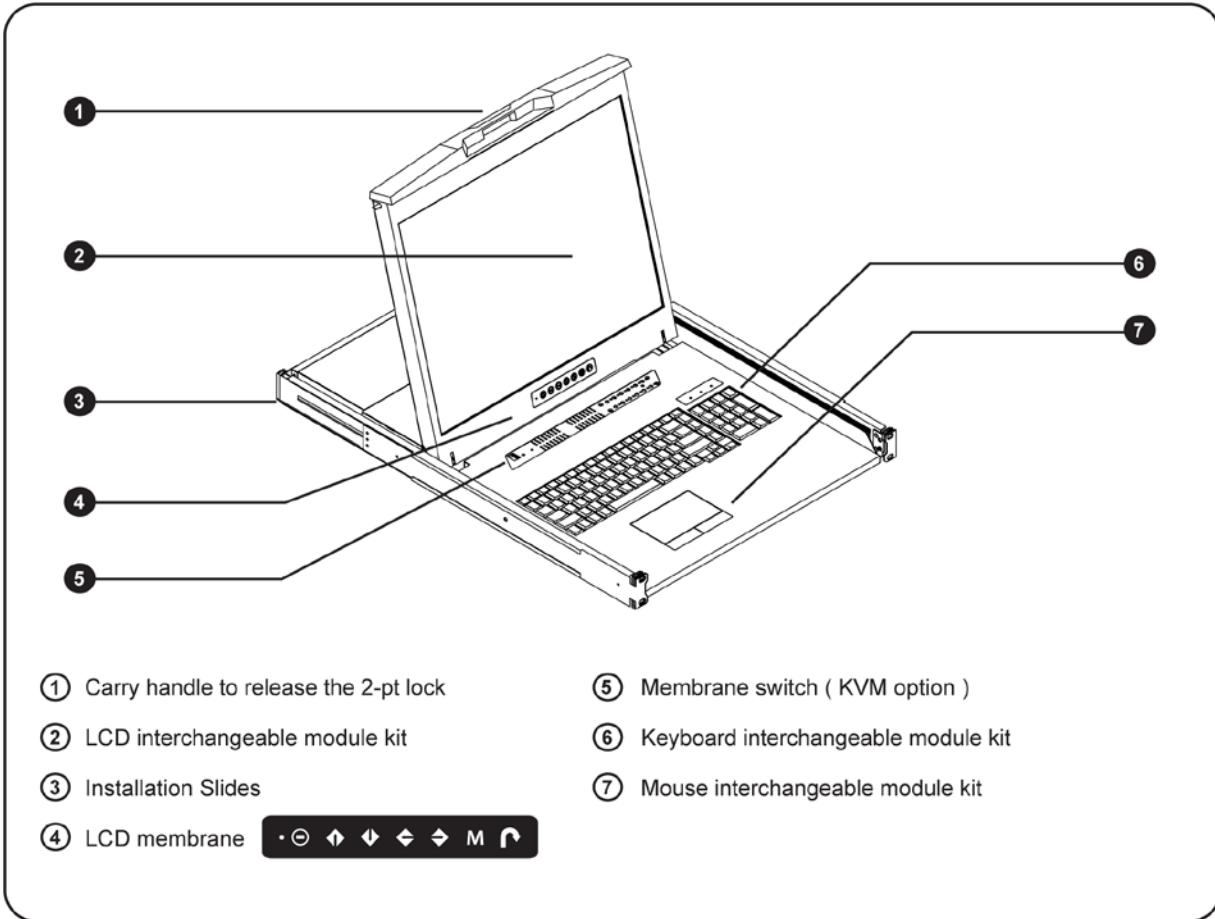

KVM PORT & CAT6 DONGLE CONNECTION

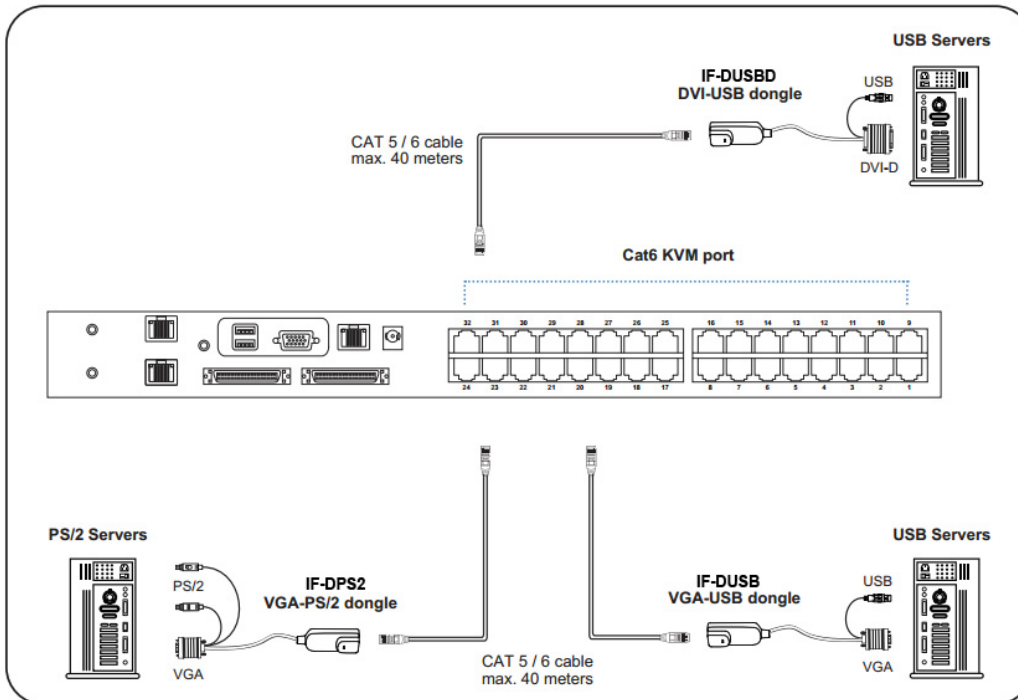

IF-DUSBD DVI-USB dongle

- To connect DVI-D connector to the computer's video card
- To connect USB connector to the computer's USB port



IF-DUSB VGA-USB dongle

- To connect DB-15 connector to the computer's video card
- To connect USB connector to the computer's USB port



IF-DPS2 VGA-PS/2 dongle

- To connect DB-15 connector to the computer's video card
- To connect PS/2 keyboard connector to the computer's keyboard port
- To connect PS/2 mouse connector to the computer's mouse port

Cat6 Dongle	EDID Resolution Hard-coded	Resolutions Capable			
		4:3			16:10
		1024 x 768	1280 x 1024	1600 x 1200	1440 x 900
IF-DPS2	1600 x 1200	✓	✓	✓	✓*
IF-DUSB	1600 x 1200	✓	✓	✓	✓*
IF-DUSBD	1280 x 1024	✓	✓	✗	✗

* Requires the user to enable showing unsupported resolutions via the target computer's video adapter settings (effectively ignoring the DDC / EDID)

LOCAL CONSOLE & REMOTE CONSOLE CONNECTION



Matrix Cat6 KVM Benefits

- Efficient system management with simultaneous multi-user access
- Capable of connecting 32 or 16 servers per device in 1U
- Support DVI-USB, VGA-USB & VGA-PS/2 server interface
- Increased distance of 40m between your server & KVM
- Enhanced Cat6 cable management with remote access up to 150m

Switch Features & Options

- Provide a diversity of console to access servers independently and simultaneously
- Use of the RJ45 Cat6 interface allows for a higher number of ports in smaller density
- Greater distances between your switch and servers allow enhanced data center rack layouts
- Multi lingual on screen display menu
- Advanced user profiles and configurable OSD hot key combinations

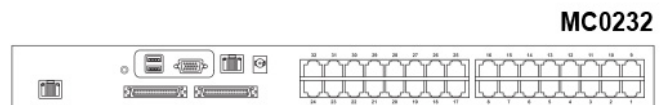
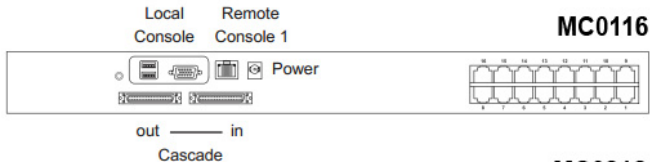

KVM SPECIFICATIONS

■ KVM Port	
Number of ports:	16 or 32
Connector:	RJ-45
Connectivity:	DVI-D / VGA connector dongle up to 40 meters (132 feet) via Cat6 / Cat5 cable
■ Local Console	
Monitor port:	1 x DB15-pin VGA, up to 1600 x 1200
Keyboard & mouse port:	2 x USB type connector for keyboard & mouse
Resolution support:	4:3 - max. 1600x1200 16:10 - max. 1440x900
■ Cat6 Remote Console	
Number of remote port:	1 for MC0116 / MC0132 2 for MC0216 / MC0232 3 for MC0316 / MC0332
Monitor port:	DB15-pin VGA, up to 1600 x 1200
Keyboard & mouse port:	2 x USB type connector for keyboard & mouse
Remote I/O:	RJ45 via Cat5 / Cat5e / Cat6 cable up to 500 feet
Resolution support:	4:3 - max. 1600x1200 16:10 - max. 1440x900
■ Expansion:	Up to 256 servers by 8-level cascade
■ Compatibility	
Multi-platform:	Mix PCs, SUN and Mac G3 / G4 Mac / iMac
Support:	Windows 7 / Vista / 2003 / XP, Linux, Unix

■ Power	
Input:	AC power adapter
Consumption:	Max. 48 Watt, Standby 5 Watt
■ Regulatory :	
Safety:	cUL, FCC & CE certified
Environment:	RoHS2 & REACH compliant
■ Environmental	
Operating:	0 to 50°C
Storage:	-5 to 60°C
Relative humidity:	90%, non-condensing
Shock:	50G peak acceleration (11ms, half-sine)
Vibration:	58-100Hz / 0.98G (11ms / cycle)
■ Product Information	
Dimension (W x D x H):	443 x 171 x 44 mm / 17.4 x 6.7 x 1.73 inch
Net weight:	3 kg / 6.5 lb
■ Packing Information	
Dimension (W x D x H):	500 x 400 x 90 mm / 19.7 x 15.7 x 3.5 inch
Gross weight:	5 kg / 11 lb

KVM CASCADE

- Cascade up to 8 levels, 256 servers
- Cascading multiple KVM with CMC-8 cascade cable



Cascaded KVMs from level 2 to 8 must be the models of MC0116 / MC0132 or M018 / M0116.



When multiple matrix KVMs cascade together, the master KVM at level 1 will take all control of other slave KVM switches (e.g. level 2 to 8).



The slave matrix KVM will be as a port expansion module of the master matrix KVM, the original remote console on slave KVM will be sacrificed and disabled.



CMC-8

- 8ft Matrix KVM cascade cable