

CAT6 KVM

NetView:2U Rackmount 17" TFT 1280x1024 LCD KVM with 104 key notepad keyboard w/ Trackball (b), Integrated with Matrix Cat6,16 KVM Ports + 1 User Via CAT5 Extender + 1 Users Via KVM over IP. Over Depth is 19 Inch. Dongles sold separately

Model: NVP2417MC1116b

FEATURES:

- 2U dual slide 17" LCD console drawer
- 104-key keyboard with either touchpad or trackball
- Short depth design of 480mm(19 inch)Deep
- New enhanced aesthetics with molded front handle
- 2 post rack mounting available

SPECIFICATIONS:

| | |
|--|--|
| LCD Panel | |
| Diagonal size | 17" TFT |
| Max. Resolution | 1280 x 1024 |
| Brightness (cd/m2) | 250 |
| Backlight | CCFL |
| Colors | 16.7M |
| Contrast Ratio (typ) | 1000 : 1 |
| Viewing Angle (H/V) | 160° x 160° |
| Active area (mm) | 338 x 270 |
| MTBF (hrs) | 50,000 |
| Casing Color | Black (RAL 9005) |
| Weight (Single console) | |
| Net | 20.4 kgs (44.9 lbs) |
| Gross | 24.8 kgs (54.6 lbs) |
| Environmental | |
| Operating | 0 to 50°C Degree |
| Storage | -5 to 60°C Degree |
| Relative humidity | 5~90%, non-condensing |
| Shock | 10G acceleration (11 ms duration) |
| Vibration | 5~500Hz 1G RMS random vibration |
| Regulatory | FCC, CE |
| Power | |
| Input | Auto-sensing 100 to 240VAC, 50 / 60Hz |
| Consumption | Max. 48 Watt, Standby 5 Watt |
| Product Dimensions (Single console) | |
| Product | 441.6 x 480 x 88 mm / 17.4 x 18.1 x 3.5 inch |
| Packing | 585 x 620 x 190 mm / 23 x 24.4 x 7.5 inch |
| Product Dimensions (with KVM) | |
| Product | 441.6 x 480 x 88 mm / 17.4 x 18.9 x 3.5 inch |
| Packing | 585 x 620 x 190 mm / 23 x 24.4 x 7.5 inch |



DIMENSION

Front View



Rear View



Side View



Top View



UNIT : mm
1mm = 0.03937 inch

STANDARD KEYBOARD



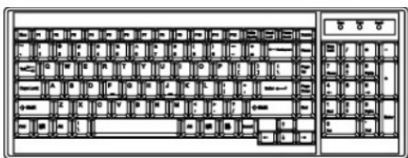













e keyboard integrated with touchpad



b keyboard integrated with trackball



Supporting layouts

| | | | | | |
|---------|--|---|---|---|--|
| America |  United States | | | | |
| EMEA |  United Kingdom |  Germany |  France |  Spain |  Norway |
| |  Italy |  Russia |  Switzerland |  Netherlands |  Portugal |
| Asia |  China |  Japan |  Korea |  Arabia |  Turkey |

STRUCTURE DIAGRAM



KVM PORT & CAT6 DONGLE CONNECTION

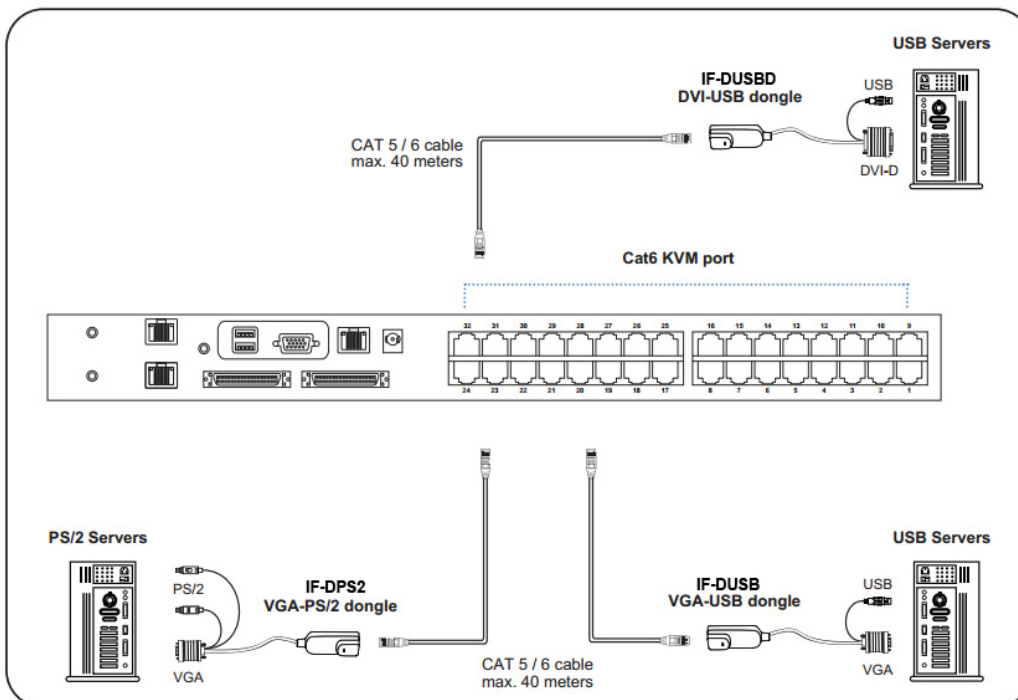

IF-DUSBD DVI-USB dongle

- To connect DVI-D connector to the computer's video card
- To connect USB connector to the computer's USB port



IF-DUSB VGA-USB dongle

- To connect DB-15 connector to the computer's video card
- To connect USB connector to the computer's USB port



IF-DPS2 VGA-PS/2 dongle

- To connect DB-15 connector to the computer's video card
- To connect PS/2 keyboard connector to the computer's keyboard port
- To connect PS/2 mouse connector to the computer's mouse port

| Cat6 Dongle | EDID Resolution Hard-coded | Resolutions Capable | | | |
|-------------|----------------------------------|---------------------|-------------|-------------|------------|
| | | 4:3 | | | 16:10 |
| | | 1024 x 768 | 1280 x 1024 | 1600 x 1200 | 1440 x 900 |
| IF-DPS2 | 1600 x 1200 | ✓ | ✓ | ✓ | ✓* |
| IF-DUSB | 1600 x 1200 | ✓ | ✓ | ✓ | ✓* |
| IF-DUSBD | 1280 x 1024 | ✓ | ✓ | ✗ | ✗ |

* Requires the user to enable showing unsupported resolutions via the target computer's video adapter settings (effectively ignoring the DDC / EDID)

IP, REMOTE & LOCAL CONSOLE CONNECTION



Matrix Cat6 IP KVM Benefits

- Secure IP remote user access across the world wide web
- Efficient system management with simultaneous multi-user access
- Capable of connecting 32 or 16 servers per device in 1U
- Support DVI-USB, VGA-USB & VGA-PS/2 server interface
- Up to 40 meters between your server & KVM switch
- Enhanced Cat6 cable management with remote access up to 150m

Switch Features & Options

- Provide a diversity of console to access servers independently and simultaneously
- Use of the RJ45 Cat6 interface allows for a higher number of ports in smaller density
- Greater distances between your switch and servers allow enhanced data center rack layouts
- Multi lingual on screen display menu
- Advanced user profiles and configurable OSD hot key combinations

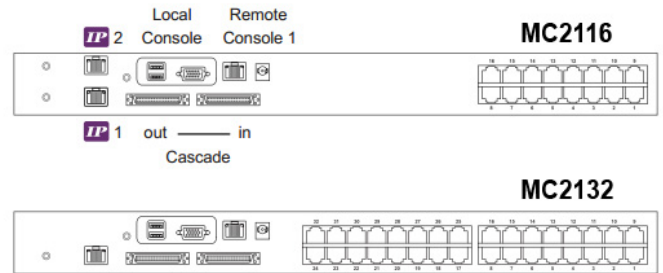
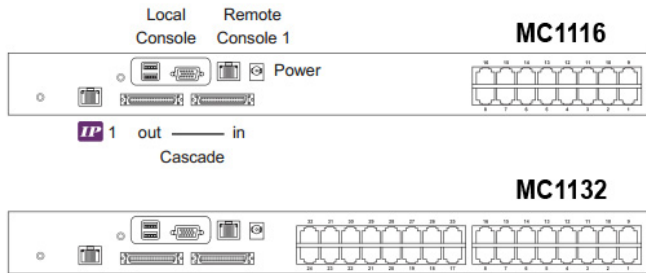

KVM SPECIFICATIONS

| | |
|------------------------------|---|
| ■ KVM Port | |
| Number of ports: | 16 or 32 |
| Connector: | RJ-45 |
| Connectivity: | DVI-D / VGA connector dongle up to 40 meters (132 feet) via Cat6 / Cat5 cable |
| ■ Local Console | |
| Monitor port: | DB15-pin VGA |
| Keyboard & mouse port: | 2 x USB type connector for keyboard & mouse |
| Resolution support: | 4:3 - max. 1600x1200 16:10 - max. 1440x900 |
| ■ Cat6 Remote Console | |
| Number of remote port: | 1 |
| Monitor port: | DB15-pin VGA |
| Keyboard & mouse port: | 2 x USB type connector for keyboard & mouse |
| Remote I/O: | RJ45 via Cat5 / Cat5e / Cat6 cable up to 500 feet |
| Resolution support: | 4:3 -max. 1600x1200 16:10-max. 1440x900 |
| ■ IP Remote Console | |
| Number of IP console: | 1 for MC1116 / MC1132 2 for MC2116 / MC2132 |
| User management: | 15-user login, 1 x active user |
| Browser: | Internet Explorer, Firefox, Safari |
| Security: | SSL v3, RSA, AES, HTTP / HTTPS, CSR |
| IP Access: | RJ45 Ethernet per IP console |
| Resolution support: | 4:3-max. 1600x1200 |

| | |
|------------------------------|--|
| ■ Expansion: | Up to 256 servers by 8-level cascade |
| ■ Compatibility: | |
| Multi-platform: | Mix PCs, SUN and Mac G3 / G4 Mac / iMac |
| Support: | Windows 7 / Vista / 2003 / XP, Linux, Unix |
| ■ Power | |
| Input: | AC power adapter |
| Consumption: | Max. 48 Watt, Standby 5 Watt |
| ■ Regulatory : | |
| Safety: | cUL, FCC & CE certified |
| Environment: | RoHS2 & REACH compliant |
| ■ Environmental | |
| Operating: | 0 to 50°C |
| Storage: | -5 to 60°C |
| Relative humidity: | 90%, non-condensing |
| Shock: | 50G peak acceleration (11ms, half-sine) |
| Vibration: | 58-100Hz / 0.98G (11ms / cycle) |
| ■ Product Information | |
| Dimension (W x D x H): | 443 x 171 x 44 mm / 17.4 x 6.7 x 1.73 inch |
| Net weight: | 3 kg / 6.5 lb |
| ■ Packing Information | |
| Dimension (W x D x H): | 500 x400 x90 mm / 19.7 x 15.7x3.5 inch |
| Gross weight: | 5 kg / 11 lb |

KVM CASCADE

- Cascade up to 8 levels, 256 servers
- Cascading multiple KVM with CMC-8 cascade cable



Cascaded KVMs from level 2 to 8 must be the models of MC0116 / MC0132 or M018 / M0116.



When multiple matrix KVMs cascade together, the master KVM at level 1 will take all control of other slave KVM switches (e.g. level 2 to 8).



The slave matrix KVM will be as a port expansion module of the master matrix KVM, the original remote console on slave KVM will be sacrificed and disabled.



CMC-8

- 8ft Matrix KVM cascade cable