

## CAT6 KVM

NetView:2U Rackmount 19" TFT 1280x1024 LCD KVM with 104 key notepad keyboard w/ Touchpad (e), Integrated with Matrix Cat6,16 KVM Ports + 2 User Via CAT5 Extender + 0 Users Via KVM over IP. Over Depth is 19 Inch. Dongles sold separately

Model: NVP2419MC0216e

## FEATURES:

- 2U dual slide 19" LCD console drawer
- 104-key keyboard with either touchpad or trackball
- Short depth design of 480mm(19 inch )Deep
- New enhanced aesthetics with molded front handle
- 2 post rack mounting available

## SPECIFICATIONS:

LCD Panel	
Diagonal size	19" TFT
Max. Resolution	1280 x 1024
Brightness (cd/m2)	250
Backlight	CCFL
Colors	16.7M
Contrast Ratio (typ)	1000 : 1
Viewing Angle (H/V)	160° x 160°
Active area (mm)	376 x 301
MTBF (hrs)	50,000
Casing Color	Black ( RAL 9005 )
Weight ( Single console)	
Net	20.5 kgs ( 45.1 lbs )
Gross	24.8 kgs ( 54.6 lbs )
Environmental	
Operating	0 to 50°C Degree
Storage	-5 to 60°C Degree
Relative humidity	5~90%, non-condensing
Shock	10G acceleration ( 11 ms duration )
Vibration	5~500Hz 1G RMS random vibration
Regulatory	FCC, CE
Power	
Input	Auto-sensing 100 to 240VAC, 50 / 60Hz
Consumption	Max. 48 Watt, Standby 5 Watt
<b>Product Dimensions ( Single console )</b>	
Product	441.6 x 480 x 88 mm / 17.4 x 18.1 x 3.5 inch
Packing	585 x 620 x 190 mm / 23 x 24.4 x 7.5 inch
<b>Product Dimensions ( with KVM )</b>	
Product	441.6 x 480 x 88 mm / 17.4 x 18.9 x 3.5 inch
Packing	585 x 620 x 190 mm / 23 x 24.4 x 7.5 inch



## DIMENSION

Front View



Rear View



Side View



Top View



UNIT : mm  
1mm = 0.03937 inch

## STANDARD KEYBOARD



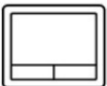
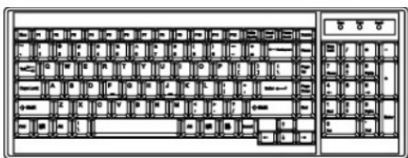













e keyboard integrated with touchpad



b keyboard integrated with trackball



### Supporting layouts

America	 United States				
EMEA	 United Kingdom	 Germany	 France	 Spain	 Norway
	 Italy	 Russia	 Switzerland	 Netherlands	 Portugal
Asia	 China	 Japan	 Korea	 Arabia	 Turkey

## STRUCTURE DIAGRAM



## KVM PORT & CAT6 DONGLE CONNECTION

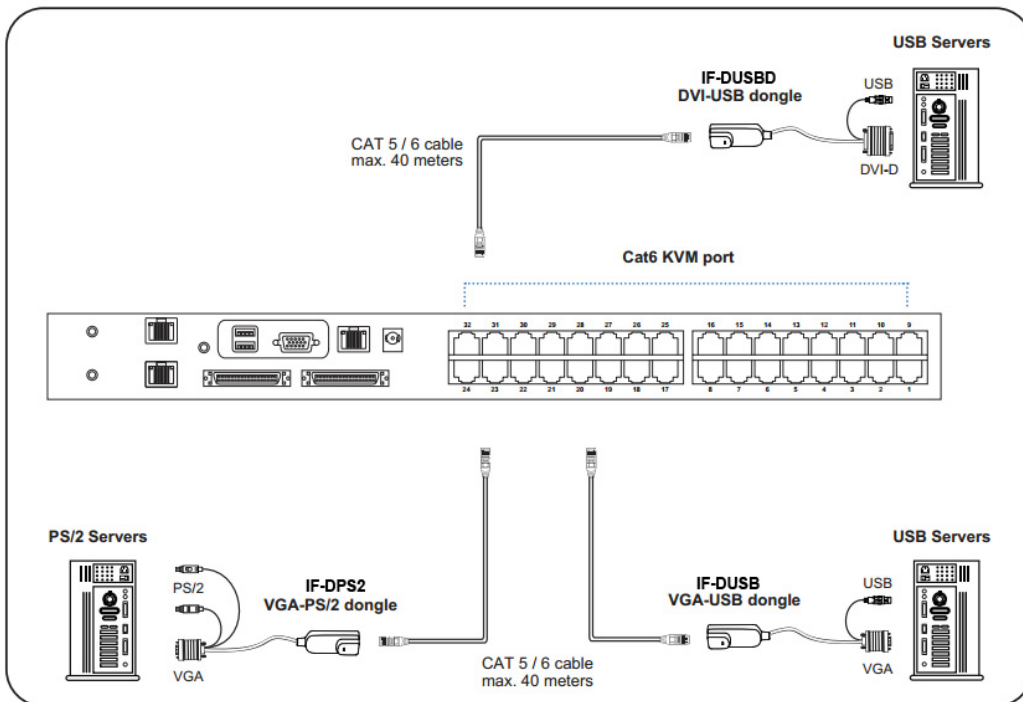

### IF-DUSBD DVI-USB dongle

- To connect DVI-D connector to the computer's video card
- To connect USB connector to the computer's USB port



### IF-DUSB VGA-USB dongle

- To connect DB-15 connector to the computer's video card
- To connect USB connector to the computer's USB port



### IF-DPS2 VGA-PS/2 dongle

- To connect DB-15 connector to the computer's video card
- To connect PS/2 keyboard connector to the computer's keyboard port
- To connect PS/2 mouse connector to the computer's mouse port

Cat6 Dongle	EDID Resolution Hard-coded	Resolutions Capable			
		4:3			16:10
		1024 x 768	1280 x 1024	1600 x 1200	1440 x 900
IF-DPS2	1600 x 1200	✓	✓	✓	✓*
IF-DUSB	1600 x 1200	✓	✓	✓	✓*
IF-DUSBD	1280 x 1024	✓	✓	✗	✗

\* Requires the user to enable showing unsupported resolutions via the target computer's video adapter settings (effectively ignoring the DDC / EDID)

### LOCAL CONSOLE & REMOTE CONSOLE CONNECTION



## Matrix Cat6 KVM Benefits

- Efficient system management with simultaneous multi-user access
- Capable of connecting 32 or 16 servers per device in 1U
- Support DVI-USB, VGA-USB & VGA-PS/2 server interface
- Increased distance of 40m between your server & KVM
- Enhanced Cat6 cable management with remote access up to 150m

## Switch Features & Options

- Provide a diversity of console to access servers independently and simultaneously
- Use of the RJ45 Cat6 interface allows for a higher number of ports in smaller density
- Greater distances between your switch and servers allow enhanced data center rack layouts
- Multi lingual on screen display menu
- Advanced user profiles and configurable OSD hot key combinations

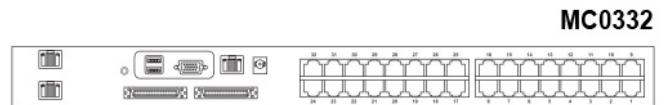
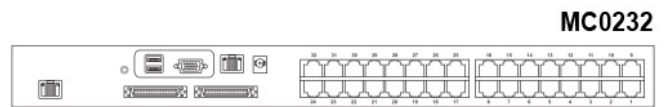

## KVM SPECIFICATIONS

<b>■ KVM Port</b>	
Number of ports:	16 or 32
Connector:	RJ-45
Connectivity:	DVI-D / VGA connector dongle up to 40 meters (132 feet) via Cat6 / Cat5 cable
<b>■ Local Console</b>	
Monitor port:	1 x DB15-pin VGA, up to 1600 x 1200
Keyboard & mouse port:	2 x USB type connector for keyboard & mouse
Resolution support:	4:3 - max. 1600x1200 16:10 - max. 1440x900
<b>■ Cat6 Remote Console</b>	
Number of remote port:	1 for MC0116 / MC0132 2 for MC0216 / MC0232 3 for MC0316 / MC0332
Monitor port:	DB15-pin VGA, up to 1600 x 1200
Keyboard & mouse port:	2 x USB type connector for keyboard & mouse
Remote I/O:	RJ45 via Cat5 / Cat5e / Cat6 cable up to 500 feet
Resolution support:	4:3 -max. 1600x1200 16:10-max. 1440x900
<b>■ Expansion:</b>	Up to 256 servers by 8-level cascade
<b>■ Compatibility</b>	
Multi-platform:	Mix PCs, SUN and Mac G3 / G4 Mac / iMac
Support:	Windows 7 / Vista / 2003 / XP, Linux, Unix

<b>■ Power</b>	
Input:	AC power adapter
Consumption:	Max. 48 Watt, Standby 5 Watt
<b>■ Regulatory :</b>	
Safety:	cUL, FCC & CE certified
Environment:	RoHS2 & REACH compliant
<b>■ Environmental</b>	
Operating:	0 to 50°C
Storage:	-5 to 60°C
Relative humidity:	90%, non-condensing
Shock:	50G peak acceleration (11ms, half-sine
Vibration:	58-100Hz / 0.98G (11ms / cycle)
<b>■ Product Information</b>	
Dimension (W x D x H):	443 x 171 x 44 mm / 17.4 x 6.7 x 1.73 inch
Net weight:	3 kg / 6.5 lb
<b>■ Packing Information</b>	
Dimension (W x D x H):	500 x400 x90 mm / 19.7 x 15.7x3.5 inch
Gross weight:	5 kg / 11 lb

## KVM CASCADE

- Cascade up to 8 levels, 256 servers
- Cascading multiple KVM with CMC-8 cascade cable



Cascaded KVMs from level 2 to 8 must be the models of MC0116 / MC0132 or M018 / M0116.



When multiple matrix KVMs cascade together, the master KVM at level 1 will take all control of other slave KVM switches (e.g. level 2 to 8).



The slave matrix KVM will be as a port expansion module of the master matrix KVM, the original remote console on slave KVM will be sacrificed and disabled.



### CMC-8

- 8ft Matrix KVM cascade cable