

1U 17.3" widescreen Full HD 1920 x 1080 LCD console drawer , with 104 key notepad keyboard w/ trackball (b), with 12-port DVI-D only+ USB+ Audio KVM switch, Audio out x 1, Includes NC-6: 6pc 6ft long DVI +USB+ Audio KVM Cables, 460mm (18 inch)Deep

Model: NW117HD-12Db



FEATURES:

- 1U 17.3" widescreen LCD console drawer
- Support Full HD with 1080p resolution
- 104-key keyboard with either touchpad or trackball
- New enhanced aesthetics with molded front handle
- Short depth design of 460mm(18 inch)Deep
- 12-port DVI-D, USB & Audio KVM
- DVI-D single link support 1920 x 1200 transmission
- Support widescreen & native SUN 1152 x 900 resolution
- Multi-platform for PCs, SUN and Mac G3 / G4 Mac / iMac
- Hot pluggable, no software or drivers required

SPECIFICATIONS:

LCD Panel	
Diagonal size	17.3" widescreen TFT
Max. Resolution	1920 x 1080
Brightness (cd/m2)	300
Backlight	LED
Colors	16.7M, 8-bit
Contrast Ratio (typ)	1000 : 1
Viewing Angle (H/V)	178° x 178°
Active area (mm)	382 x 215
MTBF (hrs)	15,000
Casing Color	Black (RAL 9005)
Weight (Single console	
Net	10.8 kgs (24 lbs)
Gross	15.8 kgs (34.8 lbs)
Environmental	
Operating	0 to 55°C Degree
Storage	-20 to 60°C Degree
Relative humidity	5~90%, non-condensing
Shock	10G acceleration (11 ms duration)
Vibration	10~300Hz 0.5G RMS random vibration
Regulatory	FCC, CE & CCC certified
Power	
Input	Auto-sensing 100 to 240VAC, 50 / 60Hz
Consumption	Max. 48 Watt, Standby 5 Watt
Product Dimensions (Single console)	
Product	441.6 x 584.2 x 44 mm / 17.4 x 23 x 1.73 inch
Packing	589.28 x 762 x 152.4 mm / 23.2 x 30 x 6 inch



STRUCTURE DIAGRAM

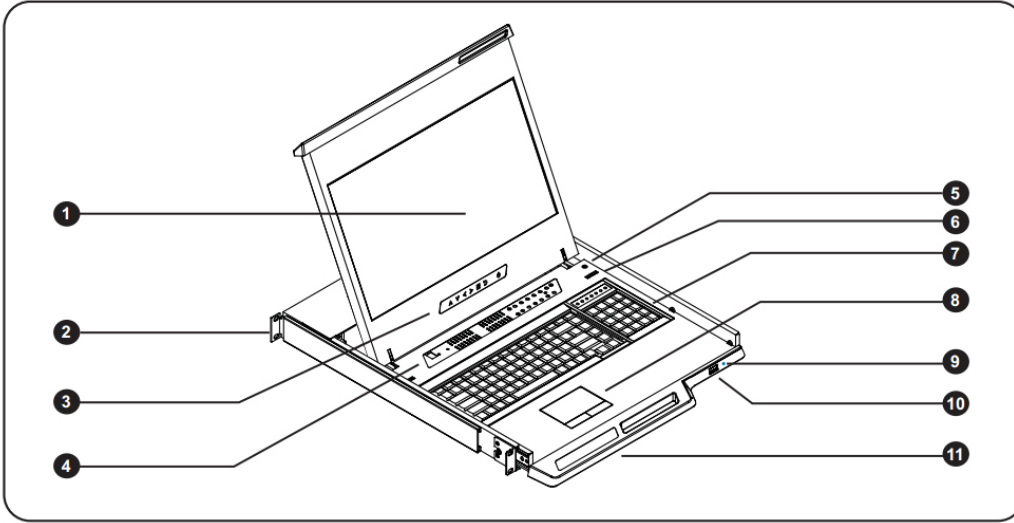





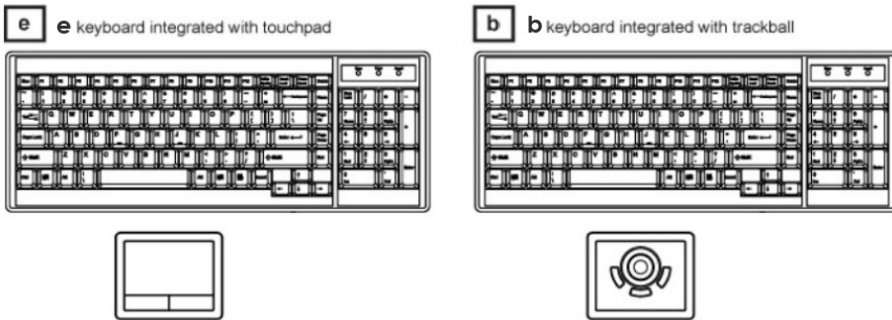











- ① LCD interchangeable module kit
- ② Installation Slides
- ③ LCD membrane 
- ④ Membrane switch (KVM option)
- ⑤ Micro switch for screen auto power off
- ⑥ Audio speaker (for SDI, HDMI or Audio option)
- ⑦ Keyboard interchangeable module kit
- ⑧ Mouse interchangeable module kit
- ⑨ Blue Power LED
- ⑩ Front USB port for device access (USB Hub KVM only)
- ⑪ Molded front handle

STANDARD KEYBOARD



Supporting layouts

America	 United States				
EMEA	 United Kingdom	 Germany	 France	 Spain	 Norway
Asia	 Italy	 Russia	 Switzerland	 Netherlands	 Portugal
	 China	 Japan	 Korea	 Arabia	 Turkey

KVM PORT CONNECTION

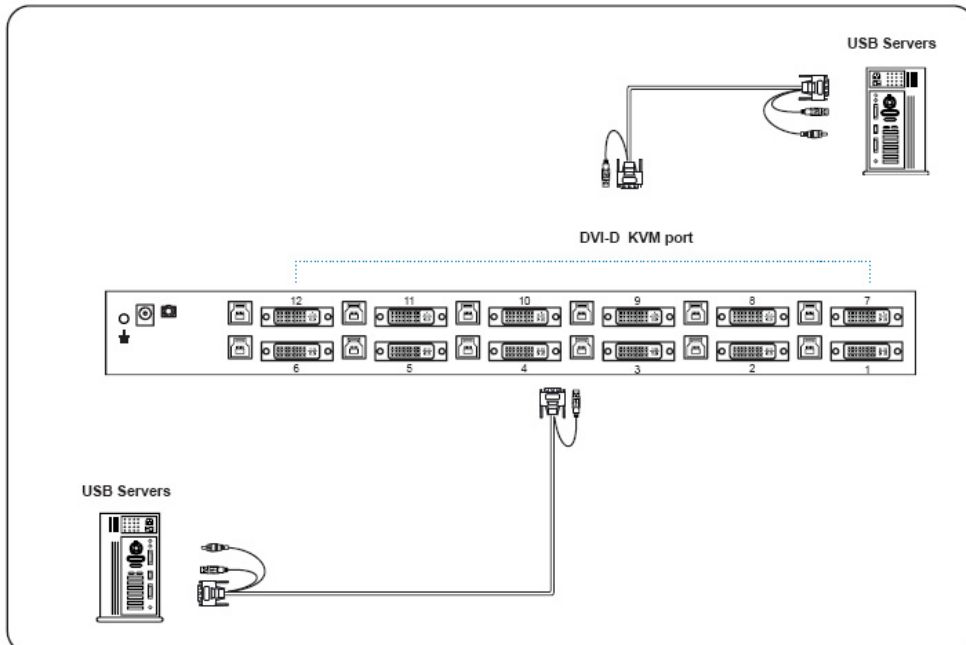

DVI KVM Cable

NC-6: 6 feet DVI KVM Cable

NC-15: 6 feet DVI KVM Cable

(Server end : DVI-D+USB+Audio)

(KVM Port: DVI-D+USB 3.0)



DVI KVM SPECIFICATIONS

KVM Port	
Number of ports:	12
Connector:	DVI-D connector
	USB 3.0 connector (combined for keyboard, mouse & audio)
Connectivity:	Combo 4-in-1 KVM cable, 6 or 15 feet
Local Console	
Graphic connector:	1 x DVI-D
Resolution:	Up to 1920x1200
Input device:	2 x USB type A for keyboard & mouse
Audio out:	1 x 3.5mm stereo audio
Management	
PC Selection:	Front button & keyboard hotkey
Compatibility	
Multi-platform:	Mix PCs, SUN and Mac G3 / G4 Mac / iMac
Support:	Windows 7 / Vista / 2003 / XP, Linux, Unix

Regulatory	
Safety:	FCC & CE certified
Environment:	RoHS2 & REACH compliant
Environmental	
Operating:	0 to 50°C
Storage:	-5 to 60°C
Relative humidity:	90%, non-condensing
Shock:	50G peak acceleration (11ms, half-sine wave)
Vibration:	58-100Hz/0.98G (11ms/ cycle)

Front Panel - Port LED Indications

DVI-D KVM 12 ports

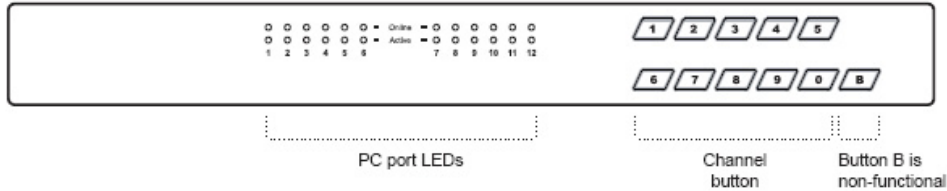

PC port LEDs	Online : Blue LED on indicating a PC is connecting to the port Active : Green LED on indicating a selected channel
Channel button	Press to select channel from 01 to 12