

# USB HUB KVM

NetView:1U 17.3" widescreen Full HD 1920 x 1080 LCD console drawer 16-ports USB RGB KVM switch (Includes 16 pcs 6ft long NB-6 Cables) and 2 x USB 2.0 port sharing USB peripheral for computers, with 104 key notepad Sun Compatible Keyboard w/ Trackball (b), 18 inch Deep

Model: NW117HD-BS16b



**FEATURES:**

- 1U 17.3" widescreen LCD console drawer
- Support Full HD with 1080p resolution
- 104-key notepad SUN Compatible keyboard with either touchpad or trackball
- New enhanced aesthetics with molded front handle
- Front USB port for device access ( USB Hub KVM only )
- Short depth design of 460mm (18 inch) Deep

**SPECIFICATIONS:**

LCD Panel	
Diagonal size	17.3" widescreen TFT
Max. Resolution	1920 x 1080
Brightness (cd/m2)	300
Backlight	LED
Colors	16.7M, 8-bit
Contrast Ratio (typ)	1000 : 1
Viewing Angle (H/V)	178° x 178°
Active area (mm)	382 x 215
MTBF (hrs)	15,000
Casing Color	Black ( RAL 9005 )
Weight ( Single console )	
Net	10.8 kgs ( 24 lbs )
Gross	15.8 kgs ( 34.8 lbs )
Environmental	
Operating	0 to 55°C Degree
Storage	-20 to 60°C Degree
Relative humidity	5-90%, non-condensing
Shock	10G acceleration ( 11 ms duration )
Vibration	10-300Hz 0.5G RMS random vibration
Regulatory	FCC, CE & CCC certified
Power	
Input	Auto-sensing 100 to 240VAC, 50 / 60Hz
Consumption	Max. 48 Watt, Standby 5 Watt
Product Dimensions ( Single console )	
Product	441.6 x 584.2 x 44 mm / 17.4 x 23 x 1.73 inch
Packing	589.28 x 762 x 152.4 mm / 23.2 x 30 x 6 inch



## SUN Keyboard / Mouse Options

**Se**

SUN keyboard integrated with touchpad

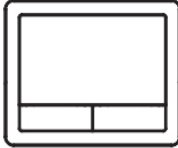
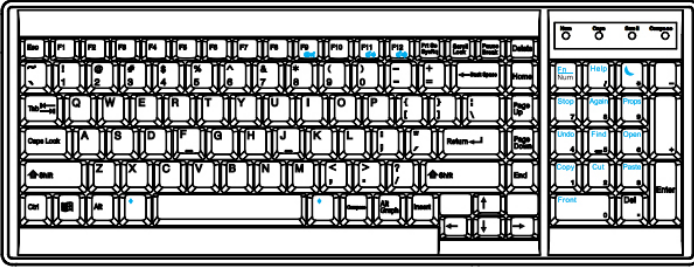

**Sb**

SUN keyboard integrated with trackball

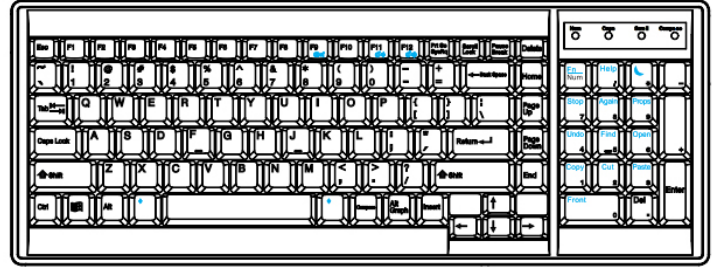

### SUN keyboard integrated with touchpad/trackball

- Incorporates SUN keys, including Stop, Cut, Paste, Compose, Copy and Help
- 104 key notepad keyboard with full numerical pad and SUN function
- USB interface
- US layout only

### How to Use "SUN" Keyboard

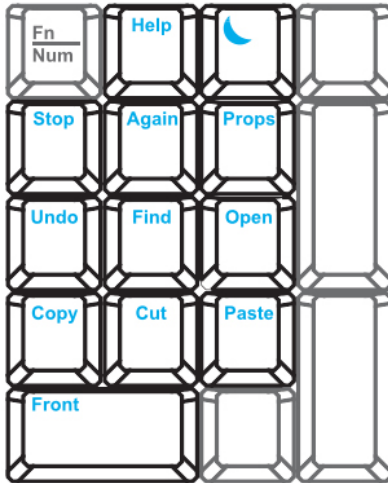

#### Num LED in Off mode

Key pad behaves as a SUN Solar system administration command mode

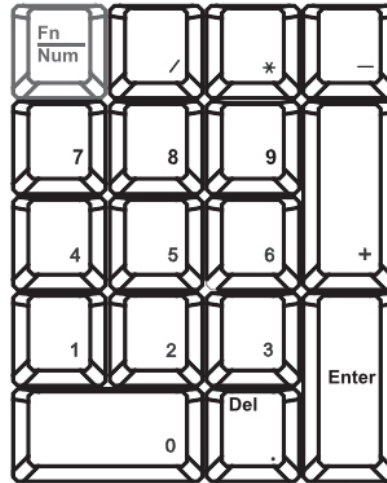

#### Num LED in Green mode

Key pad behaves as a normal key pad mode

### Audio / Display Keys

\* Please ask your supplier for full details



**F9**  
Audio : Mute  
Display : Degauss



**F11**  
Audio : Decrease volume  
Display : Decrease contrast



**F12**  
Audio : Increase volume  
Display : Increase contrast

## STRUCTURE DIAGRAM

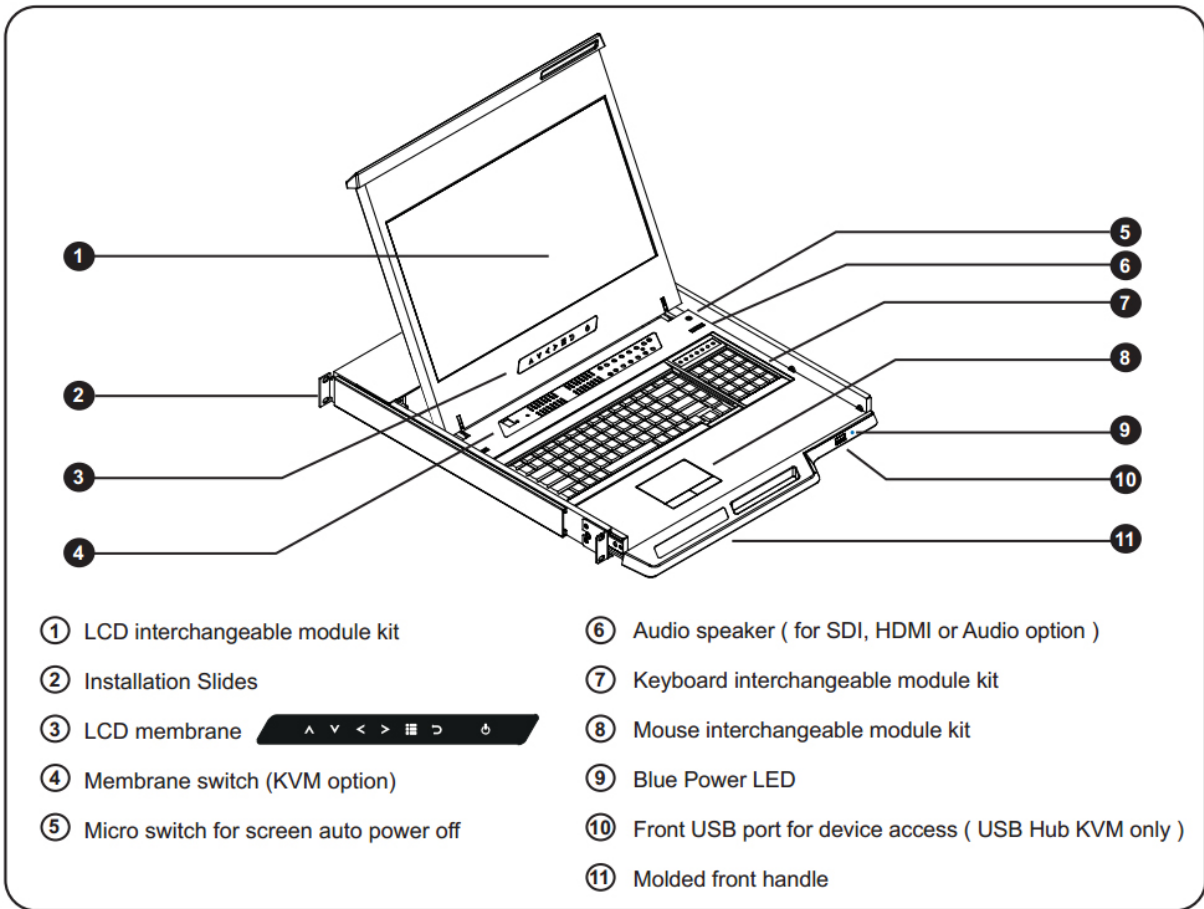

## BUILT-IN USB HUB USAGE & CONNECTION

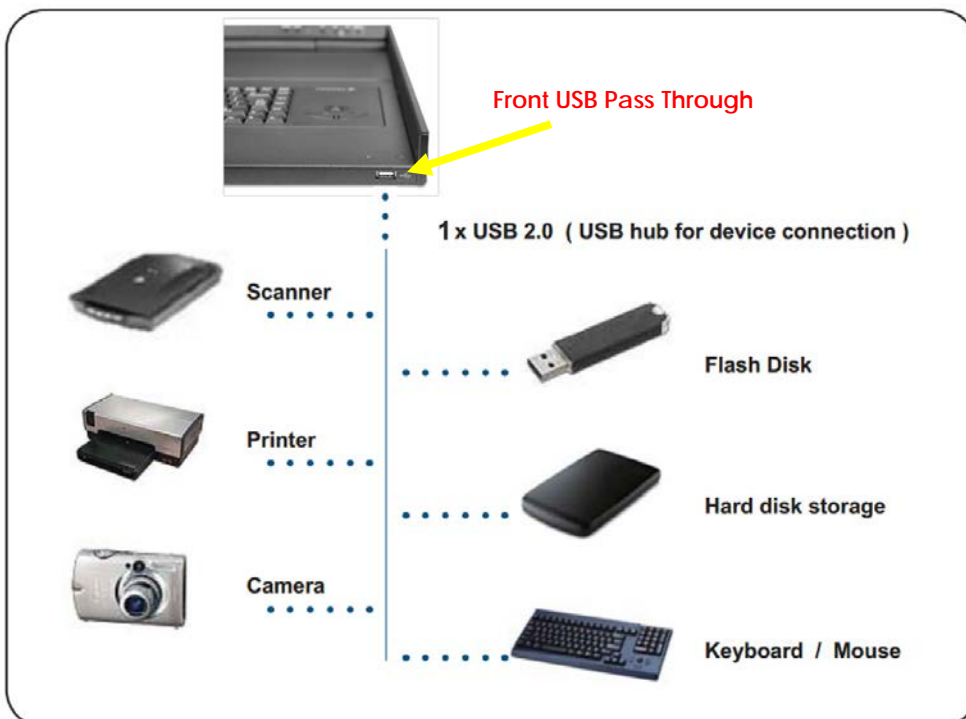

## USB Hub DB-15 KVM Benefits

- VGA-USB DB-15 KVM with either 8 or 16 ports in 1U
- 2 x USB 2.0 port sharing USB peripheral for computers
- Mix USB & SUN with Multi-Platform switch capability
- Support resolution up to 1920 x 1080
- SUN 1152 x 900 resolution compatible
- Hot pluggable, no software or drivers required
- Easy & quick installation

## Switch Features & Options

- Multi lingual on screen display menu
- Advanced user profiles and configurable OSD hot key combinations
- 12V, 24V and 48V DC Power options

**Note: No Daisy chain function on USB Hub KVM model**

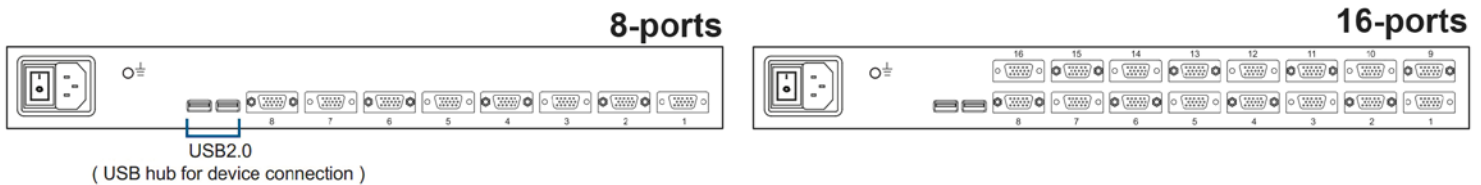

## Real View



## KVM SPECIFICATIONS

<b>■ KVM Port</b>	
Number of ports:	8 or 16
Connector:	DB-15 combo connector
Connectivity:	Combo 2-in-1 VGA + USB KVM cable, 6, 10 or 15 feet
<b>■ Local Console</b>	
Graphic Connector:	1 x DB-15
Resolution:	Up to 1920 x 1200
Input device:	2 x USB type A for keyboard & mouse
USB hub:	2 x USB type A for sharing other peripheral devices among the computers
<b>■ Management</b>	
Multilingual OSD:	English, France, German, Spanish, Italian, Russian, Simplified Chinese, Japanese
Hotkey Combination:	Scroll-lock, Cap-lock, Num-lock, Alt, Ctrl & Win
Security:	Password enable & Disable, up to 8 users profile for port access
PC Selection:	Front button, OSD menu & Hotkey
<b>■ Compatibility</b>	
Multi-platform:	Mix PCs, SUN and Mac G3 / G4 Mac / iMac
Support:	Windows 7 / Vista / 2003 / XP, Linux, Unix

<b>■ Power</b>	
Input:	Auto sensing 100 to 240VAC, 50 / 60 Hz
Option DC:	12V / 24V / 48V DC input
Consumption:	Max. 12 Watt, Standby 5 Watt
<b>■ Regulatory :</b>	
Safety:	FCC & CE certified
Environment:	RoHS2 & REACH compliant
<b>■ Environmental</b>	
Operating:	0 to 50°C
Storage:	-5 to 60°C
Relative humidity:	90%, non-condensing
Shock:	50G peak acceleration (11ms, half-sine wave)
Vibration:	58-100Hz / 0.98G (11ms / cycle)
<b>■ Product Information</b>	
Dimension (W x D x H):	443 x 171 x 44 mm / 17.4 x 6.7 x 1.73 inch
Net weight:	3 kg / 6.5 lb
<b>■ Packing Information</b>	
Dimension (W x D x H):	500 x 400 x 90 mm / 19.7 x 15.7 x 3.5 inch
Gross weight:	5 kg / 11 lb

## KVM PORT CONNECTION

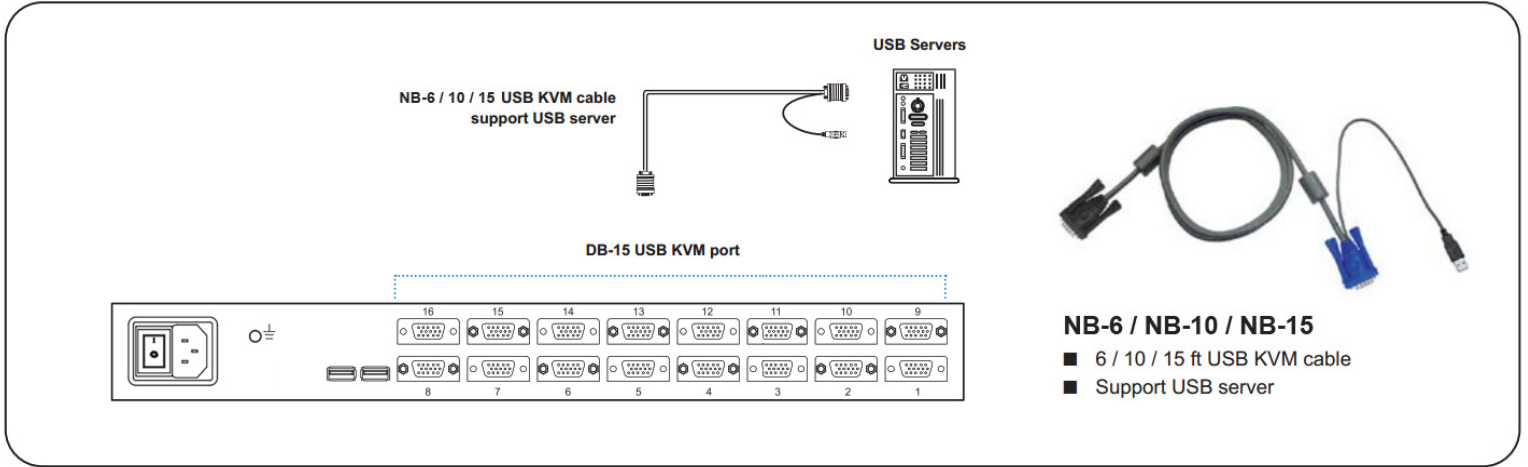

## Front Panel - Port LED Indications

