

# USB HUB KVM

NetView:1U 17.3" widescreen Full HD 1920 x 1080 LCD console drawer Over IP remote 16-ports USB RGB KVM switch (Includes 16 pcs 6ft long NB-6 Cables) and 2 x USB 2.0 port sharing USB peripheral for computers, with 104 key notepad keyboard w/ Touchpad (e), 18 inch Deep

Model: NW117HD-IPB16e



### FEATURES:

- 1U 17.3" widescreen LCD console drawer
- Support Full HD with 1080p resolution
- 104-key keyboard with either touchpad or trackball
- New enhanced aesthetics with molded front handle
- Front USB port for device access ( USB Hub KVM only )
- Short depth design of 460mm (18 inch) Deep

### SPECIFICATIONS:

LCD Panel	
Diagonal size	17.3" widescreen TFT
Max. Resolution	1920 x 1080
Brightness (cd/m2)	300
Backlight	LED
Colors	16.7M, 8-bit
Contrast Ratio (typ)	1000 : 1
Viewing Angle (H/V)	178° x 178°
Active area (mm)	382 x 215
MTBF (hrs)	15,000
Casing Color	Black ( RAL 9005 )
Weight ( Single console )	
Net	10.8 kgs ( 24 lbs )
Gross	15.8 kgs ( 34.8 lbs )
Environmental	
Operating	0 to 55°C Degree
Storage	-20 to 60°C Degree
Relative humidity	5-90%, non-condensing
Shock	10G acceleration ( 11 ms duration )
Vibration	10-300Hz 0.5G RMS random vibration
Regulatory	FCC, CE & CCC certified
Power	
Input	Auto-sensing 100 to 240VAC, 50 / 60Hz
Consumption	Max. 48 Watt, Standby 5 Watt
Product Dimensions ( Single console )	
Product	441.6 x 584.2 x 44 mm / 17.4 x 23 x 1.73 inch
Packing	589.28 x 762 x 152.4 mm / 23.2 x 30 x 6 inch



## STRUCTURE DIAGRAM

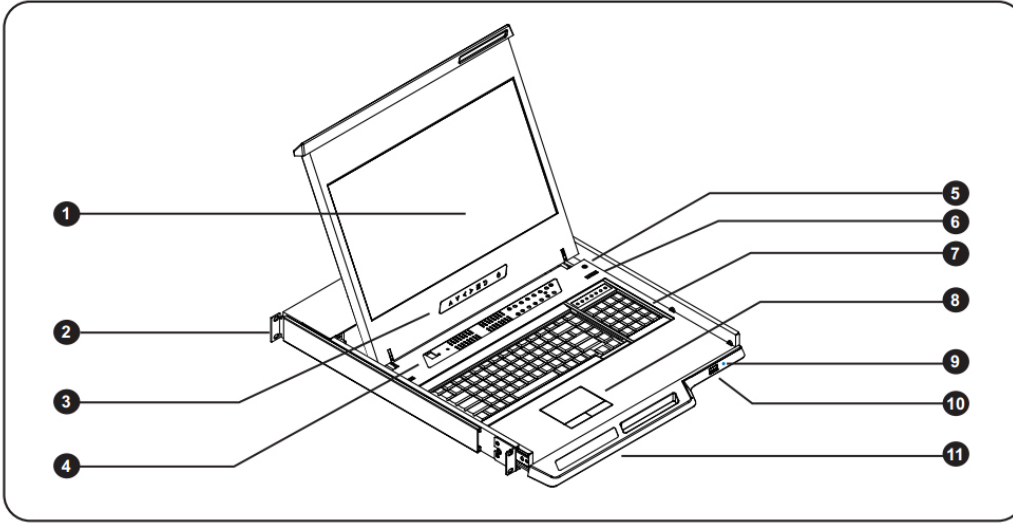





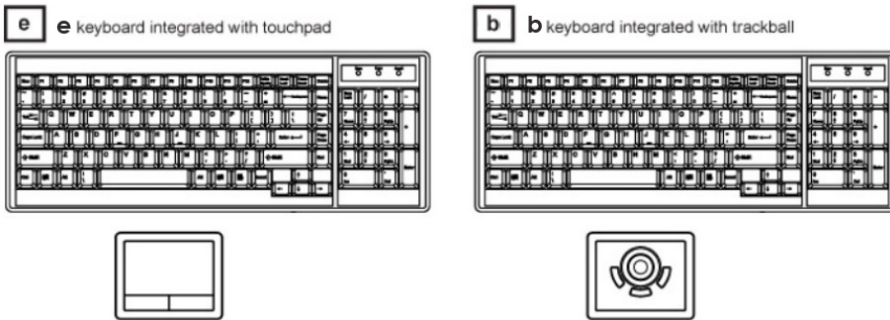











- ① LCD interchangeable module kit
- ② Installation Slides
- ③ LCD membrane 
- ④ Membrane switch (KVM option)
- ⑤ Micro switch for screen auto power off
- ⑥ Audio speaker ( for SDI, HDMI or Audio option )
- ⑦ Keyboard interchangeable module kit
- ⑧ Mouse interchangeable module kit
- ⑨ Blue Power LED
- ⑩ Front USB port for device access ( USB Hub KVM only )
- ⑪ Molded front handle

## STANDARD KEYBOARD



### Supporting layouts

<b>America</b>	 United States				
<b>EMEA</b>	 United Kingdom	 Germany	 France	 Spain	 Norway
	 Italy	 Russia	 Switzerland	 Netherlands	 Portugal
<b>Asia</b>	 China	 Japan	 Korea	 Arabia	 Turkey

## BUILT-IN USB HUB USAGE & CONNECTION

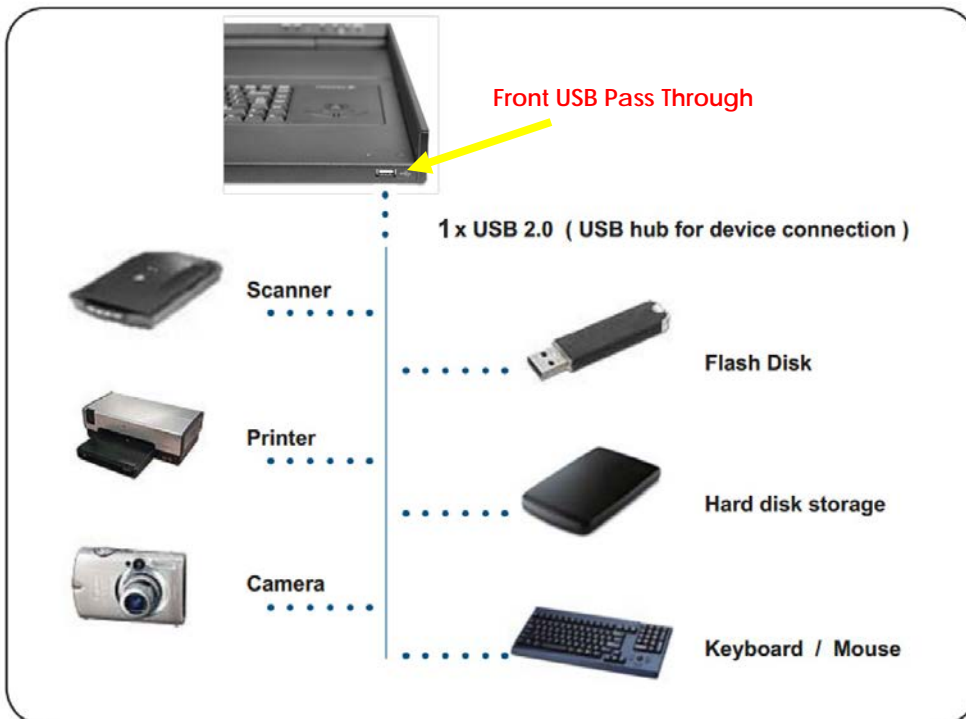

## USB Hub DB-15 IP KVM Benefits

- VGA-USB DB-15 KVM with either 8 or 16 ports in 1U
- IP remote access across the world wide web
- 2 x USB 2.0 port sharing USB peripheral for computers
- Mix USB & SUN with Multi-Platform switch capability
- Support resolution up to 1920 x 1080
- SUN 1152 x 900 resolution compatible
- Hot pluggable, no software or drivers required
- Easy & quick installation

## Switch Features & Options

- Multi lingual on screen display menu
- Control hardware and software systems from a remote location without physically being at the server's location
- Advanced user profiles and configurable OSD hot key combinations
- 12V, 24V and 48V DC Power options

**Note: No Daisy chain function on USB Hub KVM model**

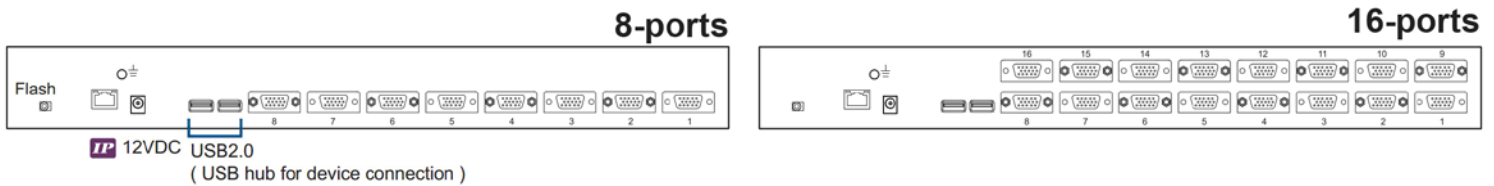

## Real View



## KVM SPECIFICATIONS

<b>■ KVM Port</b>		<b>■ Power</b>	
Number of ports:	8 or 16	Input:	Auto sensing 100 to 240VAC, 50 / 60 Hz
Connector:	DB-15 combo connector	Option DC:	12V / 24V / 48V DC input
Connectivity:	Combo 2-in-1 VGA + USB KVM cable, 6, 10 or 15 feet	Consumption:	Max. 12 Watt, Standby 5 Watt
<b>■ Local Console</b>		<b>■ Regulatory :</b>	
Graphic connector:	1 x DB-15	Safety:	FCC & CE certified
Resolution:	Up to 1920x1200	Environment:	RoHS2 & REACH compliant
Input device:	2 x USB type A for keyboard & mouse	<b>■ Environmental</b>	
USB hub:	2 x USB type A for sharing other peripheral devices among the computers	Operating:	0 to 50°C
<b>■ IP Remote Console</b>		Storage:	-5 to 60°C
Connector:	RJ45 Ethernet	Relative humidity:	90%, non-condensing
User management:	15-user login, 1 x active user	Shock:	50G peak acceleration (11ms, half-sine wave)
Network protocol:	DHCP / BOOTP / DNS	Vibration:	58-100Hz / 0.98G (11ms / cycle)
Security:	SSL v3, RSA, AES, HTTP / HTTPS, CSR	<b>■ Product Information</b>	
Resolution:	Up to 1600 x 1200	Dimension (W x D x H):	443 x 171 x 44 mm / 17.4 x 6.7 x 1.73 inch
Browser:	IE, Firefox, Safari, Netscape	Net weight:	3 kg / 6.5 lb
<b>■ Compatibility</b>		<b>■ Packing Information</b>	
Multi-platform:	Mix PCs, SUN and Mac G3 / G4 Mac / iMac	Dimension (W x D x H):	500 x 400 x 90 mm / 19.7 x 15.7 x 3.5 inch
Support:	Windows 7 / Vista / 2003 / XP, Linux, Unix	Gross weight:	5 kg / 11 lb

## KVM PORT CONNECTION



## IP & Local console connection

