

# USB HUB KVM

NetView:1U 17.3" widescreen Full HD 1920 x 1080 LCD console drawer Over IP remote 8-ports USB RGB KVM switch (Includes 8 pcs 6ft long NB-6 Cables) and 2 x USB 2.0 port sharing USB peripheral for computers, with 104 key notepad MAC keyboard w/ Touchpad (e), 18 inch Deep

Model: NW117HD-IPBM8e



**FEATURES:**

- 1U 17.3" widescreen LCD console drawer
- Support Full HD with 1080p resolution
- 104-key notepad MAC keyboard with either touchpad or trackball
- New enhanced aesthetics with molded front handle
- Front USB port for device access ( USB Hub KVM only )
- Short depth design of 580mm ( 23 inch ) Deep

**SPECIFICATIONS:**

|                                       |   |
|---------------------------------------|---|
| LCD Panel                             |   |
| Diagonal size                         | 17.3" widescreen TFT                          |
| Max. Resolution                       | 1920 x 1080                                   |
| Brightness (cd/m2)                    | 300   |
| Backlight                             | LED   |
| Colors                                | 16.7M, 8-bit                                  |
| Contrast Ratio (typ)                  | 1000 : 1                                      |
| Viewing Angle (H/V)                   | 178° x 178°                                   |
| Active area (mm)                      | 382 x 215                                     |
| MTBF (hrs)                            | 15,000  |
| Casing Color                          | Black ( RAL 9005 )                            |
| Weight ( Single console )             |   |
| Net                                   | 10.8 kgs ( 24 lbs )                           |
| Gross                                 | 15.8 kgs ( 34.8 lbs )                         |
| Environmental                         |   |
| Operating                             | 0 to 55°C Degree                              |
| Storage                               | -20 to 60°C Degree                            |
| Relative humidity                     | 5-90%, non-condensing                         |
| Shock                                 | 10G acceleration ( 11 ms duration )           |
| Vibration                             | 10-300Hz 0.5G RMS random vibration            |
| Regulatory                            | FCC, CE & CCC certified                       |
| Power                                 |   |
| Input                                 | Auto-sensing 100 to 240VAC, 50 / 60Hz         |
| Consumption                           | Max. 48 Watt, Standby 5 Watt                  |
| Product Dimensions ( Single console ) |   |
| Product                               | 441.6 x 584.2 x 44 mm / 17.4 x 23 x 1.73 inch |
| Packing                               | 589.28 x 762 x 152.4 mm / 23.2 x 30 x 6 inch  |



## MAC Keyboard / Mouse Options

**Me** MAC keyboard integrated with touchpad

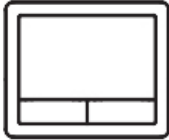

**Mb** MAC keyboard integrated with trackball



### Supporting layouts

America



United States

## How to Use "MAC" Keyboard

### Keyboard Features



**F1**  
Decrease display brightness



**F9**  
Fast-forward

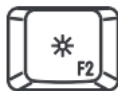

**F2**  
Increase display brightness



**F10**  
Mute sound



**F3**  
Mission control  
\* Only works with OS X Lion  
default Keyboard Shortcuts.



**F11**  
Decrease volume



**F4**  
Dashboard



**F12**  
Increase volume



**F7**  
Rewind



**Eject disc**

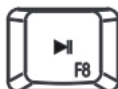

**F8**  
Play / Pause



**Command**

## STRUCTURE DIAGRAM

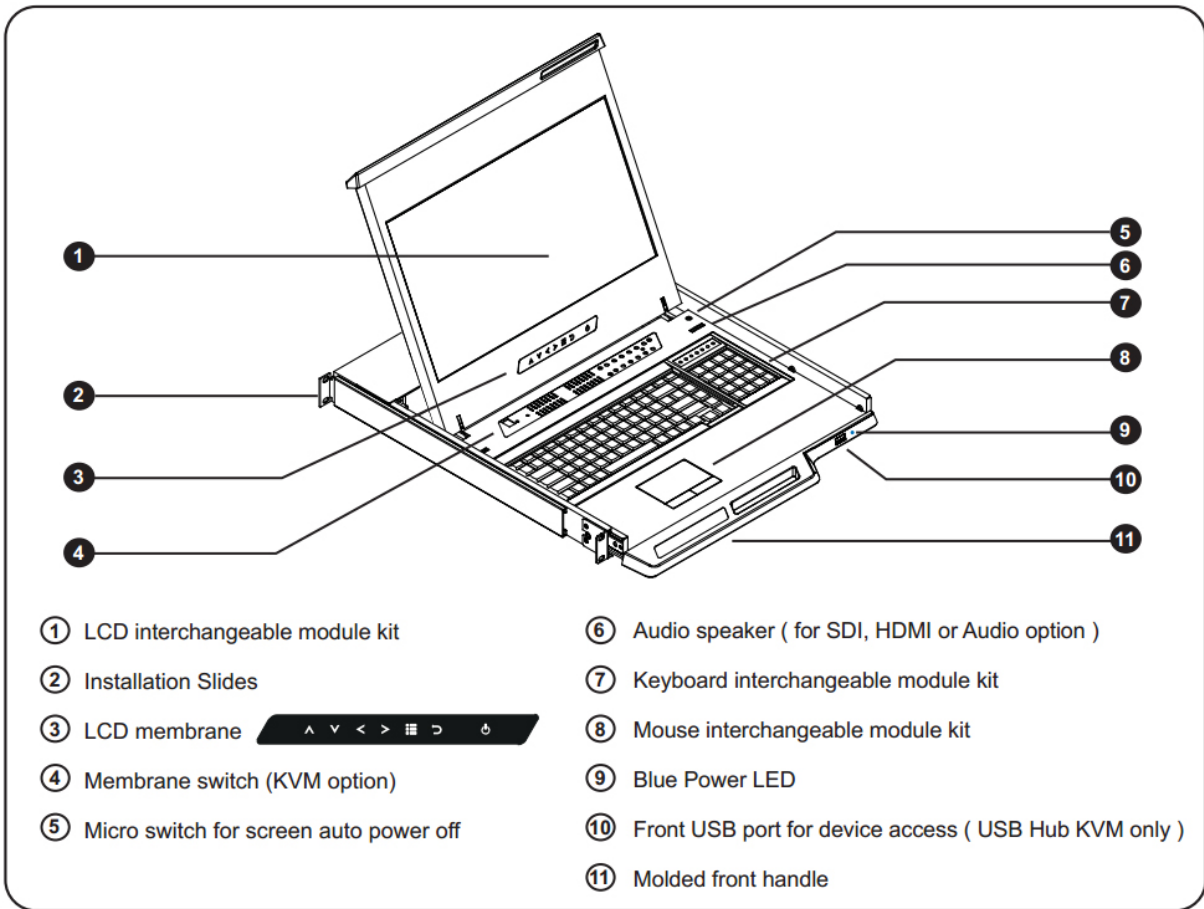

## BUILT-IN USB HUB USAGE & CONNECTION

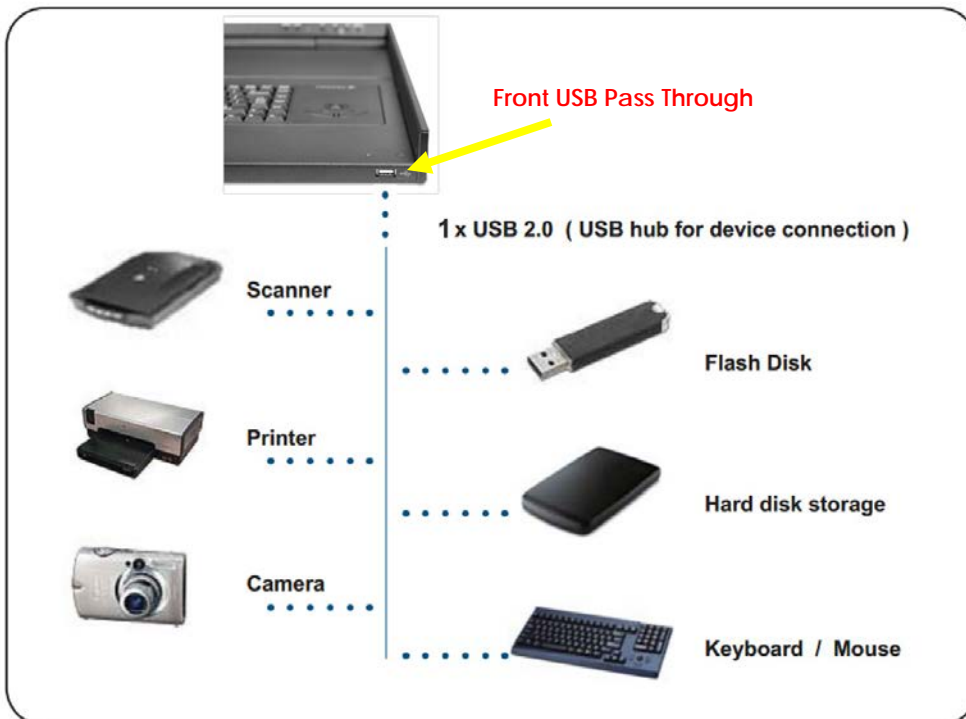

## USB Hub DB-15 IP KVM Benefits

- VGA-USB DB-15 KVM with either 8 or 16 ports in 1U
- IP remote access across the world wide web
- 2 x USB 2.0 port sharing USB peripheral for computers
- Mix USB & SUN with Multi-Platform switch capability
- Support resolution up to 1920 x 1080
- SUN 1152 x 900 resolution compatible
- Hot pluggable, no software or drivers required
- Easy & quick installation

## Switch Features & Options

- Multi lingual on screen display menu
- Control hardware and software systems from a remote location without physically being at the server's location
- Advanced user profiles and configurable OSD hot key combinations
- 12V, 24V and 48V DC Power options

**Note: No Daisy chain function on USB Hub KVM model**

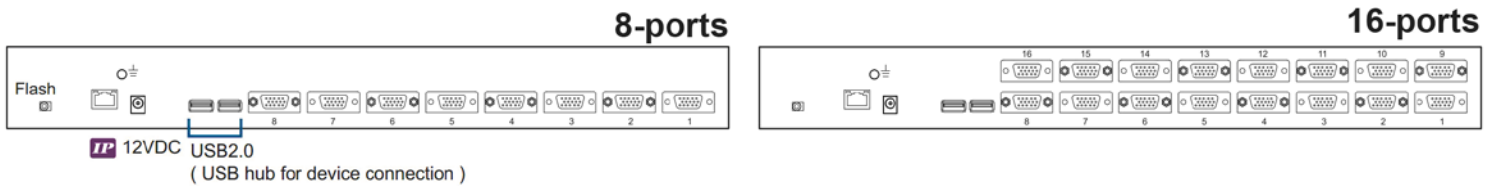

## Real View



## KVM SPECIFICATIONS

|                            |   |
|----------------------------|---|
| <b>■ KVM Port</b>          |   |
| Number of ports:           | 8 or 16   |
| Connector:                 | DB-15 combo connector   |
| Connectivity:              | Combo 2-in-1 VGA + USB KVM cable, 6, 10 or 15 feet                      |
| <b>■ Local Console</b>     |   |
| Graphic connector:         | 1 x DB-15   |
| Resolution:                | Up to 1920x1200   |
| Input device:              | 2 x USB type A for keyboard & mouse                                     |
| USB hub:                   | 2 x USB type A for sharing other peripheral devices among the computers |
| <b>■ IP Remote Console</b> |   |
| Connector:                 | RJ45 Ethernet   |
| User management:           | 15-user login, 1 x active user  |
| Network protocol:          | DHCP / BOOTP / DNS  |
| Security:                  | SSL v3, RSA, AES, HTTP / HTTPS, CSR                                     |
| Resolution:                | Up to 1600 x 1200   |
| Browser:                   | IE, Firefox, Safari, Netscape   |
| <b>■ Compatibility</b>     |   |
| Multi-platform:            | Mix PCs, SUN and Mac G3 / G4 Mac / iMac                                 |
| Support:                   | Windows 7 / Vista / 2003 / XP, Linux, Unix                              |

|                              |  |
|------------------------------|--|
| <b>■ Power</b>               |  |
| Input:                       | Auto sensing 100 to 240VAC, 50 / 60 Hz       |
| Option DC:                   | 12V / 24V / 48V DC input                     |
| Consumption:                 | Max. 12 Watt, Standby 5 Watt                 |
| <b>■ Regulatory :</b>        |  |
| Safety:                      | FCC & CE certified                           |
| Environment:                 | RoHS2 & REACH compliant                      |
| <b>■ Environmental</b>       |  |
| Operating:                   | 0 to 50°C                                    |
| Storage:                     | -5 to 60°C                                   |
| Relative humidity:           | 90%, non-condensing                          |
| Shock:                       | 50G peak acceleration (11ms, half-sine wave) |
| Vibration:                   | 58-100Hz / 0.98G (11ms / cycle)              |
| <b>■ Product Information</b> |  |
| Dimension (W x D x H):       | 443 x 171 x 44 mm / 17.4 x 6.7 x 1.73 inch   |
| Net weight:                  | 3 kg / 6.5 lb                                |
| <b>■ Packing Information</b> |  |
| Dimension (W x D x H):       | 500 x 400 x 90 mm / 19.7 x 15.7 x 3.5 inch   |
| Gross weight:                | 5 kg / 11 lb                                 |

## KVM PORT CONNECTION

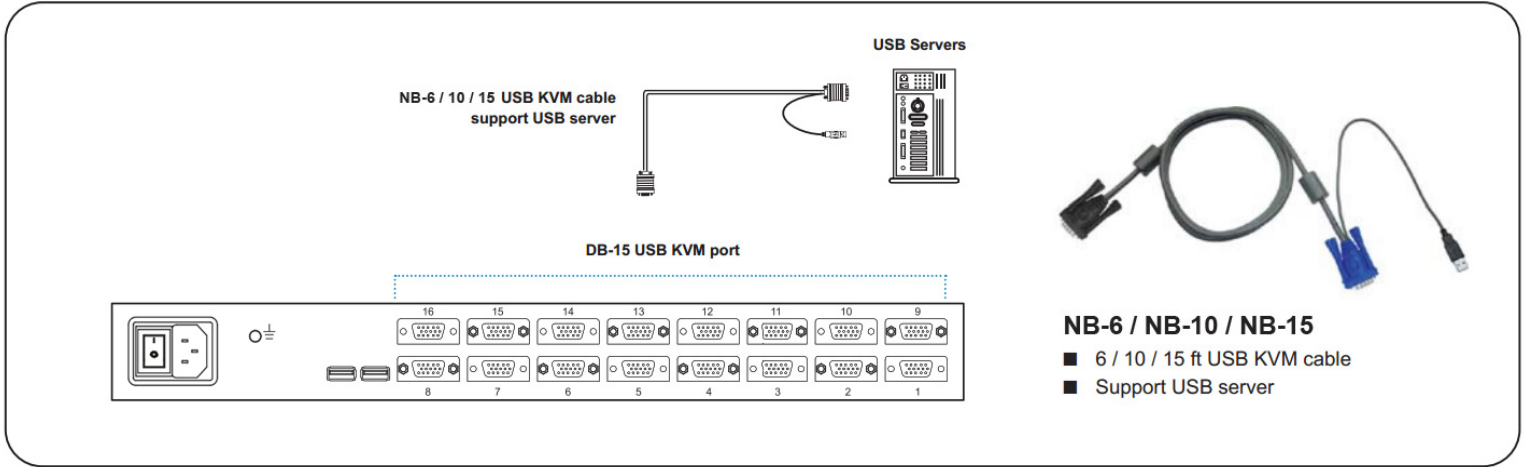

## IP & Local console connection

