

USB HUB KVM

NetView:1U 17.3" widescreen Full HD 1920 x 1080 LCD console drawer Over IP remote 16-ports USB RGB KVM switch (Includes 16 pcs 6ft long NB-6 Cables) and 2 x USB 2.0 port sharing USB peripheral for computers, with 104 key notepad Sun Compatible Keyboard w/ Trackball (b), 18 inch Deep

Model: NW117HD-IPBS16b



FEATURES:

- 1U 17.3" widescreen LCD console drawer
- Support Full HD with 1080p resolution
- 104-key notepad SUN Compatible keyboard with either touchpad or trackball
- New enhanced aesthetics with molded front handle
- Front USB port for device access (USB Hub KVM only)
- Short depth design of 460mm (18 inch) Deep

SPECIFICATIONS:

LCD Panel	
Diagonal size	17.3" widescreen TFT
Max. Resolution	1920 x 1080
Brightness (cd/m2)	300
Backlight	LED
Colors	16.7M, 8-bit
Contrast Ratio (typ)	1000 : 1
Viewing Angle (H/V)	178° x 178°
Active area (mm)	382 x 215
MTBF (hrs)	15,000
Casing Color	Black (RAL 9005)
Weight (Single console)	
Net	10.8 kgs (24 lbs)
Gross	15.8 kgs (34.8 lbs)
Environmental	
Operating	0 to 55°C Degree
Storage	-20 to 60°C Degree
Relative humidity	5-90%, non-condensing
Shock	10G acceleration (11 ms duration)
Vibration	10-300Hz 0.5G RMS random vibration
Regulatory	FCC, CE & CCC certified
Power	
Input	Auto-sensing 100 to 240VAC, 50 / 60Hz
Consumption	Max. 48 Watt, Standby 5 Watt
Product Dimensions (Single console)	
Product	441.6 x 584.2 x 44 mm / 17.4 x 23 x 1.73 inch
Packing	589.28 x 762 x 152.4 mm / 23.2 x 30 x 6 inch



SUN Keyboard / Mouse Options

Se

SUN keyboard integrated with touchpad

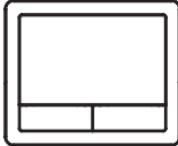
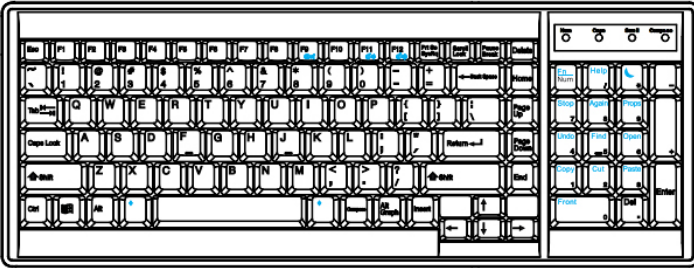

Sb

SUN keyboard integrated with trackball

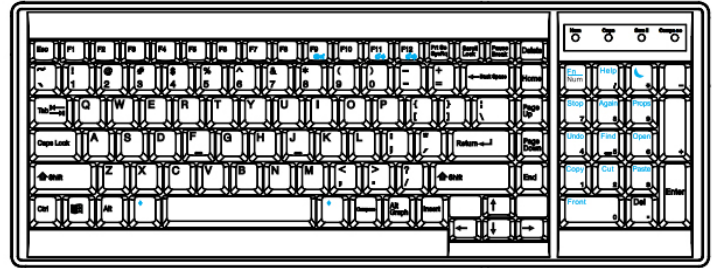

SUN keyboard integrated with touchpad/trackball

- Incorporates SUN keys, including Stop, Cut, Paste, Compose, Copy and Help
- 104 key notepad keyboard with full numerical pad and SUN function
- USB interface
- US layout only

How to Use "SUN" Keyboard

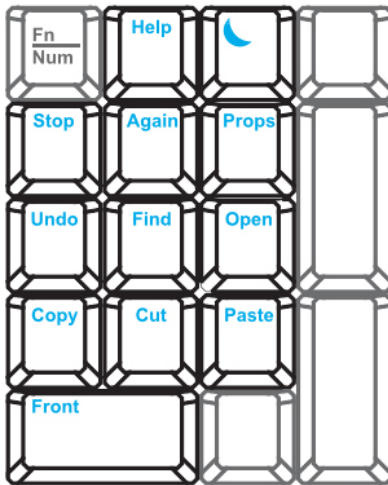

Num LED in Off mode

Key pad behaves as a SUN Solar system administration command mode

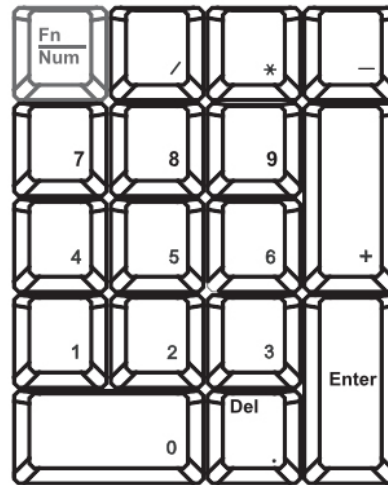

Num LED in Green mode

Key pad behaves as a normal key pad mode

Audio / Display Keys

* Please ask your supplier for full details

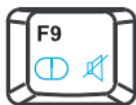

F9
Audio : Mute
Display : Degauss



F11
Audio : Decrease volume
Display : Decrease contrast

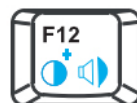

F12
Audio : Increase volume
Display : Increase contrast

STRUCTURE DIAGRAM

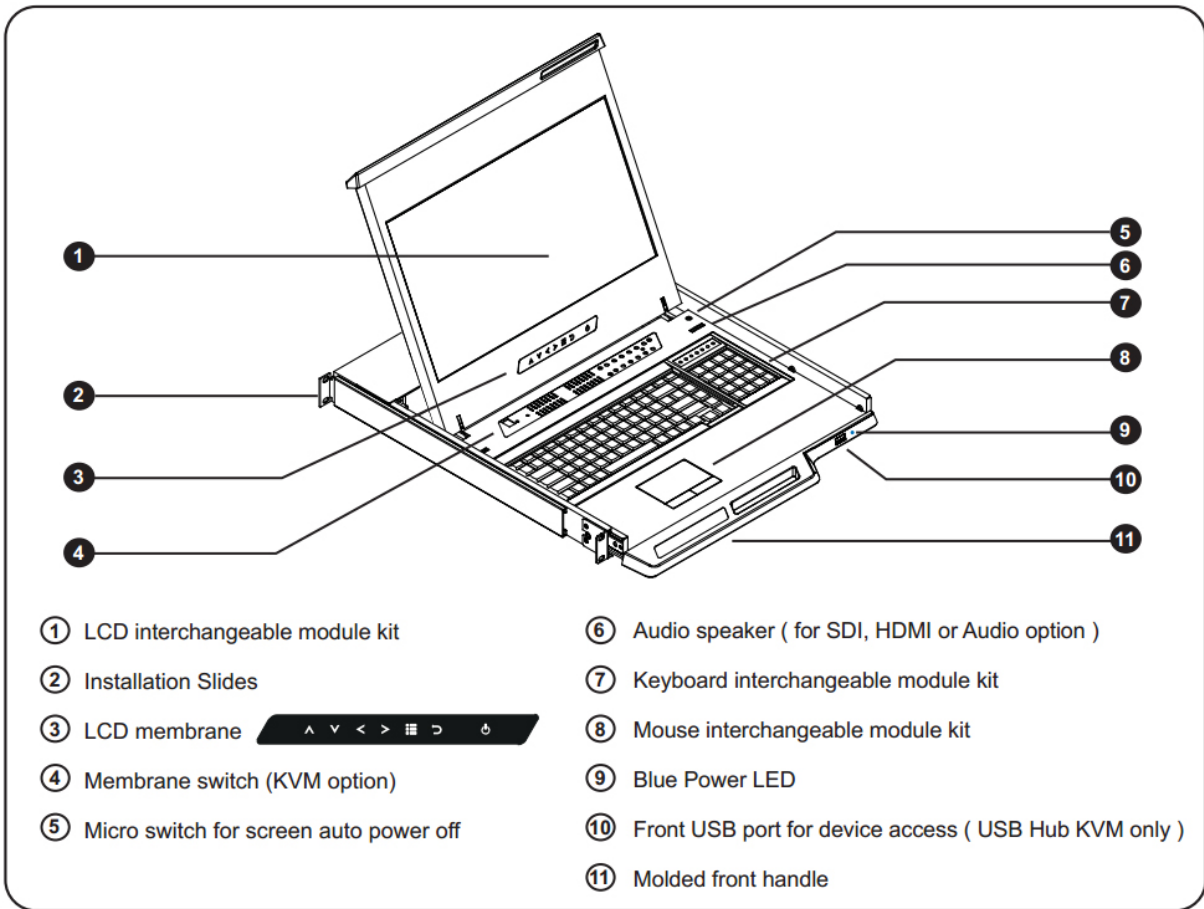

BUILT-IN USB HUB USAGE & CONNECTION

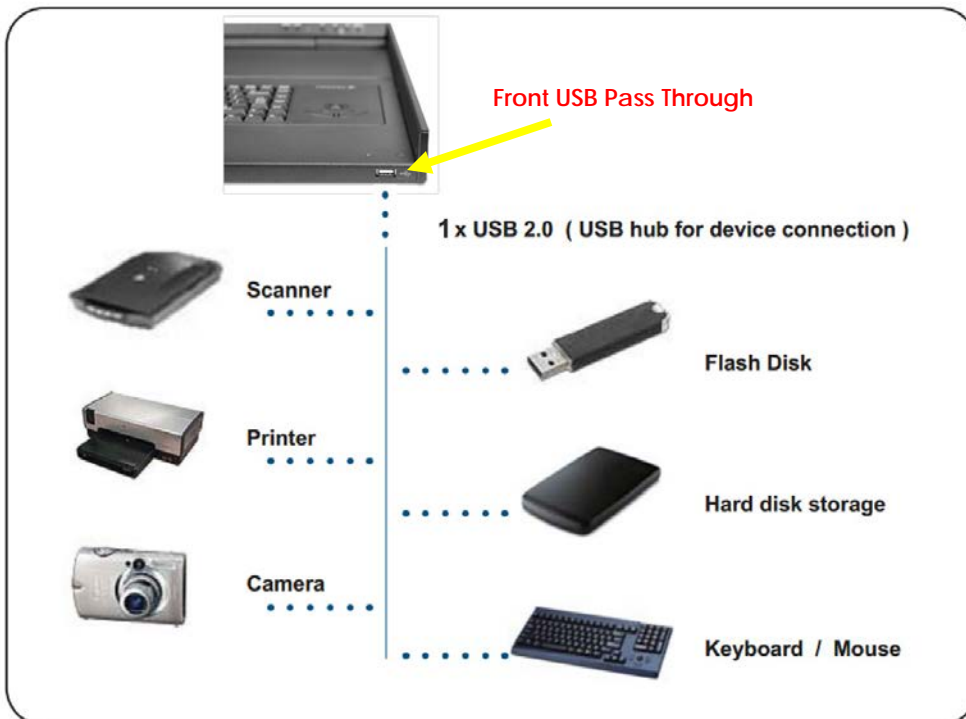

USB Hub DB-15 IP KVM Benefits

- VGA-USB DB-15 KVM with either 8 or 16 ports in 1U
- IP remote access across the world wide web
- 2 x USB 2.0 port sharing USB peripheral for computers
- Mix USB & SUN with Multi-Platform switch capability
- Support resolution up to 1920 x 1080
- SUN 1152 x 900 resolution compatible
- Hot pluggable, no software or drivers required
- Easy & quick installation

Switch Features & Options

- Multi lingual on screen display menu
- Control hardware and software systems from a remote location without physically being at the server's location
- Advanced user profiles and configurable OSD hot key combinations
- 12V, 24V and 48V DC Power options

Note: No Daisy chain function on USB Hub KVM model

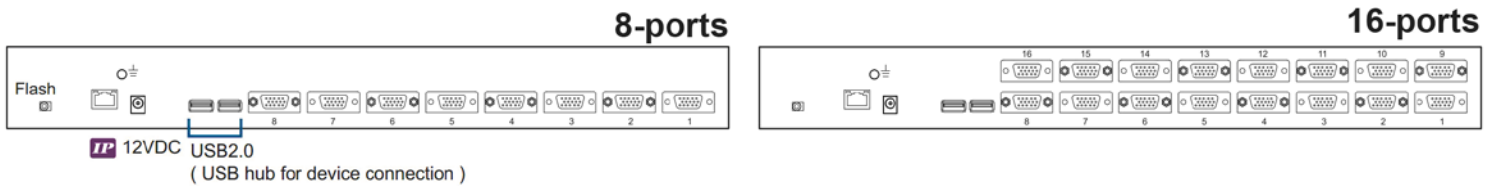

Real View



KVM SPECIFICATIONS

■ KVM Port	
Number of ports:	8 or 16
Connector:	DB-15 combo connector
Connectivity:	Combo 2-in-1 VGA + USB KVM cable, 6, 10 or 15 feet
■ Local Console	
Graphic connector:	1 x DB-15
Resolution:	Up to 1920x1200
Input device:	2 x USB type A for keyboard & mouse
USB hub:	2 x USB type A for sharing other peripheral devices among the computers
■ IP Remote Console	
Connector:	RJ45 Ethernet
User management:	15-user login, 1 x active user
Network protocol:	DHCP / BOOTP / DNS
Security:	SSL v3, RSA, AES, HTTP / HTTPS, CSR
Resolution:	Up to 1600 x 1200
Browser:	IE, Firefox, Safari, Netscape
■ Compatibility	
Multi-platform:	Mix PCs, SUN and Mac G3 / G4 Mac / iMac
Support:	Windows 7 / Vista / 2003 / XP, Linux, Unix

■ Power	
Input:	Auto sensing 100 to 240VAC, 50 / 60 Hz
Option DC:	12V / 24V / 48V DC input
Consumption:	Max. 12 Watt, Standby 5 Watt
■ Regulatory :	
Safety:	FCC & CE certified
Environment:	RoHS2 & REACH compliant
■ Environmental	
Operating:	0 to 50°C
Storage:	-5 to 60°C
Relative humidity:	90%, non-condensing
Shock:	50G peak acceleration (11ms, half-sine wave)
Vibration:	58-100Hz / 0.98G (11ms / cycle)
■ Product Information	
Dimension (W x D x H):	443 x 171 x 44 mm / 17.4 x 6.7 x 1.73 inch
Net weight:	3 kg / 6.5 lb
■ Packing Information	
Dimension (W x D x H):	500 x 400 x 90 mm / 19.7 x 15.7 x 3.5 inch
Gross weight:	5 kg / 11 lb

KVM PORT CONNECTION

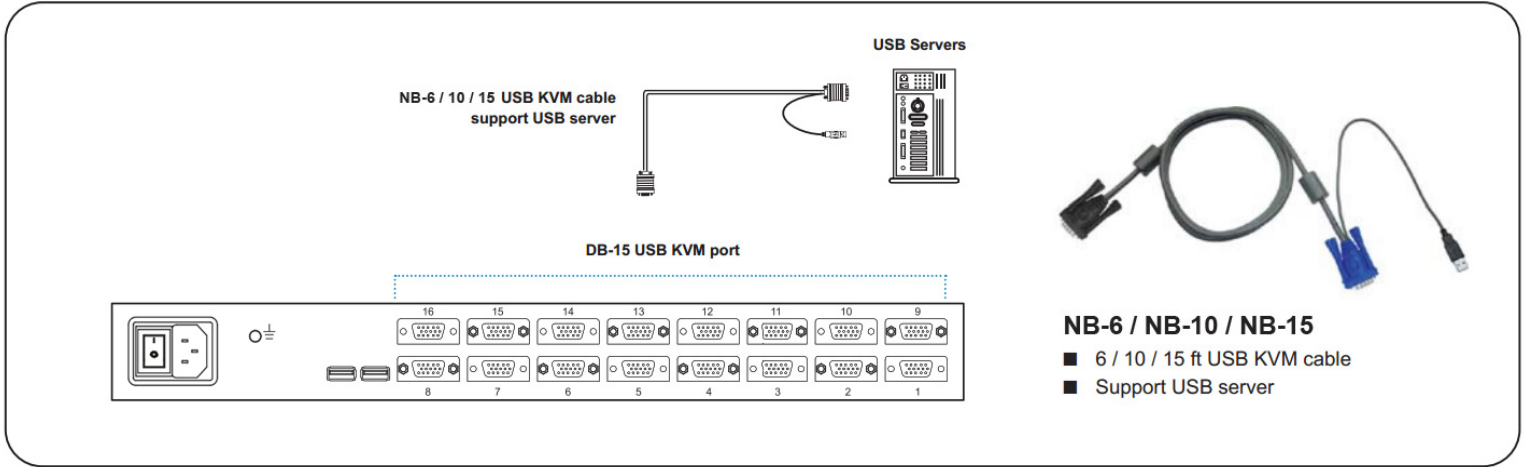

IP & Local console connection

