



# DB-15 KVM

NetView: 1U 17.3" widescreen Full HD 1920 x 1080 LCD console drawer, Matrix DB-15 8-port KVM, w/ CE-6 x 16,2 consoles (1 x local; 1 x remote) with 104 key notepad MAC keyboard w/ Touchpad (e), 18 inch Deep

Model: NW117HD-M018Me



**FEATURES:**

- 1U 17.3" widescreen LCD console drawer
- Support Full HD with 1080p resolution
- 104-key MAC keyboard with either touchpad or trackball
- New enhanced aesthetics with molded front handle
- Short depth design of 460mm(18 inch )Deep

**SPECIFICATIONS:**

LCD Panel	
Diagonal size	17.3" widescreen TFT
Max. Resolution	1920 x 1080
Brightness (cd/m2)	300
Backlight	LED
Colors	16.7M, 8-bit
Contrast Ratio (typ)	1000 : 1
Viewing Angle (H/V)	178° x 178°
Active area (mm)	382 x 215
MTBF (hrs)	15,000
Casing Color	Black ( RAL 9005 )
Weight ( Single console	
Net	10.8 kgs ( 24 lbs )
Gross	15.8 kgs ( 34.8 lbs )
Environmental	
Operating	0 to 55°C Degree
Storage	-20 to 60°C Degree
Relative humidity	5~90%, non-condensing
Shock	10G acceleration ( 11 ms duration )
Vibration	10~300Hz 0.5G RMS random vibration
Regulatory	FCC, CE & CCC certified
Power	
Input	Auto-sensing 100 to 240VAC, 50 / 60Hz
Consumption	Max. 48 Watt, Standby 5 Watt
Product Dimensions ( Single console )	
Product	441.6 x 584.2 x 44 mm / 17.4 x 23 x 1.73 inch
Packing	589.28 x 762 x 152.4 mm / 23.2 x 30 x 6 inch

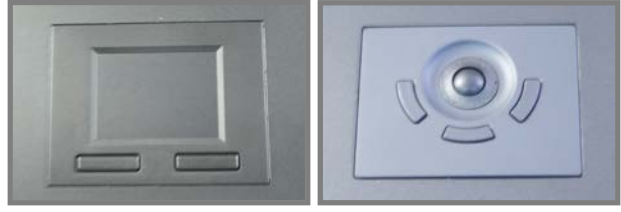

## MAC Keyboard / Mouse Options

**Me** MAC keyboard integrated with touchpad



**Mb** MAC keyboard integrated with trackball



### Supporting layouts

America



United States

## How to Use "MAC" Keyboard

### Keyboard Features



**F1**  
Decrease display brightness



**F9**  
Fast-forward



**F2**  
Increase display brightness



**F10**  
Mute sound



**F3**  
Mission control  
\* Only works with OS X Lion  
default Keyboard Shortcuts.



**F11**  
Decrease volume



**F4**  
Dashboard



**F12**  
Increase volume



**F7**  
Rewind



**Eject disc**



**F8**  
Play / Pause



**Command**

## STRUCTURE DIAGRAM

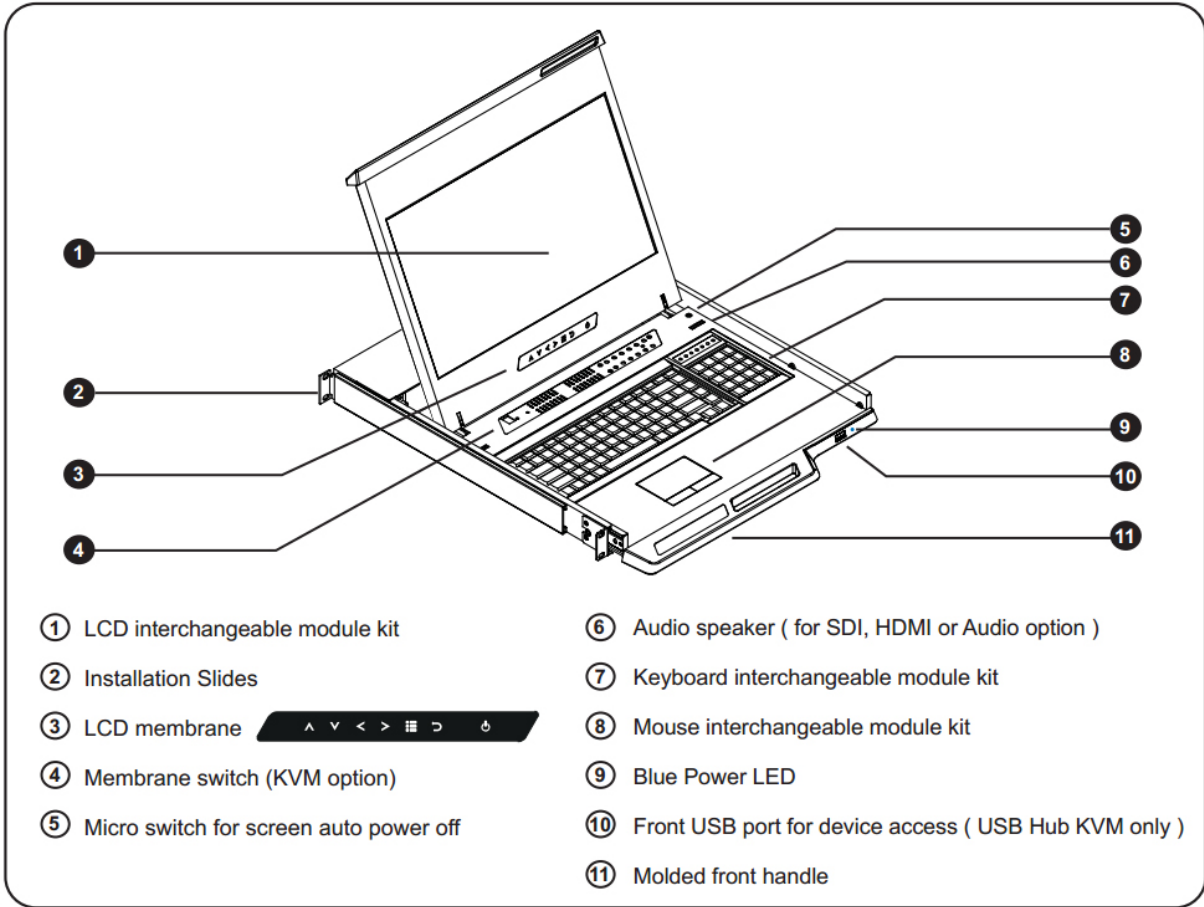

## KVM PORT CONNECTION

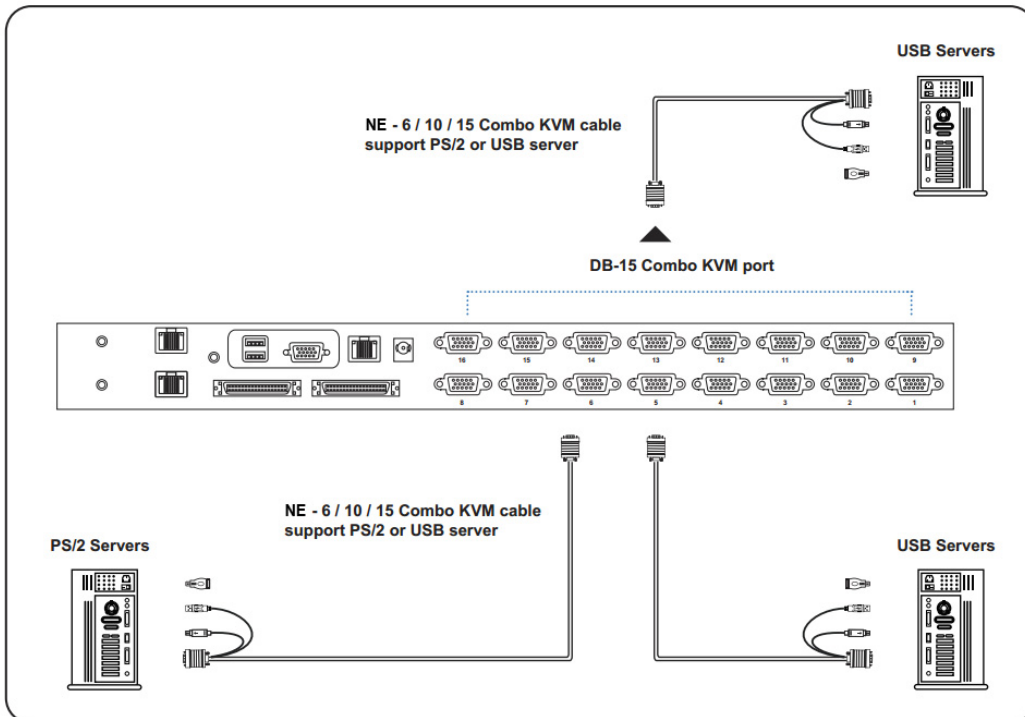

**NE-6 / NE-10 / NE-15**  
 ■ 6 / 10 / 15 ft Combo KVM cable  
 ■ Support PS/2 or USB server

## Matrix DB-15 KVM Benefits

- Efficient system management with simultaneous multi-user access
- Support resolution up to 1920 x 1080
- SUN 1152 x 900 resolution compatible
- Multi-platform servers shared by different consoles in cascade connection
- Mix PS/2, USB & SUN with Multi-Platform switch capability Extended Cat6 cord remote access up to 150 meters
- Provide a diversity of consoles to access servers independently & simultaneously

## Switch Features & Options

- Greater distances between your switch and servers allow enhanced data center rack layouts
- Multi lingual on screen display menu
- Advanced user profiles and configurable OSD hot key combinations

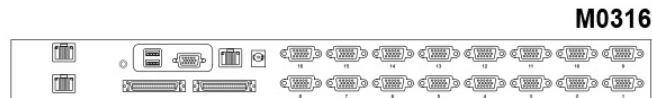
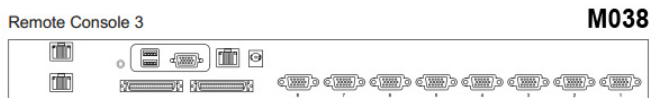
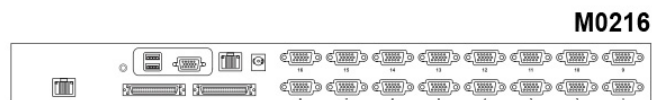
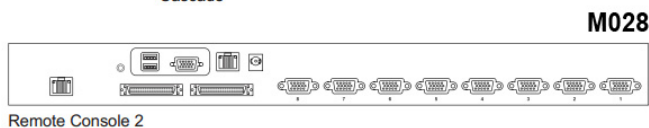
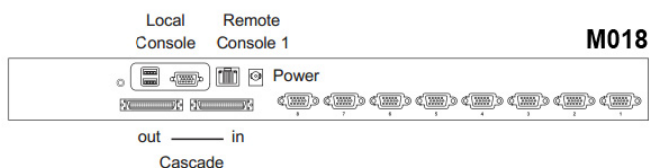

## KVM SPECIFICATIONS

<b>■ KVM Port</b>	
Number of ports:	8 or 16
Connector:	DB-15 combo connector
Connectivity:	Combo 4-in-1 KVM cable up to 6, 10 & 15 feet
<b>■ Local Console</b>	
Monitor port:	1 x DB-15 VGA (Up to 1920 x 1080 /1920 x 1200)
Keyboard & mouse port:	2 x USB type connector for keyboard & mouse
<b>■ CAT6 Remote Console</b>	
Number of remote port:	1 for M018 / M0116 2 for M028 / M0216 3 for M038 / M0316
Monitor port:	DB15-pin VGA (Up to 1600 x 1200)
Keyboard & mouse port:	2 x USB type connector for keyboard & mouse
Remote I/O:	RJ45 via Cat5 / Cat5e / Cat6 cable up to 500 feet
<b>■ Expansion</b>	Up to 256 servers by 8-level cascade
<b>■ Compatibility</b>	
Multi-platform:	Mix PCs, SUN and Mac G3 / G4 Mac / iMac
Support:	Windows 7 / Vista / 2003 / XP, Linux, Unix

<b>■ Power</b>	
Input:	AC power adapter
Consumption:	Max. 48 Watt, Standby 5 Watt
<b>■ Regulatory :</b>	
Safety:	cUL, FCC & CE certified
Environment:	RoHS2 & REACH compliant
<b>■ Environmental</b>	
Operating:	0 to 50°C
Storage:	-5 to 60°C
Relative humidity:	90%, non-condensing
Shock:	50G peak acceleration (11ms, half-sine wave)
Vibration:	58-100Hz / 0.98G (11ms / cycle)
<b>■ Product Information</b>	
Dimension (W x D x H):	443 x 171 x 44 mm / 17.4 x 6.7 x 1.73 inch
Net weight:	3 kg / 6.5 lb
<b>■ Packing Information</b>	
Dimension (W x D x H):	500 x 400 x 90 mm / 19.7 x 15.7 x 3.5 inch
Gross weight:	5 kg / 11 lb

# REMOTE & LOCAL CONSOLE CONNECTION

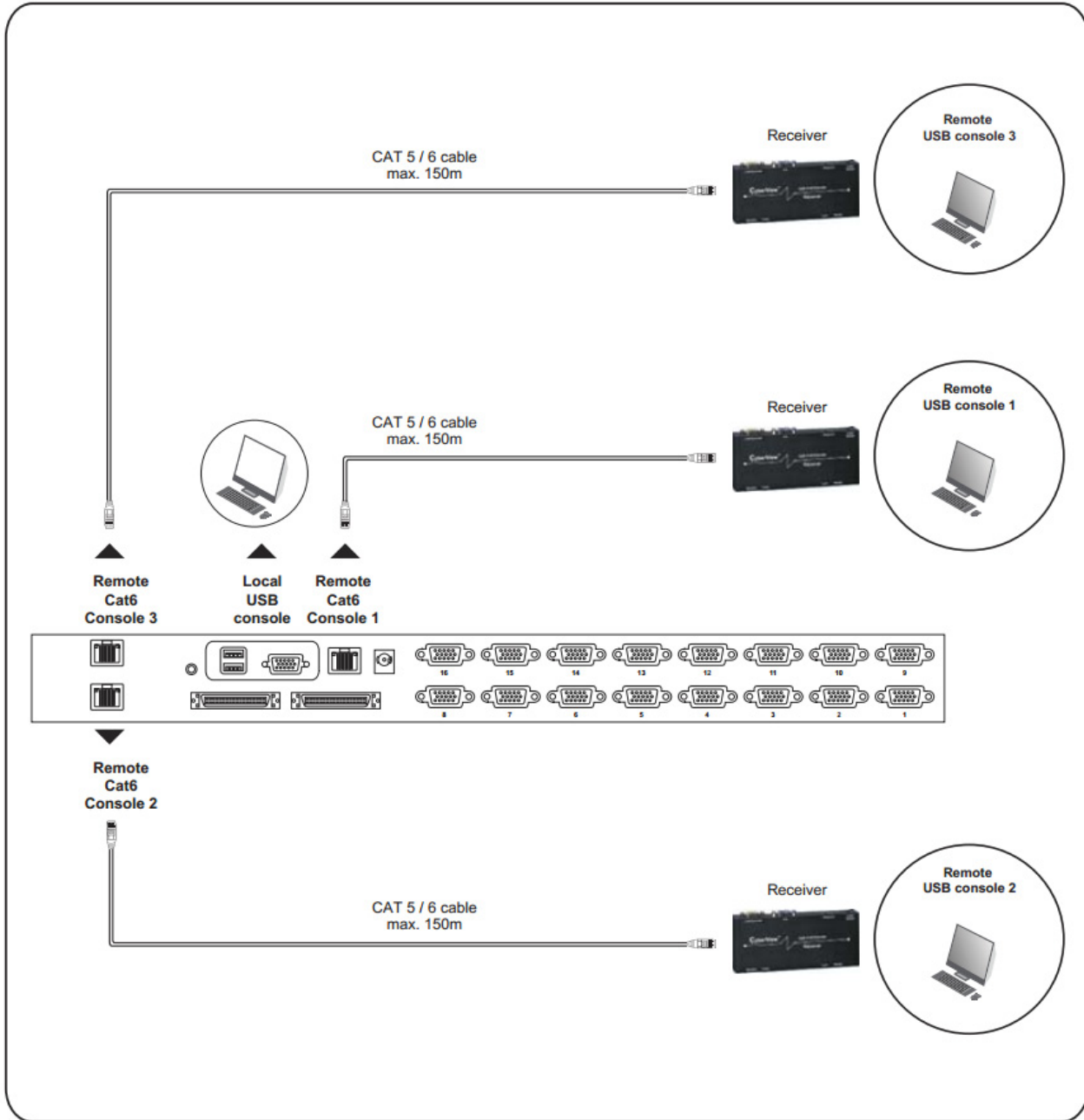

## KVM CASCADE

- Cascade up to 8 levels, 240 servers
- Cascading multiple KVM with CMC-8 cascade cable

### Master KVM

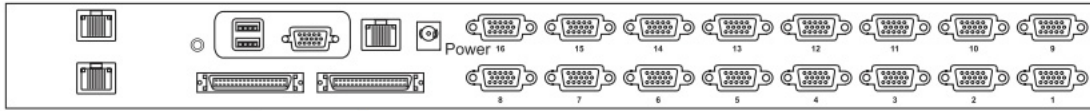

out — in  
Cascade

To cascade IN port

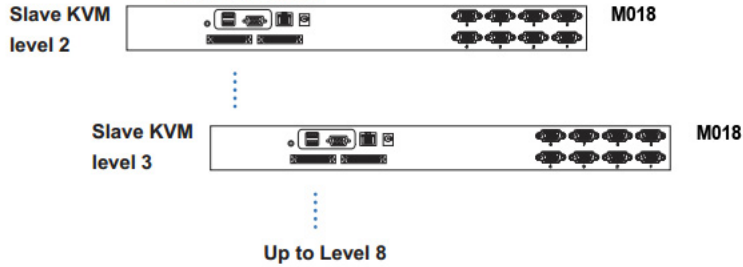

Cascaded KVMs from level 2 to 8 must be the models of M018 / M0116 or MC0116 / MC0132.



When multiple matrix KVMs cascade together, the master KVM at level 1 will take all control of other slave KVM switches (e.g. level 2 to 8).



The slave matrix KVM will be as a port expansion module of the master matrix KVM, the original remote console on slave KVM will be sacrificed and disabled.



### CMC-8

- 8ft Matrix KVM cascade cable