

# USB HUB KVM

NetView:1U Rackmount 17" Wide 1920 x 1200 WUXGA 16-ports USB RGB KVM switch (Includes 16 pcs 6ft long NB-6 Cables) and 2 x USB 2.0 port sharing USB peripheral for computers, with 104 key notepad MAC keyboard w/ Trackball (b), 23 inch Deep

Model: NW117X-BM16b



**FEATURES:**

- 1U 17" widescreen LCD console drawer
- Front USB port for device access (USB Hub KVM only)
- 1920 x 1200 native WUXGA Ultra high resolution
- PIP & Picture by Picture viewing efficiency
- 104-key notepad MAC keyboard with either touchpad or trackball
- New enhanced aesthetics with molded front handle
- 2 post rack mounting available
- Short depth design of 580mm(23 inch) Deep

**SPECIFICATIONS:**

LCD Panel	
Diagonal size	17" widescreen TFT
Max. Resolution	1920 x 1200
Brightness (cd/m2)	210
Backlight	LED
Colors	16.7 M, 8-bit
Contrast Ratio (typ)	600 : 1
Viewing Angle (H/V)	130° x 110°
Active area (mm)	367 x 230
MTBF (hrs)	20,000
Signal input	VGA, DVI-D, HDMI
Casing Color	Black ( RAL 9005 )
Weight ( Single console	
Net	10.9 kgs ( 24 lbs )
Gross	15.8 kgs ( 34.8 lbs )
Environmental	
Operating	0 to 50°C Degree
Storage	-5 to 60°C Degree
Relative humidity	5-90%, non-condensing
Shock	10G acceleration ( 11 ms duration )
Vibration	5-500Hz 1G RMS random vibration
Regulatory	FCC, CE
Power	
Input	Auto-sensing 100 to 240VAC, 50 / 60Hz
Consumption	Max. 48 Watt, Standby 5 Watt
<b>Product Dimensions ( Single console )</b>	
Product	441.6 x 580 x 44 mm / 17.4 x 23 x 1.73 inch
Packing	590 x 823 x 140 mm / 23.2 x 32.4 x 5.5 inch



## MAC Keyboard / Mouse Options

**Me** MAC keyboard integrated with touchpad

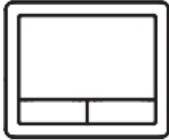

**Mb** MAC keyboard integrated with trackball



### Supporting layouts

America



United States

## How to Use "MAC" Keyboard

### Keyboard Features



**F1**  
Decrease display brightness



**F9**  
Fast-forward

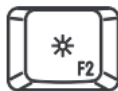

**F2**  
Increase display brightness



**F10**  
Mute sound



**F3**  
Mission control  
\* Only works with OS X Lion  
default Keyboard Shortcuts.



**F11**  
Decrease volume



**F4**  
Dashboard



**F12**  
Increase volume



**F7**  
Rewind



**Eject disc**

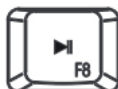

**F8**  
Play / Pause



**Command**

## STRUCTURE DIAGRAM

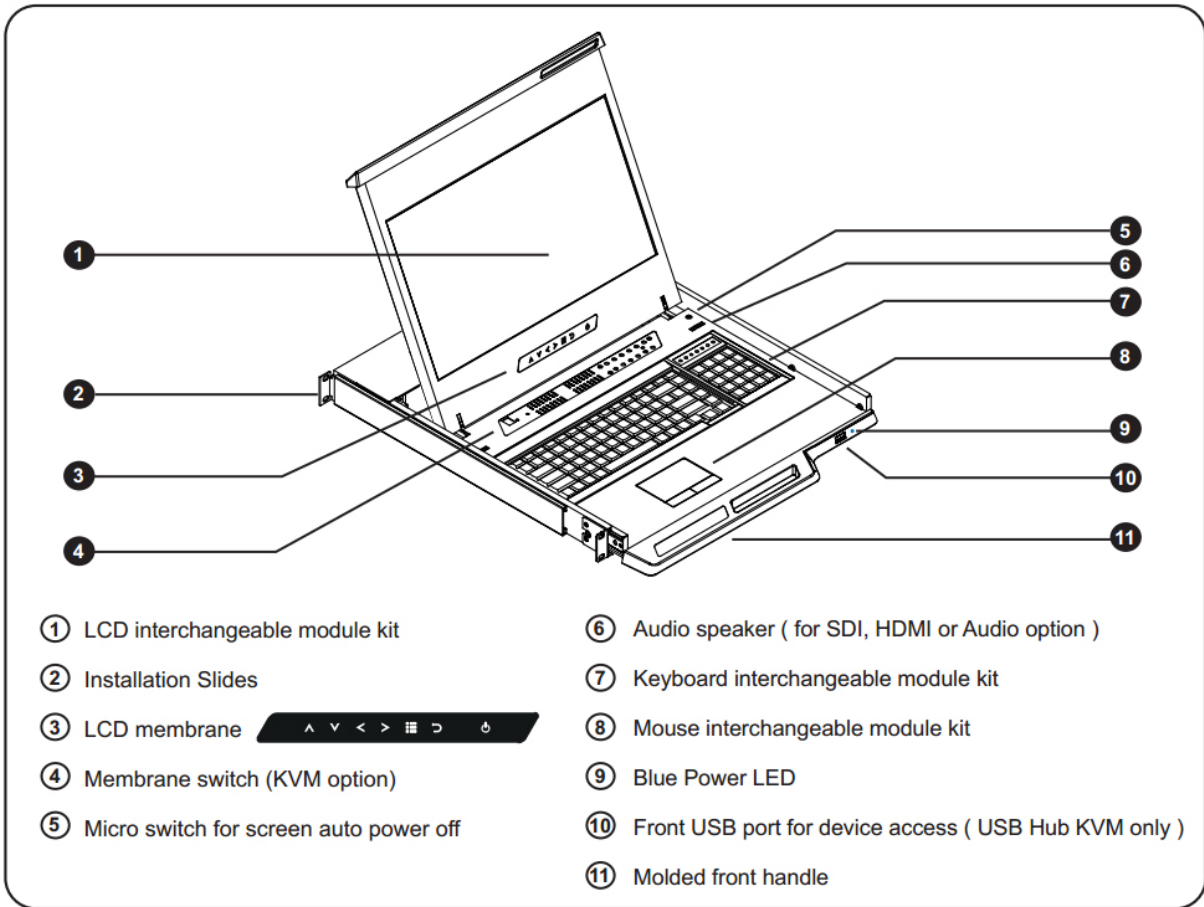

## BUILT-IN USB HUB USAGE & CONNECTION

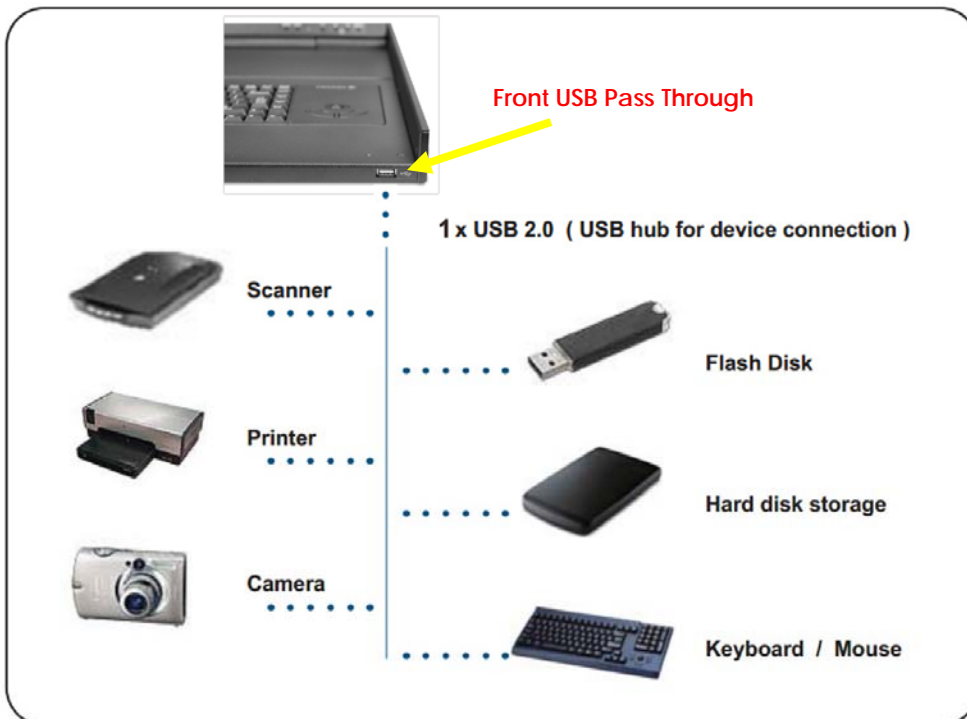

## USB Hub DB-15 KVM Benefits

- VGA-USB DB-15 KVM with either 8 or 16 ports in 1U
- 2 x USB 2.0 port sharing USB peripheral for computers
- Mix USB & SUN with Multi-Platform switch capability
- Support resolution up to 1920 x 1080
- SUN 1152 x 900 resolution compatible
- Hot pluggable, no software or drivers required
- Easy & quick installation

## Switch Features & Options

- Multi lingual on screen display menu
- Advanced user profiles and configurable OSD hot key combinations
- 12V, 24V and 48V DC Power options

**Note: No Daisy chain function on USB Hub KVM model**

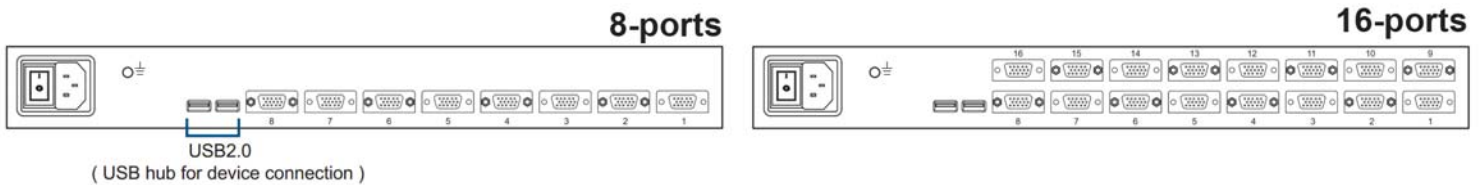

## Real View



## KVM SPECIFICATIONS

<b>■ KVM Port</b>	
Number of ports:	8 or 16
Connector:	DB-15 combo connector
Connectivity:	Combo 2-in-1 VGA + USB KVM cable, 6, 10 or 15 feet
<b>■ Local Console</b>	
Graphic Connector:	1 x DB-15
Resolution:	Up to 1920 x 1200
Input device:	2 x USB type A for keyboard & mouse
USB hub:	2 x USB type A for sharing other peripheral devices among the computers
<b>■ Management</b>	
Multilingual OSD:	English, France, German, Spanish, Italian, Russian, Simplified Chinese, Japanese
Hotkey Combination:	Scroll-lock, Cap-lock, Num-lock, Alt, Ctrl & Win
Security:	Password enable & Disable, up to 8 users profile for port access
PC Selection:	Front button, OSD menu & Hotkey
<b>■ Compatibility</b>	
Multi-platform:	Mix PCs, SUN and Mac G3 / G4 Mac / iMac
Support:	Windows 7 / Vista / 2003 / XP, Linux, Unix

<b>■ Power</b>	
Input:	Auto sensing 100 to 240VAC, 50 / 60 Hz
Option DC:	12V / 24V / 48V DC input
Consumption:	Max. 12 Watt, Standby 5 Watt
<b>■ Regulatory :</b>	
Safety:	FCC & CE certified
Environment:	RoHS2 & REACH compliant
<b>■ Environmental</b>	
Operating:	0 to 50°C
Storage:	-5 to 60°C
Relative humidity:	90%, non-condensing
Shock:	50G peak acceleration (11ms, half-sine wave)
Vibration:	58-100Hz / 0.98G (11ms / cycle)
<b>■ Product Information</b>	
Dimension (W x D x H):	443 x 171 x 44 mm / 17.4 x 6.7 x 1.73 inch
Net weight:	3 kg / 6.5 lb
<b>■ Packing Information</b>	
Dimension (W x D x H):	500 x 400 x 90 mm / 19.7 x 15.7 x 3.5 inch
Gross weight:	5 kg / 11 lb

## KVM PORT CONNECTION

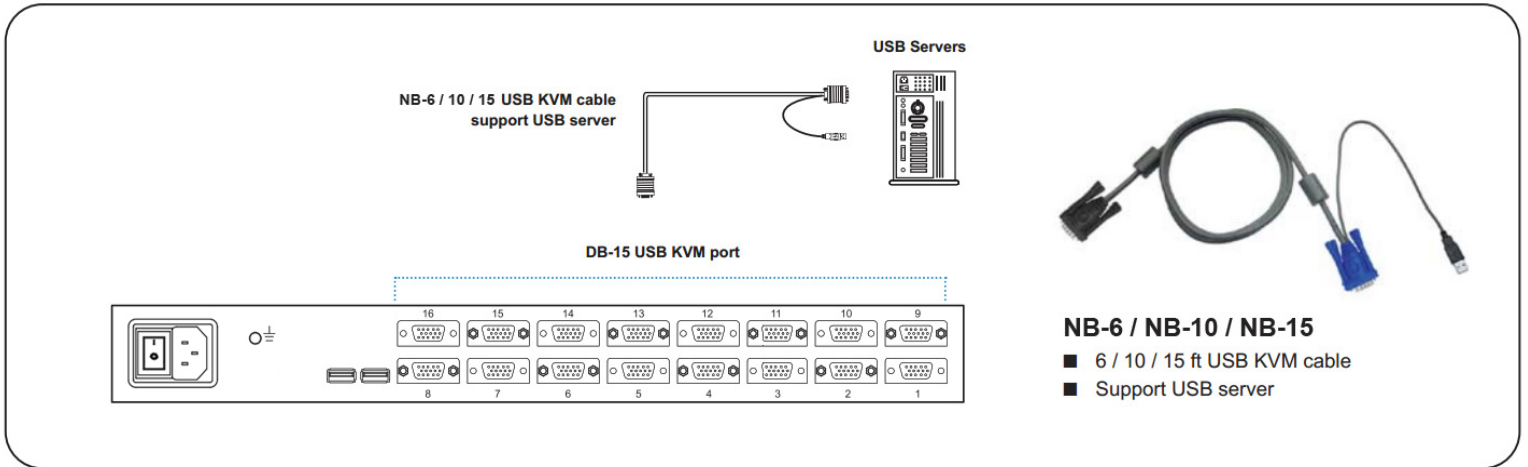

## Front Panel - Port LED Indications

