

CAT6 KVM

NetView:1U Rackmount 19" Wide 1440 x 900 LCD KVM with 104 key notepad keyboard w/ Trackball (b), Integrated with Combo Cat6,32 KVM Ports + 0 User Via CAT5 Extender + 0 Users Via KVM over IP. Over Depth is 18.1 Inch. Dongles sold separately

Model: NW119C32b



FEATURES:

- 1U 19" widescreen LCD console drawer
- 104-key keyboard with either touchpad or trackball
- Green LED-backlit panel technology
- New enhanced aesthetics with molded front handle
- Short depth design of 580mm (18.1") only
- 2 post rack mounting available

SPECIFICATIONS:

| | |
|---------------------------------------|---|
| LCD Panel | |
| Diagonal size | 19" widescreen TFT |
| Max. Resolution | 1440 x 900 |
| Brightness (cd/m2) | 250 |
| Backlight | LED |
| Colors | 16.7 M |
| Contrast Ratio (typ) | 1000 : 1 |
| Viewing Angle (H/V) | 160° x 160° |
| Active area (mm) | 408 x 255 |
| MTBF (hrs) | 30,000 |
| Signal input | VGA or DVI-D |
| Casing Color | Black (RAL 9005) |
| Weight (Single console | |
| Net | 11.5 kgs (25 lbs) |
| Gross | 16.3 kgs (36 lbs) |
| Environmental | |
| Operating | 0 to 50°C Degree |
| Storage | -5 to 60°C Degree |
| Relative humidity | 5-90%, non-condensing |
| Shock | 10G acceleration (11 ms duration) |
| Vibration | 5-500Hz 1G RMS random vibration |
| Regulatory | FCC, CE |
| Power | |
| Input | Auto-sensing 100 to 240VAC, 50 / 60Hz |
| Consumption | Max. 48 Watt, Standby 5 Watt |
| Product Dimensions (Single console) | |
| Product | 441.6 x 460 x 44 mm / 17.4 x 18.1 x 1.73 inch |
| Packing | 590 x 808 x 140 mm / 23.2 x 31.8 x 5.5 inch |

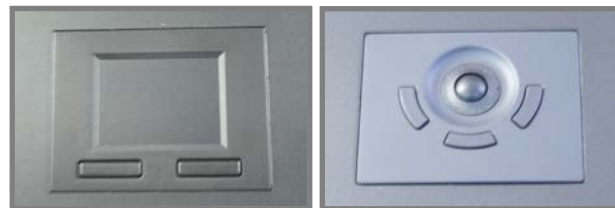

HOW TO USE THE DRAWER:



- Hold the handle and slide out the drawer.



- Flip up the LCD to a suitable angle



- Operate the LCD console drawer.

DIMENSION:

Front View

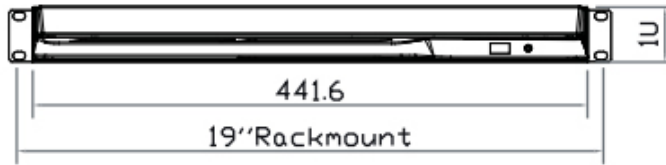

Rear View



UNIT : mm
1mm = 0.03937 inch

Side View

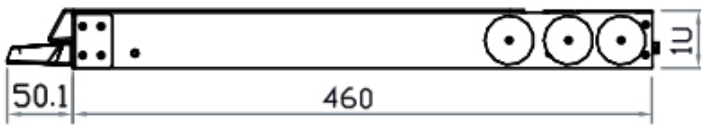

Top View

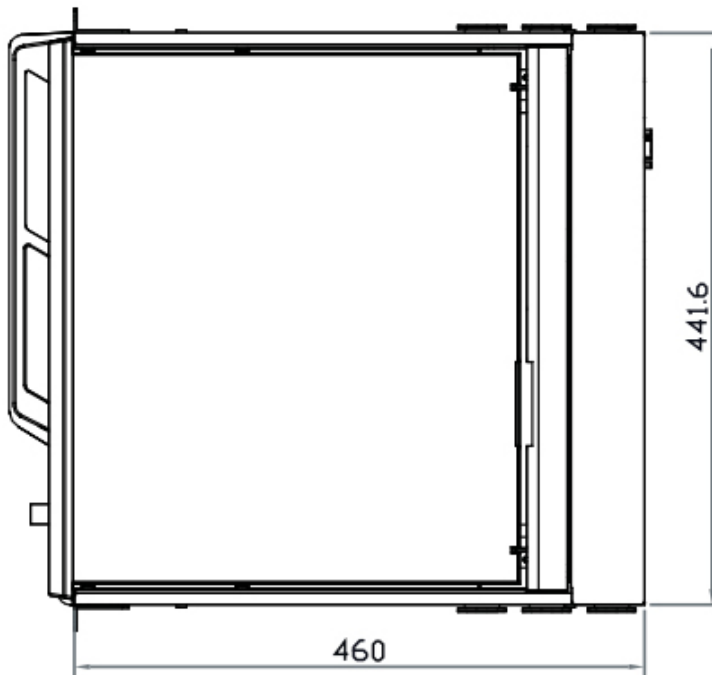

STANDARD KEYBOARD

e e keyboard integrated with touchpad

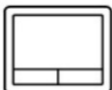

b b keyboard integrated with trackball



Supporting layouts

| | | |
|----------------|--|----------------|
| America | | United States |
| EMEA | | United Kingdom |
| | | Germany |
| | | France |
| | | Spain |
| | | Norway |
| | | Italy |
| | | Russia |
| | | Switzerland |
| | | Netherlands |
| | | Portugal |
| Asia | | China |
| | | Japan |
| | | Korea |
| | | Arabia |
| | | Turkey |

STRUCTURE DIAGRAM

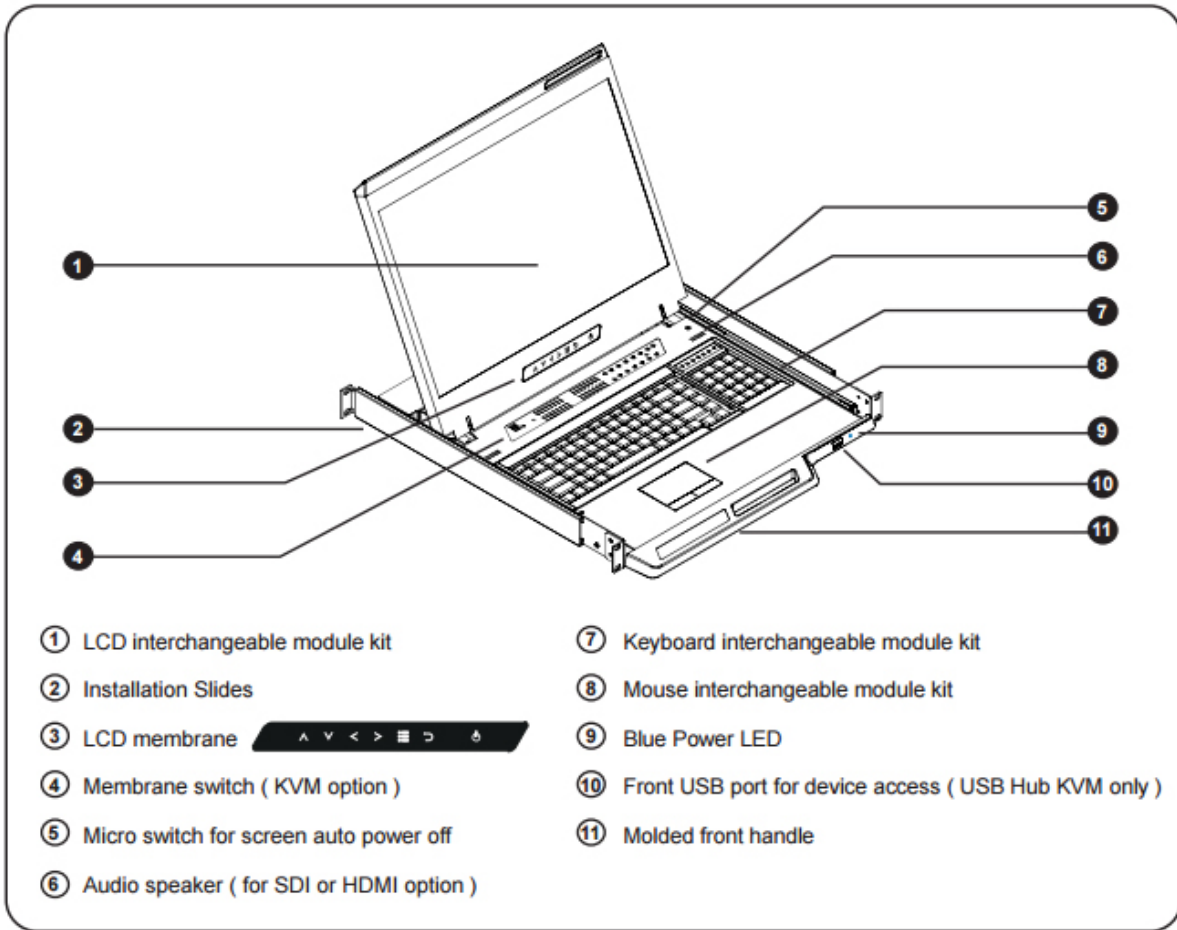

KVM PORT & CAT6 DONGLE CONNECTION

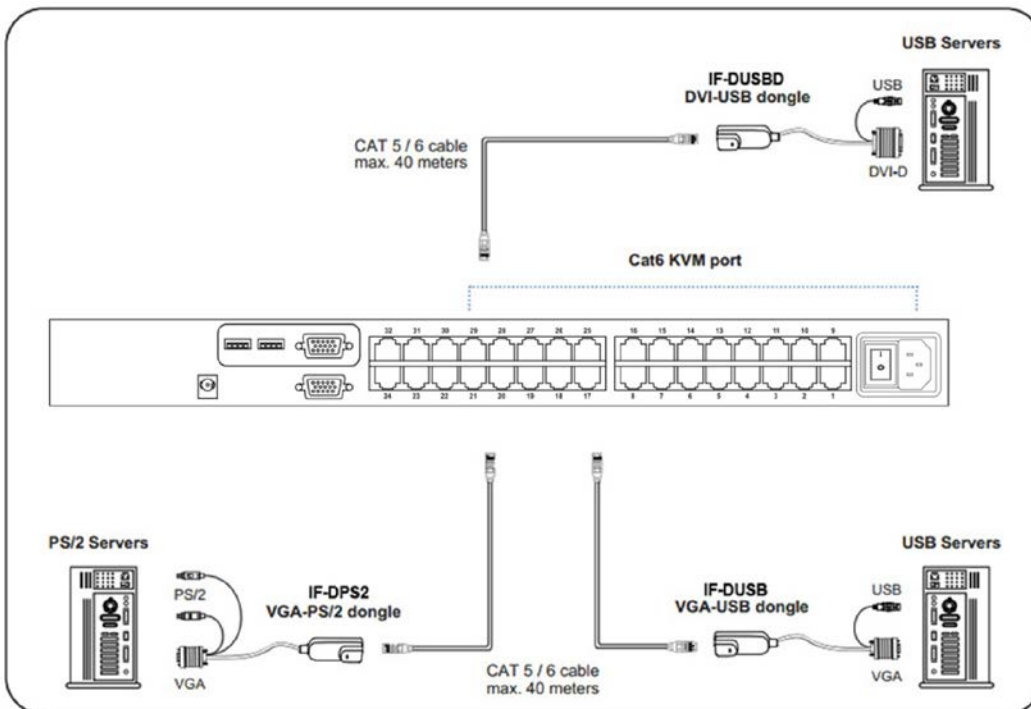

IF-DUSBD DVI-USB dongle

- To connect DVI-D connector to the computer's video card
- To connect USB connector to the computer's USB port



IF-DUSB VGA-USB dongle

- To connect DB-15 connector to the computer's video card
- To connect USB connector to the computer's USB port



IF-DPS2 VGA-PS/2 dongle

- To connect DB-15 connector to the computer's video card
- To connect PS/2 keyboard connector to the computer's keyboard port
- To connect PS/2 mouse connector to the computer's mouse port

| Cat6 Dongle | EDID Resolution Hard-coded | Resolutions Capable | | | |
|-------------|----------------------------------|---------------------|-------------|-------------|------------|
| | | 4:3 | | | 16:10 |
| | | 1024 x 768 | 1280 x 1024 | 1600 x 1200 | 1440 x 900 |
| IF-DPS2 | 1600 x 1200 | ✓ | ✓ | ✓ | ✓* |
| IF-DUSB | 1600 x 1200 | ✓ | ✓ | ✓ | ✓* |
| IF-DUSBD | 1280 x 1024 | ✓ | ✓ | ✗ | ✗ |

* Requires the user to enable showing unsupported resolutions via the target computer's video adapter settings (effectively ignoring the DDC / EDID)

KVM CASCADE

- Cascade up to 8 levels, 256 servers
- Cascading multiple KVM with CBC-6 cascade cable

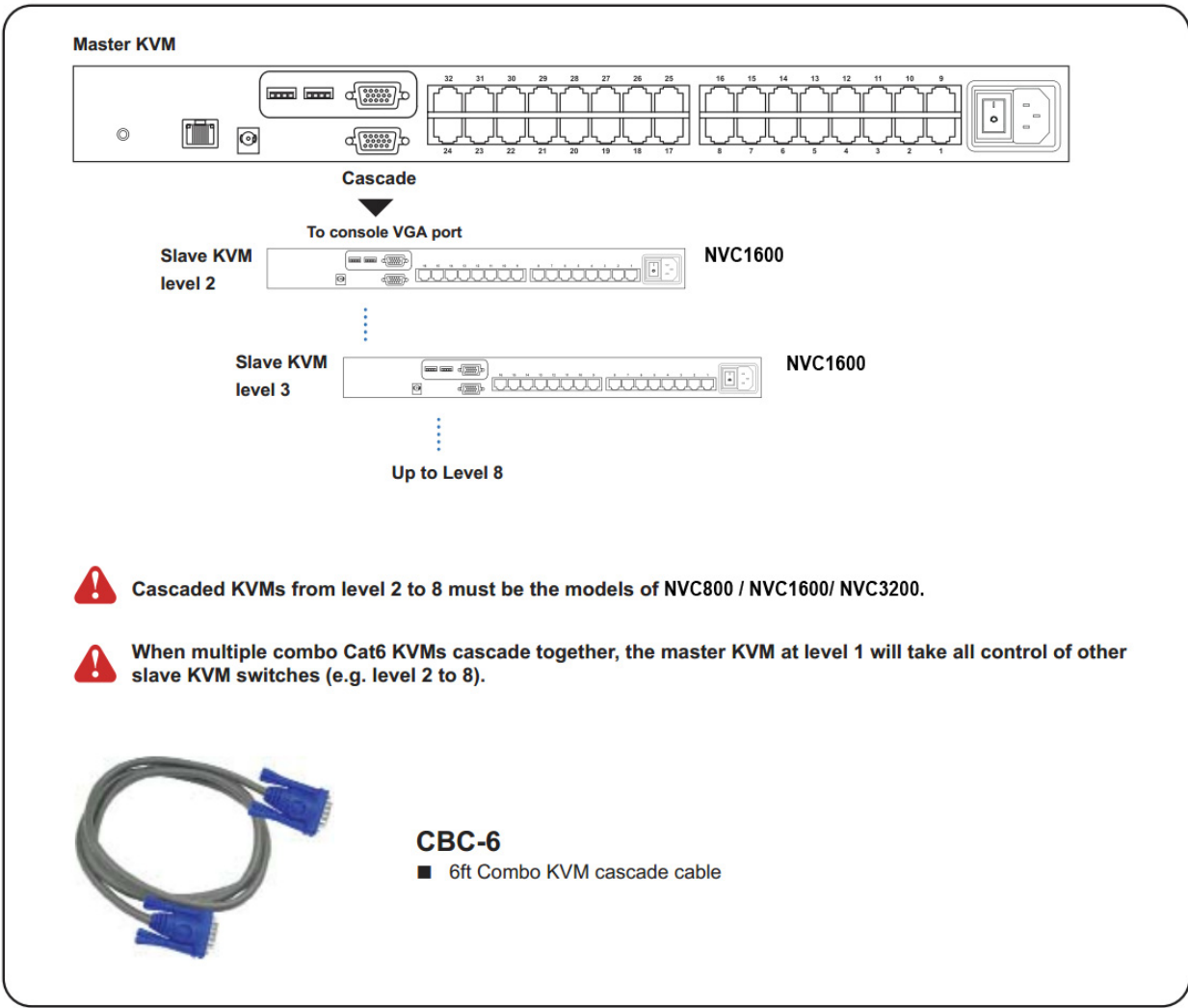

Combo Cat6 2-console KVM Benefits

- Combo Cat6 KVM with either 8, 16 or 32 ports in 1U
- Up to 40 meters between your servers & KVM ports
- Cascade switches up to 8 levels & Mix switches between Cat6 & Combo DB-15 KVM
- Support DVI-USB, VGA-USB & VGA-PS/2 server interface
- Mix PS/2, USB & SUN with Multi-Platform switch capability

Switch Features & Options

- Multi lingual on screen display menu
- Advanced user profiles and configurable OSD hot key combinations
- Dual power with failover
- 12V, 24V and 48V DC Power options



KVM SPECIFICATIONS

| | |
|------------------------|---|
| ■ KVM Port | |
| Number of ports: | 8, 16 or 32 |
| Connector: | RJ-45 |
| Connectivity: | DVI-D / VGA connector dongle up to 40 meters (132 feet) via Cat6 / Cat5 cable |
| ■ Management | |
| Multilingual OSD: | English, France, German, Spanish, Italian, Russian, Simplified Chinese, Japanese |
| Hotkey combination: | Scroll-lock, Cap-lock, Num-lock, Alt, Ctrl & Win |
| Security: | Password enable & disable, up to 8 users profile for port access |
| PC Selection: | Front button, OSD menu & hotkey |
| ■ Local Console | |
| Graphic Connector: | 1 x DB-15 VGA |
| Resolution: | Up to 1600 x 1200 |
| Input device: | 2 x USB type A for keyboard & mouse |
| Resolution support: | 4:3 - max. 1600 x 1200 16:10 - max. 1440 x 900 |
| ■ Expansion: | Up to 256 servers by 8-level cascade |
| ■ Compatibility | |
| Multi-platform: | Mix PCs, SUN and Mac G3 / G4 Mac / iMac |
| Support: | Windows 7 / Vista / 2003 / XP, Linux, Unix |
| ■ Power | |
| Input: | Auto sensing 100 to 240VAC, 50 / 60 Hz OR AC / DC power adapter 12V@3.3A (optional) |
| Option DC: | 12V / 24V / 48V DC input |
| Consumption: | Max. 24 Watt, Standby 5 Watt |

| | |
|------------------------------|--|
| ■ Regulatory : | |
| Safety: | cUL, FCC & CE certified |
| Environment: | RoHS2 & REACH compliant |
| ■ Environmental | |
| Operating: | 0 to 50°C |
| Storage: | -5 to 60°C |
| Relative humidity: | 90%, non-condensing |
| Shock: | 50G peak acceleration (11ms, half-sine wave) |
| Vibration: | 58-100Hz / 0.98G (11ms / cycle) |
| ■ Product Information | |
| Dimension (W x D x H): | 443 x 171 x 44 mm / 17.4 x 6.7 x 1.73 inch |
| Net weight: | 3 kg / 6.5 lb |
| ■ Packing Information | |
| Dimension (W x D x H): | 500 x 400 x 90 mm / 19.7 x 15.7 x 3.5 inch |
| Gross weight: | 5 kg / 11 lb |