

SDR Series

1U Sun Compatible Dual Slide LCD Console Drawer CAT6KVM



CAT6 KVM

1U Sun Compatible 19" Dual Slide 1280x1024 LCD Console Drawer with 104 key notepad keyboard w/ Touchpad (e), Integrated with Matrix Cat6,32 KVM Ports + 1 User Via CAT5 Extender + 2 Users Via KVM over IP. Over Depth is 26 Inch. Dongles sold separately

Model: SDR119MC2132e



FEATURES:

- 1U dual slide 19" LCD console drawer
- Direct Support for SUN Micro 1280 x 1024 native resolution
- 104-key keyboard with touchpad
- Enhanced aesthetics with new molded front panel and two point lock
- Short depth design of 650mm(26 inch) Deep

SPECIFICATIONS:

LCD Panel	
Diagonal size	19" TFT
Max. Resolution	1280 x 1024 (Native)
Brightness (cd/m2)	250
Backlight	CCF
Colors	16.7M
Contrast Ratio (typ)	1000 : 1
Viewing Angle (H/V)	160° x 160°
Active area (mm)	376 x 301
MTBF (hrs)	50,000
Casing Color	Black (RAL 9005)
Weight (Single console	
Net	13.2 kgs (29 lbs)
Gross	19 kgs (41.8 lbs)
Environmental	
Operating	0 to 50°C Degree
Storage	-5 to 60°C Degree
Relative humidity	5-90%, non-condensing
Shock	10G acceleration (11 ms duration)
Vibration	5-500Hz 1G RMS random vibration
Power	
Input	Auto-sensing 100 to 240VAC, 50 / 60Hz
Consumption	Max. 48 Watt, Standby 5 Watt
Product Dimensions (Single console)	
Product	441.6 x 650 x 44 mm / 17.4 x 25.6 x 1.73 inch
Packing	595 x 860 x 140 mm / 23.4 x 33.9 x 5.5 inch

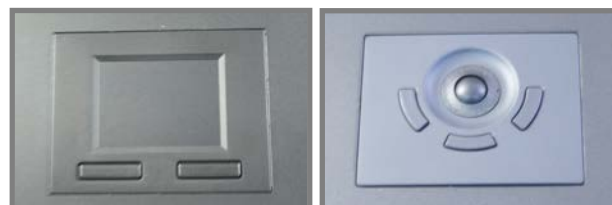

HOW TO USE THE DUAL SLIDES



- Press the handle button and gently slide out the drawer..



- Flip up the LCD to a suitable angle.

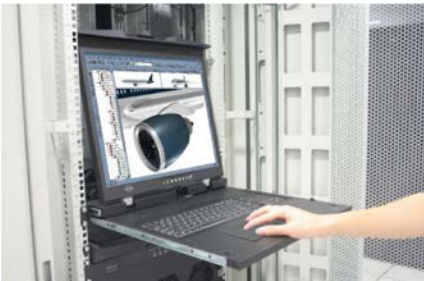

- Operate the LCD console drawer.



- Flip down the front panel.



- Press the handle button and gently push back the drawer into the rack.



- Return the LCD console drawer to park position.

DIMENSION

Front View

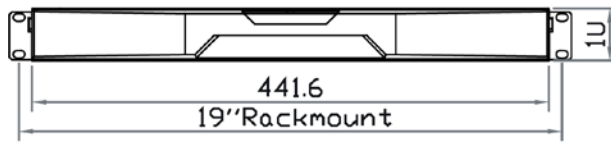

Rear View



Side View



UNIT : mm
1mm = 0.03937 inch

Top View

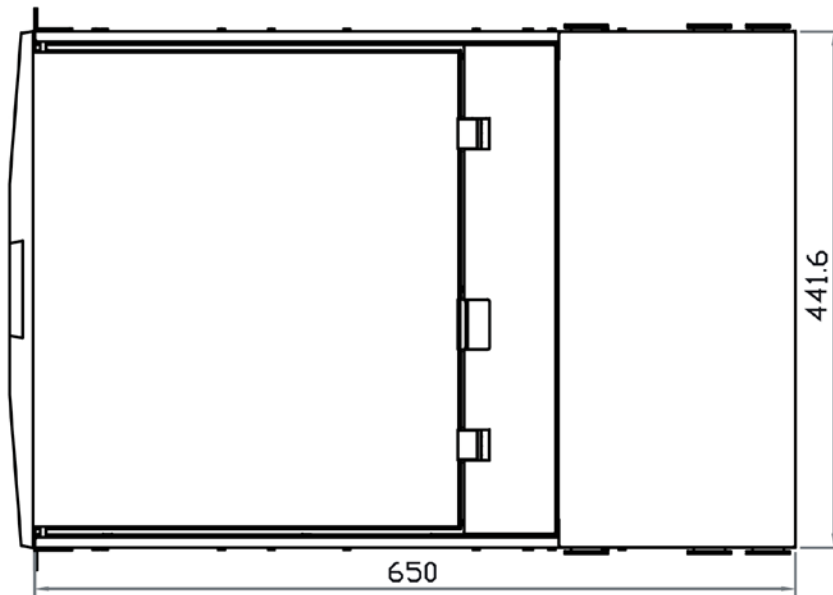

STANDARD KEYBOARD

e keyboard integrated with touchpad



Supporting layouts

America



United States

STRUCTURE DIAGRAM



KVM PORT & CAT6 DONGLE CONNECTION

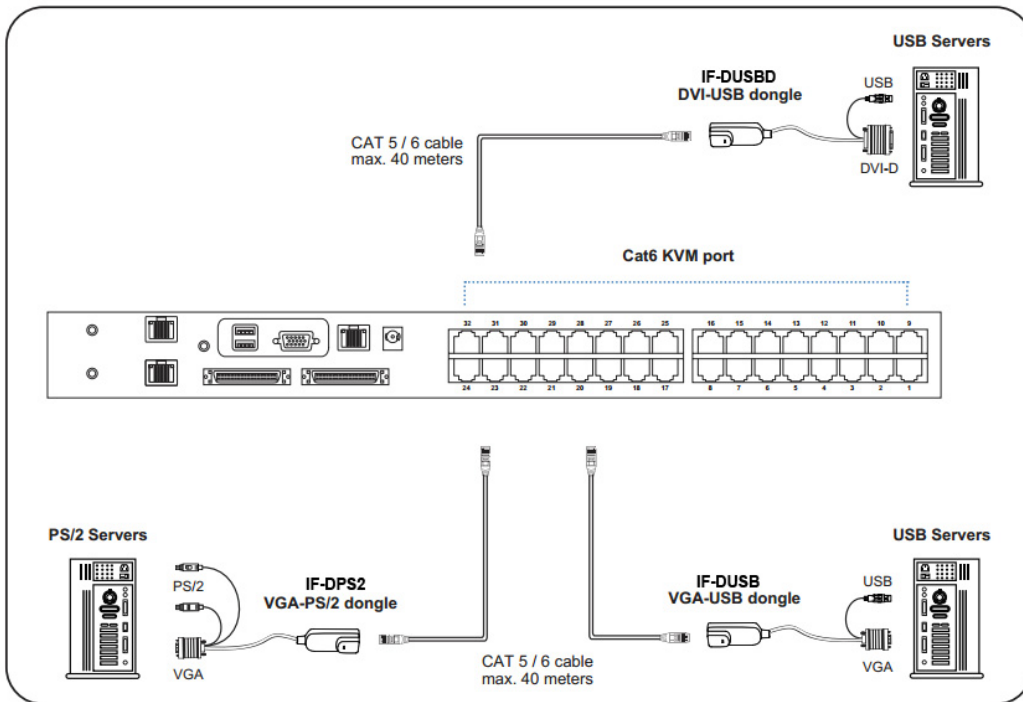

IF-DUSBD DVI-USB dongle

- To connect DVI-D connector to the computer's video card
- To connect USB connector to the computer's USB port



IF-DUSB VGA-USB dongle

- To connect DB-15 connector to the computer's video card
- To connect USB connector to the computer's USB port



IF-DPS2 VGA-PS/2 dongle

- To connect DB-15 connector to the computer's video card
- To connect PS/2 keyboard connector to the computer's keyboard port
- To connect PS/2 mouse connector to the computer's

Cat6 Dongle	EDID Resolution Hard-coded	Resolutions Capable			
		4:3			16:10
		1024 x 768	1280 x 1024	1600 x 1200	1440 x 900
IF-DPS2	1600 x 1200	✓	✓	✓	✓*
IF-DUSB	1600 x 1200	✓	✓	✓	✓*
IF-DUSBD	1280 x 1024	✓	✓	✗	✗

* Requires the user to enable showing unsupported resolutions via the target computer's video adapter settings (effectively ignoring the DDC / EDID)

IP, REMOTE & LOCAL CONSOLE CONNECTION



Matrix Cat6 IP KVM Benefits

- Secure IP remote user access across the world wide web
- Efficient system management with simultaneous multi-user access
- Capable of connecting 32 or 16 servers per device in 1U
- Support DVI-USB, VGA-USB & VGA-PS/2 server interface
- Up to 40 meters between your server & KVM switch
- Enhanced Cat6 cable management with remote access up to 150m

Switch Features & Options

- Provide a diversity of console to access servers independently and simultaneously
- Use of the RJ45 Cat6 interface allows for a higher number of ports in smaller density
- Greater distances between your switch and servers allow enhanced data center rack layouts
- Multi lingual on screen display menu
- Advanced user profiles and configurable OSD hot key combinations

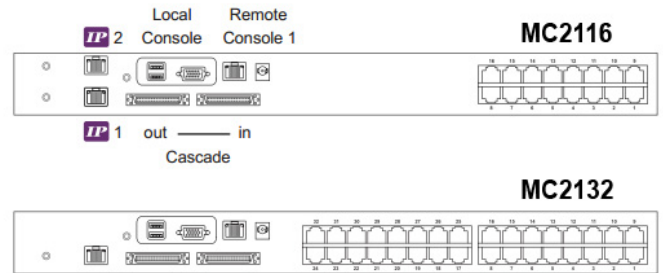
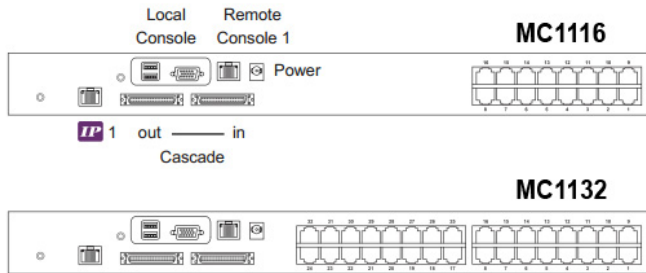

KVM SPECIFICATIONS

■ KVM Port	
Number of ports:	16 or 32
Connector:	RJ-45
Connectivity:	DVI-D / VGA connector dongle up to 40 meters (132 feet) via Cat6 / Cat5 cable
■ Local Console	
Monitor port:	DB15-pin VGA
Keyboard & mouse port:	2 x USB type connector for keyboard & mouse
Resolution support:	4:3 - max. 1600x1200 16:10 - max. 1440x900
■ Cat6 Remote Console	
Number of remote port:	1
Monitor port:	DB15-pin VGA
Keyboard & mouse port:	2 x USB type connector for keyboard & mouse
Remote I/O:	RJ45 via Cat5 / Cat5e / Cat6 cable up to 500 feet
Resolution support:	4:3 -max. 1600x1200 16:10-max. 1440x900
■ IP Remote Console	
Number of IP console:	1 for MC1116 / MC1132 2 for MC2116 / MC2132
User management:	15-user login, 1 x active user
Browser:	Internet Explorer, Firefox, Safari
Security:	SSL v3, RSA, AES, HTTP / HTTPS, CSR
IP Access:	RJ45 Ethernet per IP console
Resolution support:	4:3-max. 1600x1200

■ Expansion:	Up to 256 servers by 8-level cascade
■ Compatibility:	
Multi-platform:	Mix PCs, SUN and Mac G3 / G4 Mac / iMac
Support:	Windows 7 / Vista / 2003 / XP, Linux, Unix
■ Power	
Input:	AC power adapter
Consumption:	Max. 48 Watt, Standby 5 Watt
■ Regulatory :	
Safety:	cUL, FCC & CE certified
Environment:	RoHS2 & REACH compliant
■ Environmental	
Operating:	0 to 50°C
Storage:	-5 to 60°C
Relative humidity:	90%, non-condensing
Shock:	50G peak acceleration (11ms, half-sine)
Vibration:	58-100Hz / 0.98G (11ms / cycle)
■ Product Information	
Dimension (W x D x H):	443 x 171 x 44 mm / 17.4 x 6.7 x 1.73 inch
Net weight:	3 kg / 6.5 lb
■ Packing Information	
Dimension (W x D x H):	500 x400 x90 mm / 19.7 x 15.7x3.5 inch
Gross weight:	5 kg / 11 lb

KVM CASCADE

- Cascade up to 8 levels, 256 servers
- Cascading multiple KVM with CMC-8 cascade cable

