

NetView: 1U Rackmount 19" TFT 1280 x 1024 SUN LCD Keyboard/KVM Drawer with 104 key notepad keyboard w/ Touchpad (e), Integrated with Combo Cat6, 32 KVM Ports + 1 User Via CAT5 Extender + 0 Users Via KVM over IP. Over Depth is 25 Inch. Dongles sold separately

Model: SNK119CCE32e



FEATURES:

- 1U 19" LCD console drawer
- Direct Support for SUN Micro 1152 x 900 native resolution
- 104-key keyboard with SUN hotkeys
- Short depth design of 620mm(25 inch)Deep
- New enhanced aesthetics with molded front handle
- 2 post rack mounting available

SPECIFICATIONS:

LCD Panel	
Diagonal size	19" TFT
Max. Resolution	1280 x 1024 (Direct)
Brightness (cd/m2)	250
Backlight	CCF
Colors	16.7M
Contrast Ratio (typ)	1000 : 1
Viewing Angle (H/V)	160° x 160°
Active area (mm)	376 x 301
MTBF (hrs)	50,000
Casing Color	Black (RAL 9005)
Weight (Single console	
Net	12.7 kgs (27.9 lbs)
Gross	17.3 kgs (38.1 lbs)
Environmental	
Operating	0 to 50°C Degree
Storage	-5 to 60°C Degree
Relative humidity	5-90%, non-condensing
Shock	10G acceleration (11 ms duration)
Vibration	5-500Hz 1G RMS random vibration
Regulatory	cUL, FCC, CE
Power	
Input	Auto-sensing 100 to 240VAC, 50 / 60Hz
Consumption	Max. 48 Watt, Standby 5 Watt
Product Dimensions (Single console)	
Product	441.6 x 620 x 44 mm / 17.4 x 24.4 x 1.73 inch
Packing	590 x 823 x 140 mm / 23.2 x 32.4 x 5.5 inch

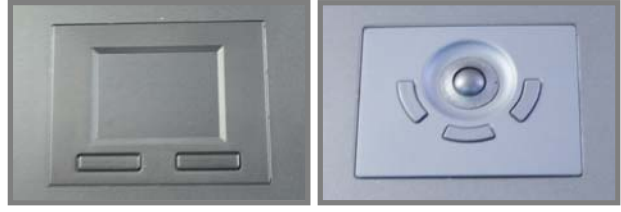

STRUCTURE DIAGRAM



- ① LCD interchangeable module kit
- ② Installation Slides
- ③ LCD membrane 
- ④ Membrane switch (KVM option)
- ⑤ Micro switch for screen auto power off
- ⑥ Keyboard interchangeable module kit
- ⑦ Mouse interchangeable module kit
- ⑧ Blue Power LED
- ⑨ Front USB port for device access (USB Hub KVM only)
- ⑩ Molded front handle

STANDARD KEYBOARD

e keyboard integrated with touchpad

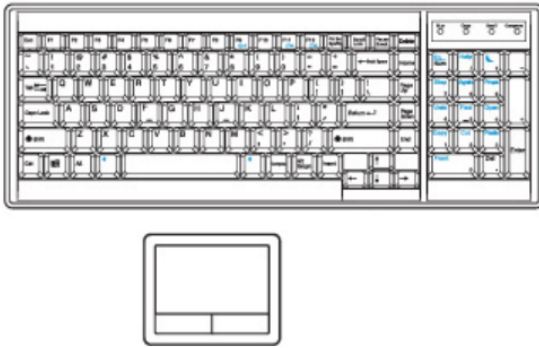

b keyboard integrated with trackball



America



United States

KVM PORT & CAT6 DONGLE CONNECTION

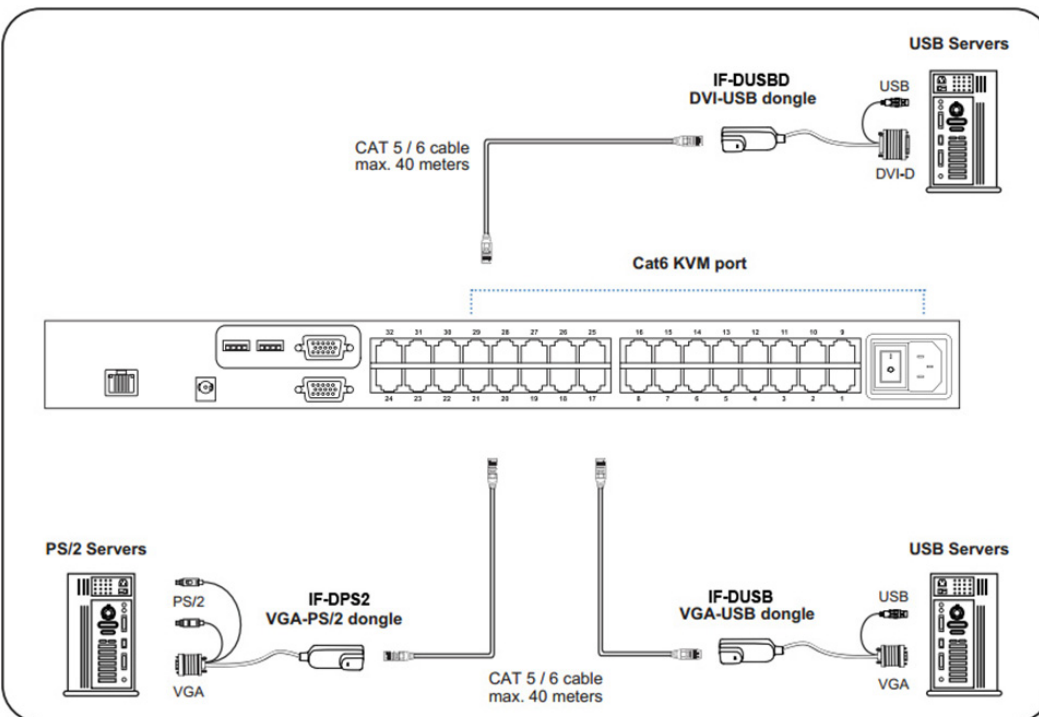

IF-DUSBD DVI-USB dongle

- To connect DVI-D connector to the computer's video card
- To connect USB connector to the computer's USB port



IF-DUSB VGA-USB dongle

- To connect DB-15 connector to the computer's video card
- To connect USB connector to the computer's USB port



IF-DPS2 VGA-PS/2 dongle

- To connect DB-15 connector to the computer's video card
- To connect PS/2 keyboard connector to the computer's keyboard port
- To connect PS/2 mouse connector to the computer's mouse port

Cat6 Dongle	EDID Resolution Hard-coded	Resolutions Capable			
		4:3			16:10
		1024 x 768	1280 x 1024	1600 x 1200	1440 x 900
IF-DPS2	1600 x 1200	✓	✓	✓	✓*
IF-DUSB	1600 x 1200	✓	✓	✓	✓*
IF-DUSBD	1280 x 1024	✓	✓	✗	✗

* Requires the user to enable showing unsupported resolutions via the target computer's video adapter settings (effectively ignoring the DDC / EDID)

REMOTE & LOCAL CONSOLE CONNECTION

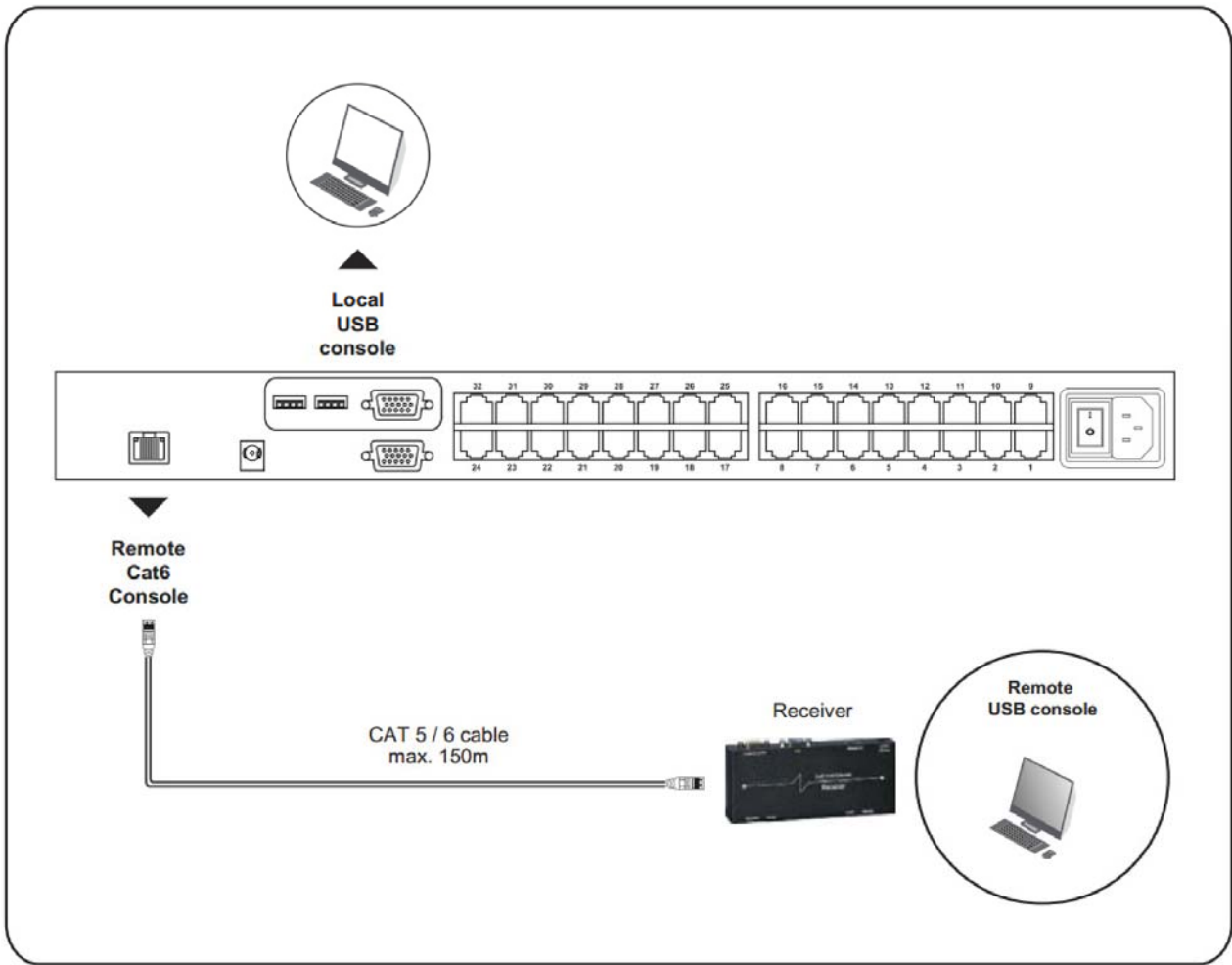

Combo Cat6 2-console KVM Benefits

- Combo Cat6 KVM with either 8, 16 or 32 ports in 1U
- Up to 40 meters between your servers & KVM ports
- Remote access up to 150 meters
- Cascade switches up to 8 levels & Mix switches between Cat6 & Combo DB-15 KVM
- Support DVI-USB, VGA-USB & VGA-PS/2 server interface
- Mix PS/2, USB & SUN with Multi-Platform switch capability

Switch Features & Options

- Multi lingual on screen display menu
- Advanced user profiles and configurable OSD hot key combinations
- Dual power with failover
- 12V, 24V and 48V DC Power options

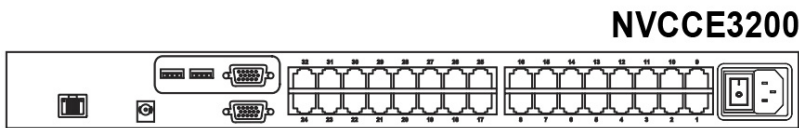
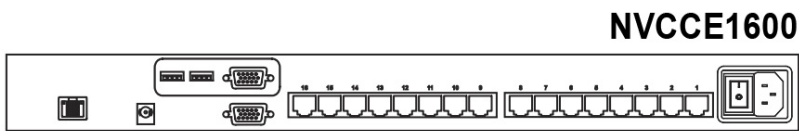
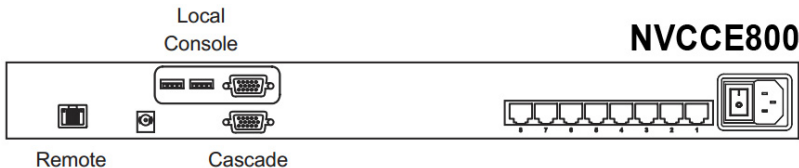

KVM SPECIFICATIONS

■ KVM Port	
Number of ports:	8, 16 or 32
Connector:	RJ-45
Connectivity:	DVI-D / VGA connector dongle up to 40 meters (132 feet) via Cat6 / Cat5 cable
■ Local Console	
Graphic Connector:	1 x DB-15 VGA
Resolution:	Up to 1600 x 1200
Input device:	2 x USB type A for keyboard & mouse
Remote I/O:	RJ45 via Cat5 / Cat5e / Cat6 cable up to 150m
Compensation:	Auto adjust for cable length
Resolution support:	4:3 - max. 1600 x 1200 16:10 - max. 1440 x 900
■ Expansion:	Up to 256 servers by 8-level cascade
■ Compatibility	
Multi-platform:	Mix PCs, SUN and Mac G3 / G4 Mac / iMac
Support:	Windows 7 / Vista / 2003 / XP, Linux, Unix
■ Power	
Input:	Auto sensing 100 to 240VAC, 50 / 60 Hz OR AC / DC power adapter 12V@3.3A (optional)
Option DC:	12V / 24V / 48V DC input
Consumption:	Max. 48 Watt, Standby 5 Watt

■ Regulatory :	
Safety:	cUL, FCC & CE certified
Environment:	RoHS2 & REACH compliant
■ Environmental	
Operating:	0 to 50°C
Storage:	-5 to 60°C
Relative humidity:	90%, non-condensing
Shock:	50G peak acceleration (11ms, half-sine wave)
Vibration:	58-100Hz / 0.98G (11ms / cycle)
■ Product Information	
Dimension (W x D x H):	443 x 171 x 44 mm / 17.4 x 6.7 x 1.73 inch
Net weight:	3 kg / 6.5 lb
■ Packing Information	
Dimension (W x D x H):	500 x 400 x 90 mm / 19.7 x 15.7 x 3.5 inch
Gross weight:	5 kg / 11 lb

KVM CASCADE

- Cascade up to 8 levels, 256 servers
- Cascading multiple KVM with CBC-6 cascade cable

