

Front IP65 Marine Bridge Display Monitor



Front IP65 15.6" Wide Marine Bridge Display Monitor 1366 x 768 220nits, HDMI, VGA, composite video, audio input, IEC60945 certificated Front hyper dimming knob control backlight brightness from nearly 0%-100% Internal Power Adapter , 100-240V AC Input+ PCT Touch Screen USB controller (Model: AMARW1560-PCT)

Features:

- Front hyper dimming knob control backlight brightness from nearly 0%-100%.
- Rugged construction, Front bezel NEMA4 / IP65 compliant.
- Front hardness glass protect screen (AR glass & touch for optional).
- Front osd control buttons to optimized display.
- Build in 2x 2watts stereo speakers.
- Support PIP & POP function.
- Standard with HDMI, VGA, Composite Video, Audio input.
- Panel (Flush) mount with clips.
- Meet standard VESA mount and optional robust mounting bracket.
- IEC60945 certificated

Specification:

TFT Characteristics	
Screen Size	15.6 inch wide TFT LCD
Backlight Type	LED
Resolution	1366x768
Contrast Ratio	400:1
Brightness (cd/m2)	220
View Angles (H/V)	90/50
Max. Color	262K
MTBF (Hrs.)	12,000
Input Signals:	
HDMI Signal	HDMI
VGA Signal	D-SUB 15P connector (Female)
Composite Video	RCA Phono plug
Audio	3.5" jack
AC Power Input	Standard IEC Inlet
DC Power Input (option)	Screw Terminal Block
Touch Screen (option)	USB-A or D-SUB 9P connector (Female)
RS-232 Remote (option)	D-SUB 9P connector (Female)
User Controls	
Power On/Off via front buttons	
VR Brightness Knob adjustment	
Power Mode Status LED indicator	
On Screen Display control(OSD)	
OSD Remote Control via RS-232 (option)	

Power Specifications	
AC Power Input	Standard IEC Type power cord with Internal Power Adapter , 100-240V AC Input
DC Power Input (option)	Screw Type Terminal Block with internal isolate DC 12V/24V/48V/125V power module
Mechanical and Environmental	
IP Protect	Front IP65 Grade
Mounting	Panel (Flush) Mount, VESA Mount, Robust Bracket, Sun-visor Bracket
Construction	Aluminum Front Bezel + Metal Housing
Operating Temperature	0 - 50 deg. C
Operating Humidity	5% - 95% (non -condensing)
Anti-Vibration	5 - 500 Hz / 1 Grms PTP
Anti-Shock	15G / Peak (11 ms)
Physical Dimension (WxHxD)	435 x 300 x 66mm
Packing Dimension (WxHxD)	570 x 430 x 220mm
Net Weight / Gross Weight	7 / 9 KGs
Certification and Approvals	CE / FCC / RoHs / IEC60945
Available Options	
Touch Screen	Resistive, Capacitive, SAW, IR Touch
AR Hardness Glass	3mm Anti-Reflective Protect Glass
DC Power	Isolate 12V/24V/48V/125V DC Power
SR-BKT	Stand & Roof Mounting Bracket
RT-BKT	Rotary Plate Robust Bracket
SV-BKT	Sun-Visor Bracket



Mechanical Drawing:

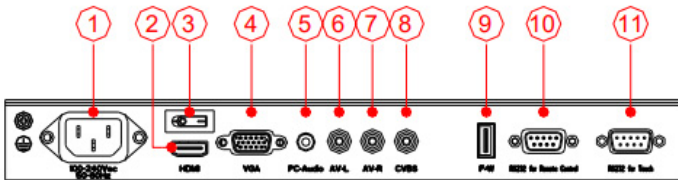
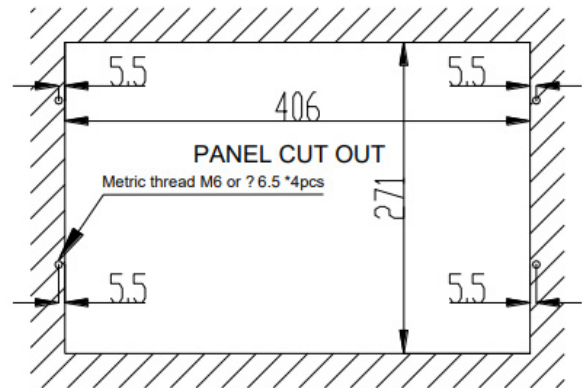
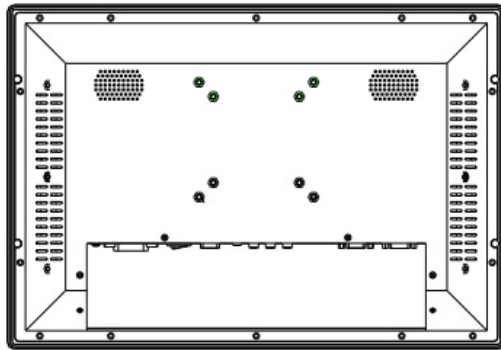
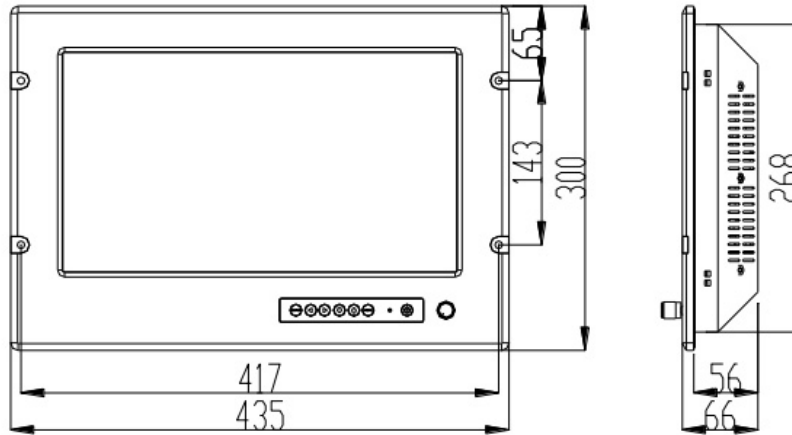

- | | |
|--------------|-------------------------------|
| 1 . AC Inlet | 7 . AV-R |
| 2 . HDMI | 8 . CVBS |
| 3 . Power sw | 9 . F/W |
| 4 . VGA | 10 . RS232 for Remote control |
| 5 . PC-Audio | 11 . RS232 for Touch |
| 6 . AV-L | |