

AODPC Series

Multi-Purpose & Water-Proof Panel PC

IP-65, 12.1" Multi-purpose &
Water-Proof Panel PC with Intel Celeron M Processor
Model: AODPC1210A1-CM6



Features

- Onboard Intel® Celeron® Low Power Processor
- 12.1" SVGA Color TFT LCD Display
- Water-Proof Sealing: IP-65 Certificated
- Sunlight-Viewable Display With Low Reflection
- Windows®2000, XP Pro, XP Embedded Support
- Day And Night Mode Display
- Ideal For Vehicle Application
- Supports Wireless LAN With Dual Internal (Optional)
- Water-Proof I/O Connector (IP-67 Rating)



Specifications

System	
Processor	Intel® Celeron® M 1.5 GHz/ 600 MHz
System Memory	DDR SODIMM x 1, Max. 1 GB
Storage Memory	Hard Disk Drive Bay/ CompactFlash™ (Internal slot)
LCD/CRT Controller	Intel® 852GM + Chrontel 7009
Ethernet	Intel® 82562, 10/100Base-TX, Water-proof RJ-45 x 1 (optional)
Expansion Slot	Mini PCI x 1 (Internal)
Water-Proof I/O Port	RS-232 (DB-9) x 1, RS-232/422/485 x 1, USB 2.0 x 2 Audio (Line-out) (optional)
Storage Disk	2.5" Hard Disk Drive Bay (Anti-vibration)/ CompactFlash™ slot (Internal)
OS Support	Windows® 2000, Windows® XP, Windows® XP Embedded
Mechanical	
Construction	Sealed Aluminum Alloy Chassis
Color	Silver Gray
Mounting	VESA 75/100mm
Dimension	13.58" x 11.1" x 2.36" (345mm x 282mm x 60mm)
Gross Weight	12.1 lb (5.5 kg)
Net Weight	9.9 lb (4.5 kg)
Environmental	
Operating Temperature	-4°F ~ 122°F (-20°C ~ 50°C)
Storage Temperature	-22°F ~ 158°F (-30°C ~ 70°C)
Storage Humidity	10 ~90%@35°C, non-condensing
Vibration	3G Random Operation, 5~500Hz
Shock	15G peak acceleration (11m sec. duration) / operation
Safety	IP-65 Certified
EMC	CE/FCC Class A
Power Supply	
DC-DC Input, 90W	Input Range: 9V ~ 30V DC
LCD	
Display Type	12.1" TFT- LCD
Max. Resolution	800 x 600
Max. Color	262K colors
Dot Size	0.3075 x 0.3075
Luminance (Typical)	450 cd/m2
View Angle	140°(H)/110°(V)
Back Light MTBF (Hours)	50,000

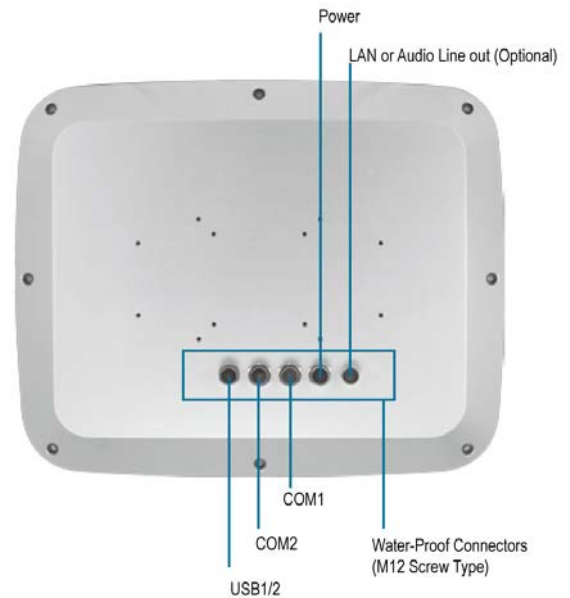

Touchscreen	
Type	8-wire, Analog Resistive, Low Reflection (FOX-120STT) 5-wire, Analog Resistive (FOX-120HTT)
Resolution	2048 x 2048
Light Transmission	> 76% (8-wire analog resistive) > 80% (5-wire analog resistive)
Lifetime	2 million activations (8-wire analog resistive) 35 million activations (5-wire analog resistive)



Dimensions

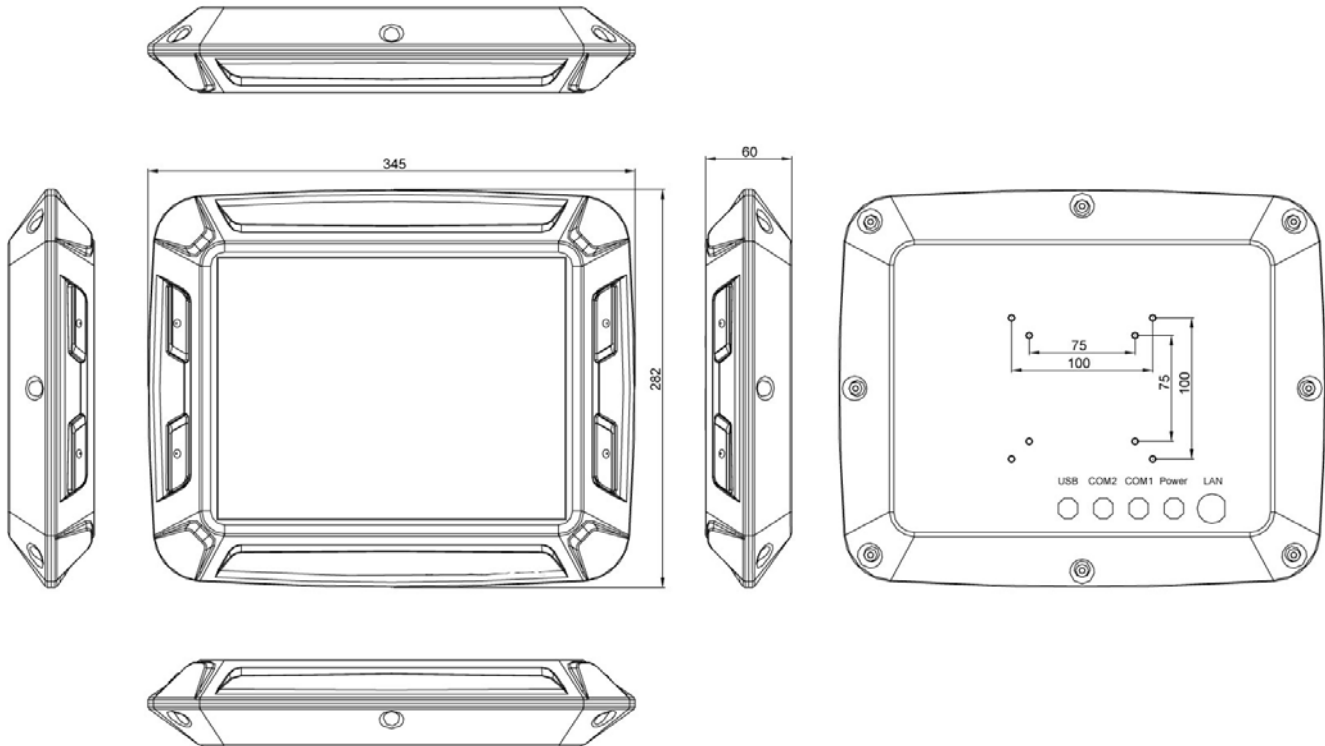

Optional Accessories

- **9761F15000**
Wireless LAN kits with Internal Antenna
- **1757910004**
AC Adapter (100W)
- **968C016G06**
16 GB Wide Temperature CompactFlash™
Disk Drive
- **1702031802**
Power Cord (US Type)
- **1702031803**
Power Cord (European Type)
- **170203180E**
Power Cord (Japanese Type)
- **9783204012**
2.5" 40 GB Automotive Hard Disk Drive
- **968C204859**
2 GB Wide Temperature CompactFlash™ Drive
- **968C409654**
4 GB Wide Temperature CompactFlash™ Drive
- **968C819215**
8 GB Wide Temperature CompactFlash™ Disk Drive
- **STAND-FOXS0**
Desktop Stand