

8U Rackmount LCD Monitor

8U 17" LCD Rack Mount Industrial Monitor
DVI-D, VGA, audio input 2x 2watts stereo speakers

Model: ANP817

FEATURES:

- Compact 19 inch rack mountable with 8U height
- 17" LCD Panel, support 1280 x 1024 resolution
- DVI-D, VGA, Audio input
- 90 °tilt adjustment while mounted in rack: 45° ~ -45° (V)
- Heavy duty steel chassis with hardness glass protect screen
- Front OSD control buttons to optimized display
- Build in 2x 2watts stereo speakers

OPTION:

- Composite video input
- HDMI or Display port input
- 3G / HD / SD-SDI broadcast grade input
- DC 9~36 V power input
- AR Hardness glass
- Touch screen

SPECIFICATIONS

LCD CHARACTERISTICS	
Screen Size	17 inch
Backlight Type	LED
Resolution	1280 x 1024
Contrast Ratio	1000:1
Brightness (cd/m2)	250
View Angles (H/V)	170/178
Pixel Size (HxV) mm	0.264x0.264
Max. Color	16.7M
MTBF (Hrs.)	50,000

INPUT SIGNALS	
DVI-D	DVI-D 24Pin Connector (Female)
VGA	D-SUB 15Pin Connector (Female)
Audio	3.5" Jack
Power Input	Standard IEC Inlet
Touch-USB (option)	USB A Type connector
Touch-RS232 (option)	D-SUB 9P connector (Female)

POWER SPECIFICATIONS	
AC Power Input	Standard IEC Type Power Cord with Internal Power adapter, 100-240V AC Input
Wide Range DC PowerInput (option)	Screw Type Terminal Block with internal wide Range DC 9-36V power module

USER CONTROL INTERFACE	
Power ON / OFF via Front Button	
Power Mode Status LED indicator	
OSD (On Screen Display) Buttons	

MECHANICAL AND ENVIRONMENT	
Height	8U
IP Protect	N/A
Mounting	VESA Mount and Rack Mount
Construction	Metal Housing
Operating Temperature	0 - 50 deg. C
Operating Humidity	5% - 95% (non -condensing)
Anti-Vibration	5 - 500 Hz / 1 Grms PTP
Anti-Shock	15G / Peak (11 ms)
Physical Dimension (WxHxD)	482 x 355x 62 (mm)
Packing Dimension (WxHxD)	620 x 480 x 210 (mm)
Net Weight / Gross Weight	9.5 / 12 (KGs)
Certification and Approvals	CE / FCC / RoHS

DRAWINGS

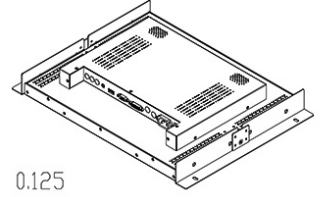
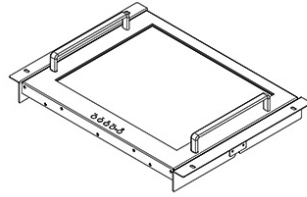
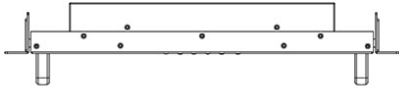

Ratio 0.125

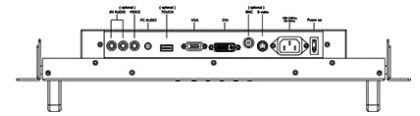
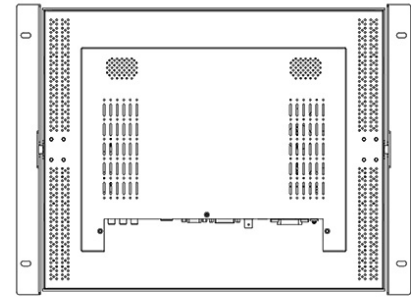
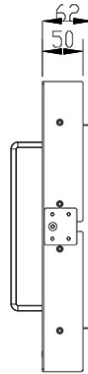
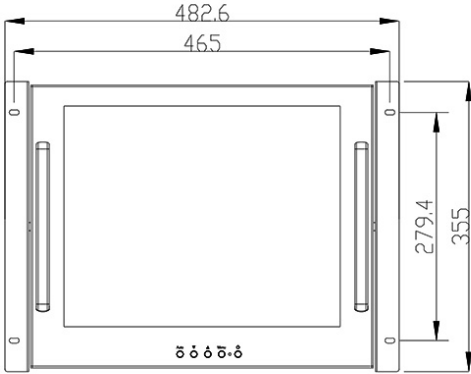
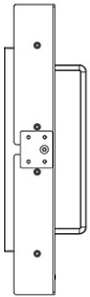

INSTALLATION GUIDE

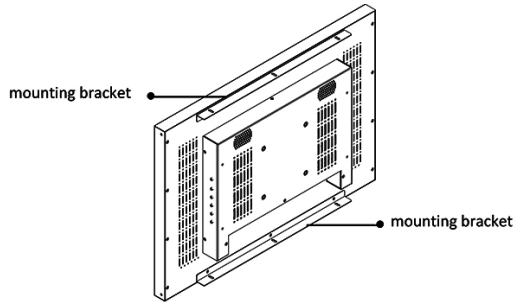

Step 1

- Screw 2 x mounting bracket on the LCD panel

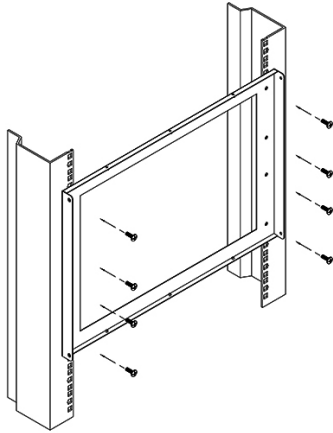

step 2

- mount the rear bracket with M6 screw set.
- 8 x M6 screw set are required
- **M6 screw sets are not provided**

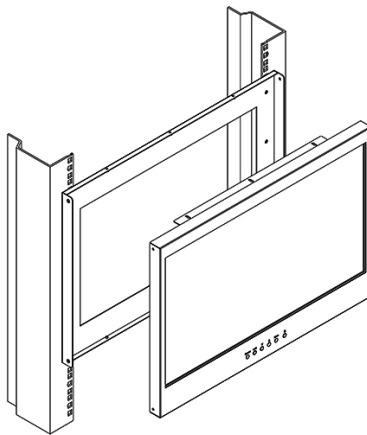

step 3

- Insert the display panel into the rear bracket.

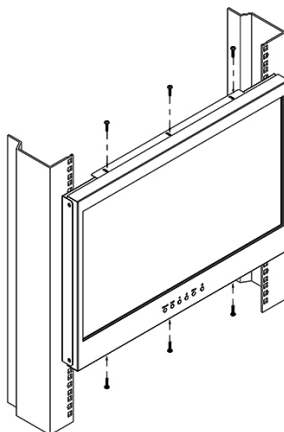

step 4

- Fix the display panel into the rear bracket with 6 x screws

DISPLAY PRESENT ON DIFFERENT SOLUTION

Resolution 1920 x 1200

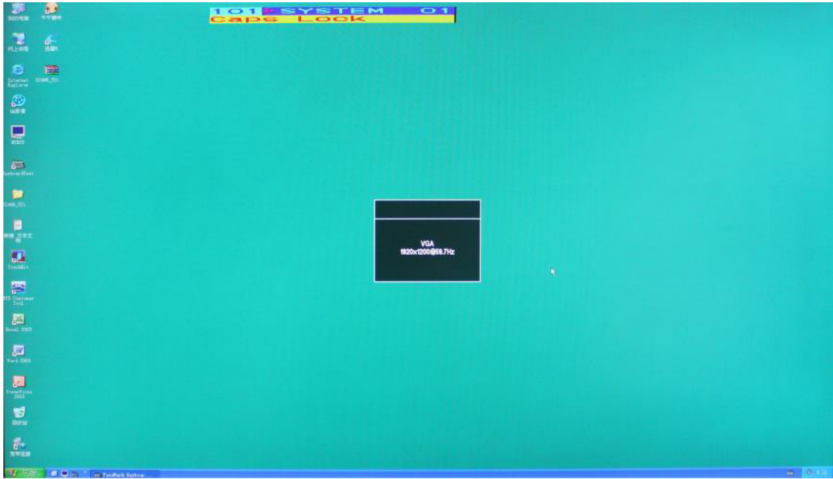

Resolution 1920 x 1080

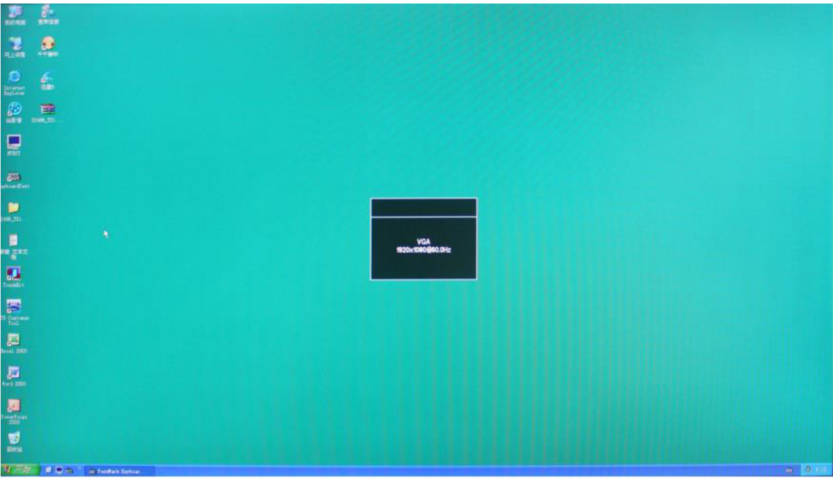

Resolution 1600 x 1200

