



Avocent.

EVR1500

Installer/User Guide



**INSTRUCTIONS**

This symbol is intended to alert the user to the presence of important operating and maintenance (servicing) instructions in the literature accompanying the appliance.

**DANGEROUS VOLTAGE**

This symbol is intended to alert the user to the presence of uninsulated dangerous voltage within the product's enclosure that may be of sufficient magnitude to constitute a risk of electric shock to persons.

**PROTECTIVE GROUNDING TERMINAL**

This symbol indicates a terminal which must be connected to earth ground prior to making any other connections to the equipment.



• **EVR1500**

Installer/User Guide

Avocent, the Avocent logo, The Power of Being There and DSVIEW are registered trademarks of Avocent Corporation. All other marks are the property of their respective owners.

© 2004 Avocent Corporation. All rights reserved.

USA Notification

Warning: Changes or modifications to this unit not expressly approved by the party responsible for compliance could void the user's authority to operate the equipment.

Note: This equipment has been tested and found to comply with the limits for a Class A digital device, pursuant to Part 15 of the FCC Rules. These limits are designed to provide reasonable protection against harmful interference when the equipment is operated in a commercial environment. This equipment generates, uses and can radiate radio frequency energy and, if not installed and used in accordance with the instruction manual, may cause harmful interference to radio communications. Operation of this equipment in a residential area is likely to cause harmful interference in which case the user will be required to correct the interference at his own expense.

Canadian Notification

This Class A digital apparatus complies with Canadian ICES-003.

Cet appareil numérique de la classe A est conforme à la norme NMB-003 du Canada.

Japanese Approvals

この装置は、情報処理装置等電波障害自主規制協議会（VCCI）の基準に基づくクラスA情報技術装置です。この装置を家庭環境で使用すると電波妨害を引き起こすことがあります。この場合には使用者が適切な対策を講ずるよう要求されることがあります。

Safety and EMC Standards

USA (UL, FCC)
Canada (cUL)
European Union (CE)
Japan (VCCI)
Australia (C-tick)

Table of Contents

Chapter 1: Product Overview

<i>Features and Benefits</i>	3
<i>Typical Configuration</i>	4
<i>Safety Precautions</i>	5

Chapter 2: Installation

<i>Getting Started</i>	9
<i>Mounting the EVR1500 Environmental Monitor Appliance</i>	11
<i>Installing the EVR1500 Environmental Monitor Appliance</i>	12
<i>Configuring the EVR1500 Environmental Monitor Appliance</i>	13

Chapter 3: Basic Operations

<i>Launching the Web Browser GUI</i>	19
<i>Launching Through DSView Software</i>	20
<i>Configuring the Network</i>	21
<i>Configuring the Email Server</i>	23
<i>Setting the Clock</i>	24
<i>Changing the Login Password</i>	25
<i>Configuring Digital Inputs</i>	26
<i>Configuring Analog Inputs and Internal Sensors</i>	27
<i>Configuring Digital Outputs</i>	29
<i>Configuring Calculations</i>	31
<i>Configuring XML Reports</i>	33
<i>Configuring Delimited Reports</i>	35
<i>Configuring User Reports</i>	36
<i>Configuring Email Actions</i>	38
<i>Configuring SNMP Traps</i>	40
<i>Configuring FTP Actions</i>	42
<i>Configuring Combination Actions</i>	44
<i>Configuring Output Actions</i>	46
<i>Configuring Report To File Actions</i>	47
<i>Viewing Logs</i>	49

Chapter 4: Advanced Operations

<i>Setting Thresholds</i>	53
<i>Configuring Rules</i>	55
<i>Configuring Timed Rules</i>	57
<i>Configuring User Security</i>	58

Table of Contents (Continued)

Appendices

<i>Appendix A: Application Updates</i>	63
<i>Appendix B: Technical Specifications</i>	65
<i>Appendix C: EVR1500 Environmental Monitor Appliance Pinouts</i> ..	67
<i>Appendix D: SNMP Trap MIB</i>	70
<i>Appendix E: Customer-Supplied Sensors</i>	72
<i>Appendix F: Technical Support</i>	73



1

Product Overview

- ***Contents***

<i>Features and Benefits</i>	3
<i>Typical Configuration</i>	4
<i>Safety Precautions</i>	5

Chapter 1: Product Overview

Features and Benefits

The Avocent EVR1500 environmental monitor and control appliance manages environmental conditions within a rack and/or data center through a standard web browser or the Avocent DSView® software. By combining analog and digital technology, the EVR1500 environmental monitor appliance collects data from internal and external sensors, compares it to pre-configured parameters, issues alarms, generates reports and acts on conditions and events. Multiple users can access the appliance locally or remotely.

Access via network connection

Users can access the EVR1500 environmental monitor appliance remotely over Ethernet from a web browser or a PC running DSView software. User PCs can be located anywhere a valid network connection exists. No special software or drivers are required on the attached, or host, computers. The EVR1500 environmental monitor appliance can be configured on a separate network from your data network, allowing you to view and report your environmental conditions even if your applications network is down. This feature is important because loss of access to the data network could be due to adverse environmental or security conditions.

Web-based GUI

The EVR1500 environmental monitor appliance provides an easy-to-use web-based GUI (Graphical User Interface) that enables you to configure the network, digital and analog sensors, thresholds and alarm reports. The software is a Java™ applet uploaded from the EVR1500 environmental monitor appliance to a computer.

User-configurable environmental conditions

Environmental thresholds set through the web GUI trigger alarms that can be automatically reported on the application screen, emailed, sent to a pager or sent to an NMS (Network Management System) using SNMP (Simple Network Management Protocol).

Internal and external sensors

The EVR1500 environmental monitor appliance provides four internal sensors: Temperature, Humidity, Air Flow and Audio. The EVR1500 environmental monitor appliance also supports up to eight external analog sensors, six external digital sensors and two digital outputs. The external sensors enable you to monitor precise locations within the rack or data center. See Figure 1.1 and the EVR1500 Environmental Monitor Appliance Features table for details.

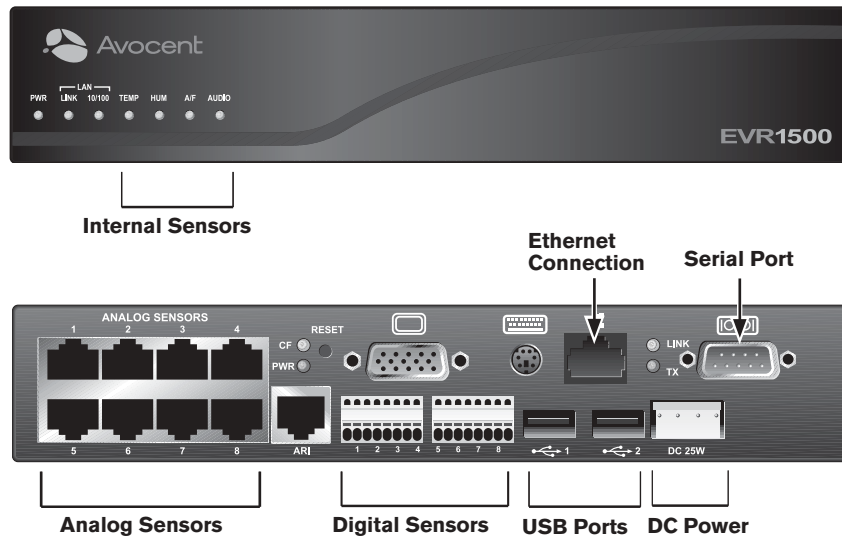

Figure 1.1: EVR1500 Environmental Monitor Appliance Front and Back Panel

EVR1500 Environmental Monitor Appliance Features

Feature	Description
Internal Sensors	Four internal sensors (Temperature, Humidity, Air Flow, Audio)
Analog Sensors	Eight inputs (RJ-45) with 12 VDC (Volts DC) powering
Digital Sensor Inputs	Six, plug-in modules 1 to 6
Digital Sensor Outputs	Two, plug-in modules 7 and 8
USB port 1	Reserved for future use
USB port 2	Reserved for future use
Serial port	Used for configuration
DC power connection	For power supply (provided by Avocent)
ARI port	Not in use
KVM console	Not in use

Typical Configuration

Shown in Figure 1.2, a typical configuration consists of the EVR1500 environmental monitor appliance, a serial connection for setup, an Ethernet connection and a PC running Microsoft® Internet Explorer (IE) or Avocent DSView software.

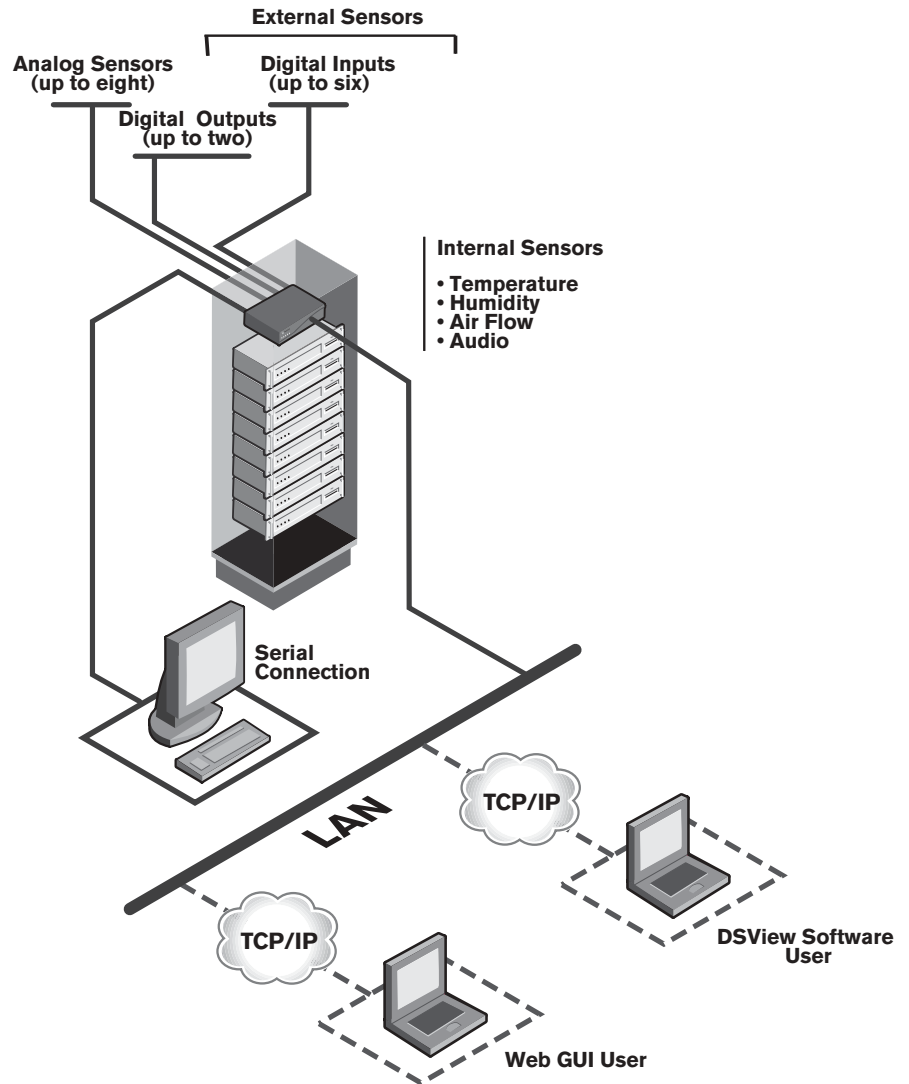

Figure 1.2: Typical EVR1500 Environmental Monitor Appliance Configuration

Safety Precautions

To avoid potential problems when using Avocent products, use only DC power supplied by Avocent.



CAUTION: The EVR1500 environmental monitor appliance contains an internal battery that is used for the real time clock. This battery is not a field replaceable item, and replacement should not be attempted by a user. If real time clock errors occur and the battery is suspected, visit the Avocent web site at <http://www.avocent.com/support> or contact Avocent Technical Support at (888) 793-8763.

NOTE: The AC power cord is the main disconnect.

Rack and wall mount safety considerations

- **Elevated Ambient Temperature:** If installed in a closed rack assembly, the operation temperature of the rack environment may be greater than room ambient. Use care not to exceed the rated maximum ambient temperature of the appliance.
- **Reduced Air Flow:** Installation of the equipment in a rack should be such that the amount of airflow required for safe operation of the equipment is not compromised.
- **Mechanical Loading:** Mounting of the equipment in the rack should be such that a hazardous condition is not achieved due to uneven mechanical loading.
- **Circuit Overloading:** Consideration should be given to the connection of the equipment to the supply circuit and the effect that overloading of circuits might have on overcurrent protection and supply wiring. Consider equipment nameplate ratings for maximum current.
- **Reliable Earthing:** Reliable earthing of rack mounted equipment should be maintained. Pay particular attention to supply connections other than direct connections to the branch circuit (for example, use of power strips).



2

Installation

- *Contents*

- Getting Started 9*
- Mounting the EVR1500 Environmental Monitor Appliance 11*
- Installing the EVR1500 Environmental Monitor Appliance 12*
- Configuring the EVR1500 Environmental Monitor Appliance 13*

Chapter 2: Installation

Getting Started

Before installing your EVR1500 environmental monitor appliance, refer to the following lists to ensure that you have all the items that shipped with the appliance as well as other items necessary for proper installation.

Supplied with the EVR1500 environmental monitor appliance

The following items are supplied with the EVR1500 environmental monitor appliance:

- EVR1500 environmental monitor appliance
- One DC power supply
- One serial null modem cable (Avocent part number 042-0063)
- Wall mounting brackets and screws
- EVR1500 Installer/User Guide
- EVR1500 Quick Installation Guide

Additional items needed

For the mount shelf rack option, order the 1U Mount Shelf Rack kit (Avocent part number 790200).

Hardware requirements

The following hardware requirements are necessary for a PC connecting to the EVR1500 environmental monitor appliance:

- 300 MHz processor
- 128 Mb or more of DRAM (Dynamic Random Access Memory)

Software requirements

The following software requirements are necessary for a PC connecting to the EVR1500 environmental monitor appliance:

- Microsoft® Windows® 2000 Professional SP3 or Microsoft Windows XP Professional SP1a
- J2SE™ Runtime Environment 1.4.2 or later
- Microsoft Internet Explorer (IE) 5.5 SP2 or IE 6 SP1



NOTE: You can download the J2SE Runtime Environment from the Sun Microsystems™ web site by typing <http://java.sun.com/j2se/downloads.html> in the web browser address bar. If you do not have the J2SE Runtime Environment installed on your PC when you first connect to the EVR1500 environmental monitor appliance with a web browser, the appliance will redirect your browser to the java.sun.com web site so that you can download and install the correct J2SE Runtime Environment files on your PC.

CAUTION: Downloading the newest version of Java J2SE may affect other Java-accessible devices. If devices are affected, check them for the most recent version of code.

Verification of Ethernet and sensor conditions

The LEDs on the front and back panels of the EVR1500 environmental monitor appliance show the status of the appliance and the Ethernet connection. LEDs on the front panel also indicate the status of the internal sensors. Refer to the following table for descriptions of the LEDs on the EVR1500 environmental monitor appliance.

Front Panel LEDs

LED Label	Color	Description
PWR	Green	When illuminated, indicates the appliance is powered.
LINK	Green	When illuminated, indicates an active connection to the network.
10/100	Amber	When illuminated, indicates communication at the 100 Mb rate. When not illuminated, indicates 10 Mb rate.
TEMP	Green Red	When illuminated green, temperature is normal. When illuminated red, temperature is over/under threshold.
HUM	Green Red	When illuminated green, humidity is normal. When illuminated red, humidity is over/under threshold.
A/F (Air Flow)	Green Red	When illuminated green, air flow is normal. When illuminated red, air flow is over/under threshold.
AUDIO	Green Red	When illuminated green, audio is normal. When illuminated red, audio is over/under threshold.

NOTE: TEMP, HUM, A/F and AUDIO LEDs are controlled by the GUI configuration for each specific sensor.

Back Panel LEDs

LED Label	Color	Description
CF (Compact FLASH)	Amber	Blinks to indicate activity to the Compact FLASH
PWR	Green	Illuminates to indicate the appliance is powered
LINK	Green	Illuminates to indicate an active connection to the network
TX	Amber	Blinks to indicate network activity

Mounting the EVR1500 Environmental Monitor Appliance

You can wall mount your EVR1500 environmental monitor appliance using the supplied wall mounting kit. You also can rack mount your appliance on a standard shelf or the 1U Rack Mount Shelf (supplied separately; Avocent part number 790200) using the instructions provided with the kit. See Figure 2.1 for the wall mounting option.



Figure 2.1: EVR1500 Environmental Monitor Appliance Wall Mounting Diagram

To wall mount the environmental monitor appliance:

1. Using the screws supplied with the wall mounting brackets, place the brackets on the EVR1500 environmental monitor appliance.
2. While holding the appliance in the preferred mounting position, mark the holes needed for the wall plugs.

NOTE: For proper operation of the internal sensors, mount the EVR1500 environmental monitor appliance with the Avocent logo in the "up" position, as shown in Figure 2.1.

3. Install the wall plugs.
4. Install the EVR1500 environmental monitor appliance and fasten the screws to hold the appliance in place.

Installing the EVR1500 Environmental Monitor Appliance

Figure 2.2 illustrates one possible configuration for your EVR1500 environmental monitor appliance. Follow the detailed set of procedures following Figure 2.2 to successfully install the appliance.

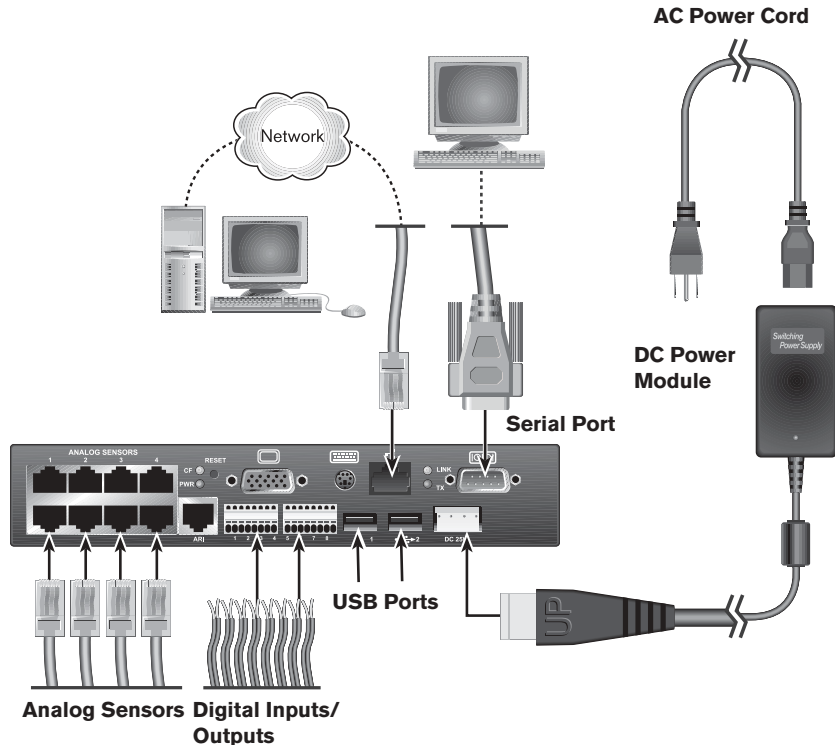

Figure 2.2: Basic EVR1500 Environmental Monitor Appliance Configuration



WARNING: To reduce the risk of electric shock or damage to your equipment-

- Plug the power cord into a grounded (earthed) outlet that is easily accessible at all times.
- Disconnect the power from the appliance by unplugging the power cord from either the electrical outlet or the DC power supply.

To install the EVR1500 environmental monitor appliance:

1. Using an Unshielded Twisted Pair (UTP) CAT 5 cable, connect the network port on the back of the EVR1500 environmental monitor appliance to your LAN.
2. On the back of the appliance, under Analog Sensors, insert sensor cables supplied by Avocent or a third party into any of the RJ-45 ports. Place the sensor in the desired location. See *Appendix C* for pinout information.

3. On the back of the EVR1500 environmental monitor appliance, insert into plug-in modules 1 to 6, 2-wire digital sensors supplied by Avocent or a third party. Place the sensor in the desired location. See *Appendix C* for pinout information.

NOTE: Plug-in modules 7 and 8 are digital output ports.

4. With the small white ridge of the power connector facing up, plug the supplied power cord into the back of the EVR1500 environmental monitor appliance. Connect the appliance by plugging one end of the AC power cord into the switching power supply. Plug the other end of the power cord into the appropriate AC power source.
5. When power is applied, the appliance performs a boot sequence for approximately 60 seconds. After the boot sequence is complete, press the **Enter** key to display the login prompt on the Terminal screen. To manually set the IP address follow the instructions in the next section, *Configuring the EVR1500 Environmental Monitor Appliance*.

NOTE: The EVR1500 environmental monitor appliance is factory configured to use the DHCP (Dynamic Host Configuration Protocol) to obtain an IP address from the network. If your appliance does not have a MAC address on the bottom of the appliance, you can obtain a MAC address from the CLI (Command Line Interface) using the **ifconfig** command as shown in Figure 2.3.

6. Using Internet Explorer, launch the web GUI by typing the IP address configured in the *Configuring the EVR1500 Environmental Monitor Appliance* section.

NOTE: You can download this application from the Sun Microsystems web site by typing <http://java.sun.com/j2se/downloads.html> in the web browser address bar. Once the IP address has been set through the Terminal screen, changes to the IP address can be made through the web GUI. Refer to *Configuring the Network* in Chapter 3 for instructions.

7. Finally, configure the sensors. Refer to Chapter 3 for instructions on configuring the sensors.

Configuring the EVR1500 Environmental Monitor Appliance

The initial configuration of the EVR1500 environmental monitor appliance must be performed using terminal emulation software (such as HyperTerminal®). After the initial configuration, you can make changes through a terminal connection or through the web GUI. See *Configuring the Network* in Chapter 3 for instructions on configuring the EVR1500 environmental monitor appliance through the web GUI.

To use a terminal or terminal emulation program:

1. After mounting the appliance, connect a terminal or PC running terminal emulation software to the serial port on the back panel of the EVR1500 environmental monitor appliance using the supplied null modem cable. Configure your terminal or terminal emulation program as follows:

Baud rate	38.4K
Bits per character	8 bits
Parity	None
Stop bits	1 stop bit
Flow control	None

2. On the Terminal screen, enter **root** as the default username and **root** as the default password.
5. Verify the current IP address by entering **ifconfig**. As shown in Figure 2.5, the following default IP parameters display:
[IP ADDRESS] [NETMASK] [GATEWAY]

```

[root@EVR1500 root]$ifconfig
eth0      Link encap:Ethernet  HWaddr 00:0B:AB:00:F7:71
          inet addr:192.168.1.53  Bcast:192.168.1.255  Mask:255.255.255.0
          UP BROADCAST RUNNING MULTICAST  MTU:1500  Metric:1
          RX packets:0 errors:0 dropped:0 overruns:0 frame:0
          TX packets:0 errors:0 dropped:0 overruns:0 carrier:0
          collisions:0 txqueuelen:100
          RX bytes:0 (0.0 iB)  TX bytes:0 (0.0 iB)
          Interrupt:10 Base address:0x5000

lo        Link encap:Local Loopback
          inet addr:127.0.0.1  Mask:255.0.0.0
          UP LOOPBACK RUNNING  MTU:16436  Metric:1
          RX packets:314 errors:0 dropped:0 overruns:0 frame:0
          TX packets:314 errors:0 dropped:0 overruns:0 carrier:0
          collisions:0 txqueuelen:0
          RX bytes:46753 (45.6 kiB)  TX bytes:46753 (45.6 kiB)

[root@EVR1500 root]$

```

Figure 2.3: IP Parameter Summary

4. If you wish to change the IP address, enter **setip** on the Terminal screen. The following setup options display, as shown in Figure 2.4:
setip DHCP
setip IP ipaddress netmask [gateway]

NOTE: Using DHCP enables you to obtain IP address and network configuration. Gateway is in brackets on the screen because it is optional.

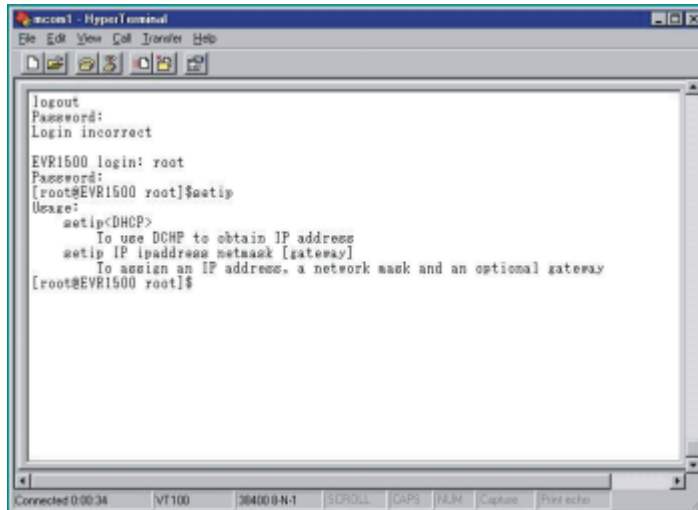

```
logout
Password:
Login incorrect
EVR1500 login: root
Password:
[root@EVR1500 root]#setip
Usage:
  setip<DHCP>
    To use DHCP to obtain IP address
  setip IP ipaddress netmask [gateway]
    To assign an IP address, a network mask and an optional gateway
[root@EVR1500 root]#
```

Figure 2.4: IP Parameter Setup

5. Obtain the IP address through DHCP by entering **setip DHCP**.
- or -
Enter static IP parameters, using the following as an example:
setip IP 192.168.1.53 (space) 255.255.255.0 (space) 192.168.1.1

NOTE: For the DHCP server reservation, locate the MAC address on the bottom of the EVR1500 environmental monitor appliance or on the IP Parameter Summary window displayed as HWaddr in Figure 2.3.

6. Reboot the EVR1500 environmental monitor appliance by entering **reboot** on the Terminal screen.
7. After you have rebooted the appliance, at the login prompt, enter **root** as the username and **root** as the password.
8. Verify the new IP parameters by entering **ifconfig**. The IP parameters are displayed as shown in Figure 2.3.
9. Log out of the Terminal screen by entering **logout**.



3

Basic Operations

- *Contents*

<i>Launching the Web Browser GUI</i>	19
<i>Launching Through DSView Software</i>	20
<i>Configuring the Network</i>	21
<i>Configuring the Email Server</i>	23
<i>Setting the Clock</i>	24
<i>Changing the Login Password</i>	25
<i>Configuring Digital Inputs</i>	26
<i>Configuring Analog Inputs and Internal Sensors</i>	27
<i>Configuring Digital Outputs</i>	29
<i>Configuring Calculations</i>	31
<i>Configuring XML Reports</i>	33
<i>Configuring Delimited Reports</i>	35
<i>Configuring User Reports</i>	36
<i>Configuring Email Actions</i>	38
<i>Configuring SNMP Traps</i>	40
<i>Configuring FTP Actions</i>	42
<i>Configuring Combination Actions</i>	44
<i>Configuring Output Actions</i>	46
<i>Configuring Report To File Actions</i>	47
<i>Viewing Logs</i>	49

Chapter 3: Basic Operations

The operating platform for the EVR1500 environmental monitor appliance uses the Linux® 2.4 kernel and is configured through a web browser application. The web application requires the Java J2SE Runtime Environment (1.4.2 or later) for system configuration, application setup and data presentation. The Java applet is installed on your PC from the EVR1500 environmental monitor appliance when you type the appropriate URL in the web browser address field.

Launching the Web Browser GUI

After you have installed the EVR1500 environmental monitor appliance, you are ready to launch the web application's GUI. The web GUI provides you with easy-to-navigate screens for configuring the network, sensor inputs /outputs (I/O) and actions (such as email) that will perform alarm reporting.

To launch the web GUI:

1. If the J2SE Runtime Environment (1.4.2 or later) is not running on your computer, load the applet from the Sun Microsystems web site by typing the following URL in the web browser address bar:
<http://java.sun.com/J2se/downloads.html>
2. From the Sun Microsystems web page, download the J2SE Runtime Environment (1.4.2 or later). Once the file is downloaded, install it on your computer and reboot.
3. Launch Internet Explorer and type the appropriate URL in the web browser address field. (For example, if your EVR1500 environmental monitor appliance has the IP address 192.168.1.53, type **<http://192.168.1.53>** in the web browser address field.) This action loads the Java applet. The Login window displays.



Figure 3.1: Login Window

4. Type **admin** in the User Name field.
5. Type **password** in the Password field. Click **OK**.

NOTE: A password can be changed by selecting the *User* or *System* tab from the web GUI and typing a new password in the Password field.

- The Main tab window displays a summary of all enabled digital and analog I/Os in addition to calculation values. This window also displays general system information.

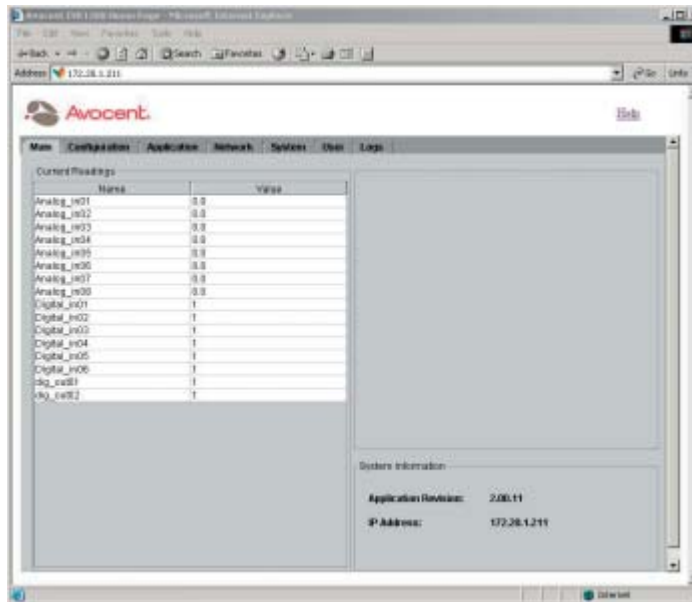

Figure 3.2: Main Tab

Launching Through DSView Software

You can launch the EVR1500 environmental monitor appliance through the Avocent DSView software if you are running the application on your system and the EVR1500 environmental monitor appliance has been added through the DSAdmin management application. For more information on adding and viewing the EVR1500 environmental monitor appliance through the DSView software (2.1 or later), refer to the DSView Installer/User Guide.

To launch through DSView software:

- Add the EVR1500 environmental monitor appliance using the DSAdmin management application.
- Launch the DSView software. The DSView software window displays.

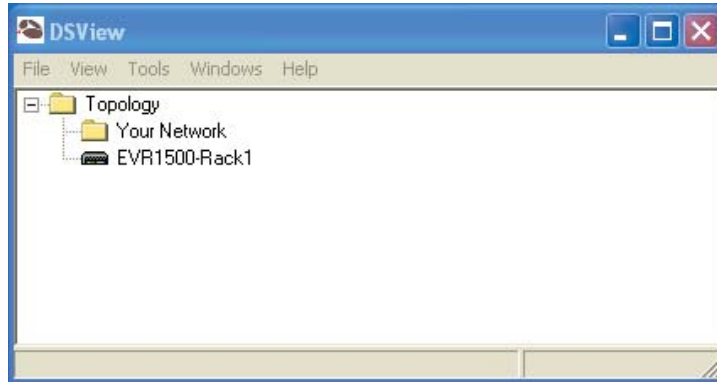

Figure 3.3: DSView Software Window

3. Double-click the *Topology* icon. The EVR1500 environmental monitor appliance icon displays.
4. Double-click the EVR1500 environmental monitor appliance icon. Internet Explorer is launched and the Login window displays. This action loads the Java applet.



Figure 3.4: Login Window

5. Type **admin** in the User Name field.
6. Type **password** in the Password field. Click *OK*.

Configuring the Network

You can configure the network and set parameters for the SMTP (Simple Mail Transfer Protocol) email server through the web GUI Network tab. If you have already configured your network through HyperTerminal, the values will be automatically populated; you can bypass the following steps provided and proceed to *Configuring the Email Server*.

To configure the network:

1. After launching the web GUI, click *Network - Fixed Network*. The Fixed Network Preferences window displays a list of configuration items for the Ethernet. Your IP address and network settings will display. If you have an IP address assigned by DHCP, only the IP address will display.

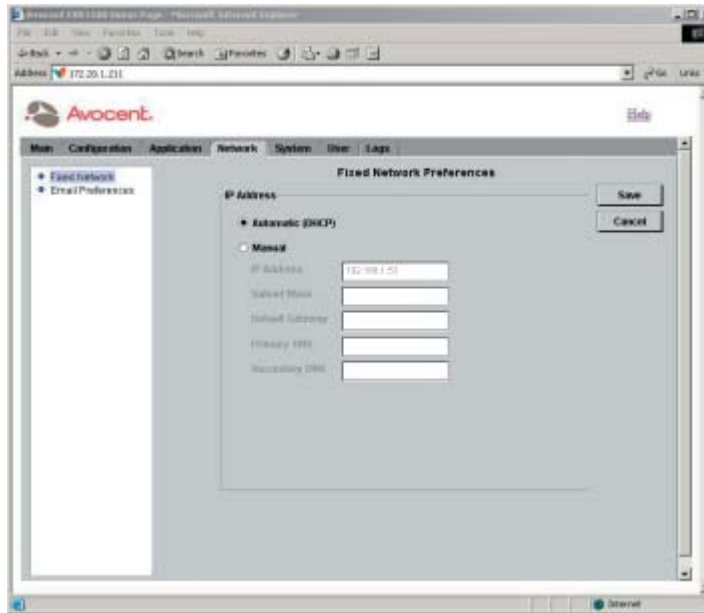

Figure 3.5: Fixed Network Preferences Window

2. Set the EVR1500 environmental monitor appliance for DHCP operation by selecting the *Automatic (DHCP)* button. Proceed to step 4 to obtain a DHCP address by saving the configuration and resetting the appliance.
- or -
Set the EVR1500 environmental monitor appliance for manual operation by selecting the *Manual* button. If you have used HyperTerminal to configure the network, the *Manual* button is selected, and the IP Address, Subnet Mask and Default Gateway fields will display appropriate values. If desired, change the values in the fields. Proceed to step 3.
3. Type the primary and secondary DNS IP address in the Primary and Secondary fields respectively.
4. Click the *Save* button to save the configuration.
- or -
Click the *Cancel* button to revert all configuration items in the Network tab to the last Save operation.
5. Reboot the EVR1500 environmental monitor appliance by selecting *System - Application Update*. Click *Restart*.

Configuring the Email Server

You can set parameters for the SMTP email server address through the web GUI Network tab.

NOTE: Configuring the email server is necessary only if you wish to send alert notifications through email. If you do not intend to use email alerts, you may skip the following instructions.

To configure the email server address:

1. After launching the web GUI, click *Network - Email Preferences*. The Email Preferences window displays the configuration items for setting email preferences.
2. Type the URL or the IP address for the email server in the SMTP Server field.

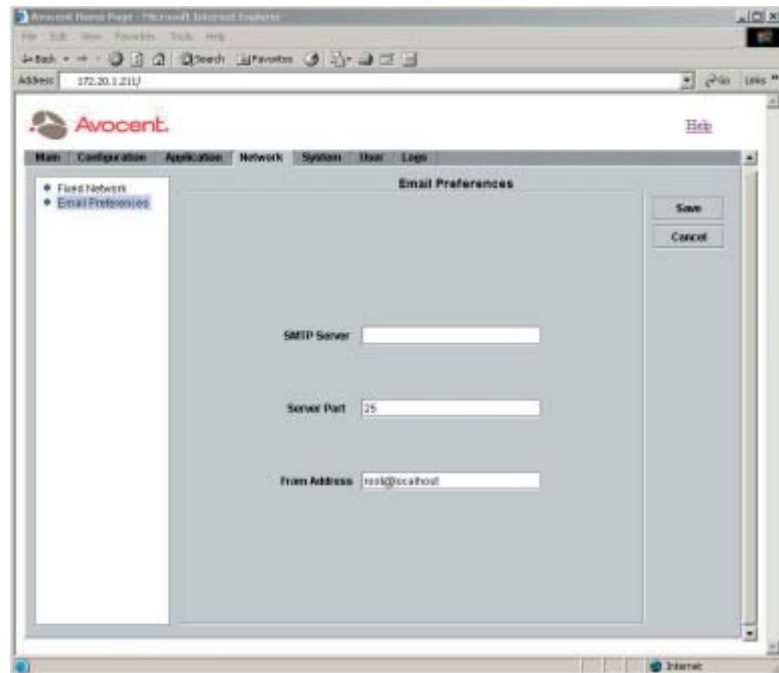

Figure 3.6: Email Preferences Window

NOTE: The SMTP server can be an Internet name (www.yourmailserver.com) or an IP address (192.168.1.1). Consult your email administrator for appropriate values for these fields.

3. In the Server Port field, type the number of the email port on the SMTP Server.
4. In the From Address field, type the email address that will be used in the From address in the email actions.

5. Click the *Save* button to save the settings for your email configuration.
- or -
Click the *Cancel* button to revert all configuration items in the Network tab to the last Save operation.

Setting the Clock

After configuring the network and/or the email server, set the network system time.

To set the clock:

NOTE: The time zone shown on the terminal emulation screen is in Greenwich Mean Time (GMT). The web GUI is set to the Windows time and date settings.

1. After launching the web GUI, click *System - Set Clock*. A window displays configurable items for the clock.

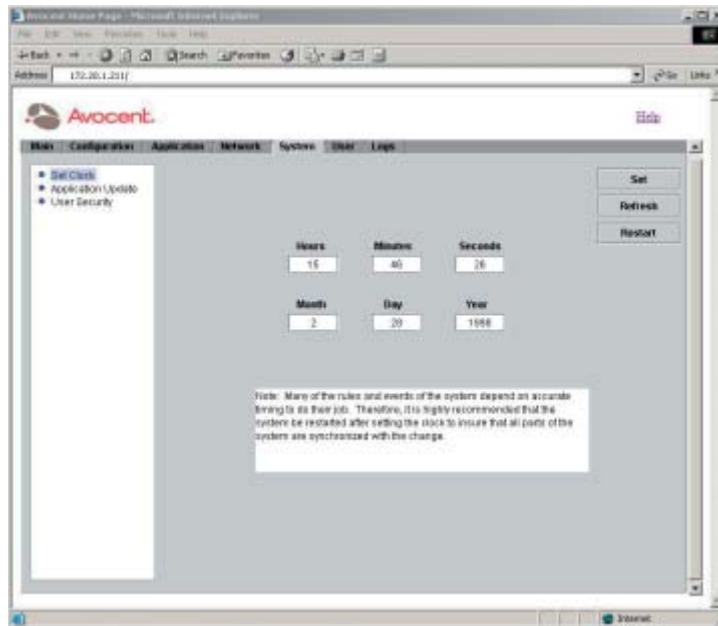

Figure 3.7: Set Clock Window

2. Type the current time in the Hours, Minutes and Seconds fields. For the Hours entry, type a value from 0 to 23. Type the current date in the Month, Day and Year fields. For the Year entry, type a value greater than 2000.

NOTE: Message boxes will display if values are out of range.

3. Click *Set* to save the clock settings.

4. Click *Refresh* to update the display.
5. Click *Restart* to ensure correct configuration on the EVR1500 environmental monitor appliance.

Changing the Login Password

Using the Change Password feature, you can change your login password multiple times during your web session.

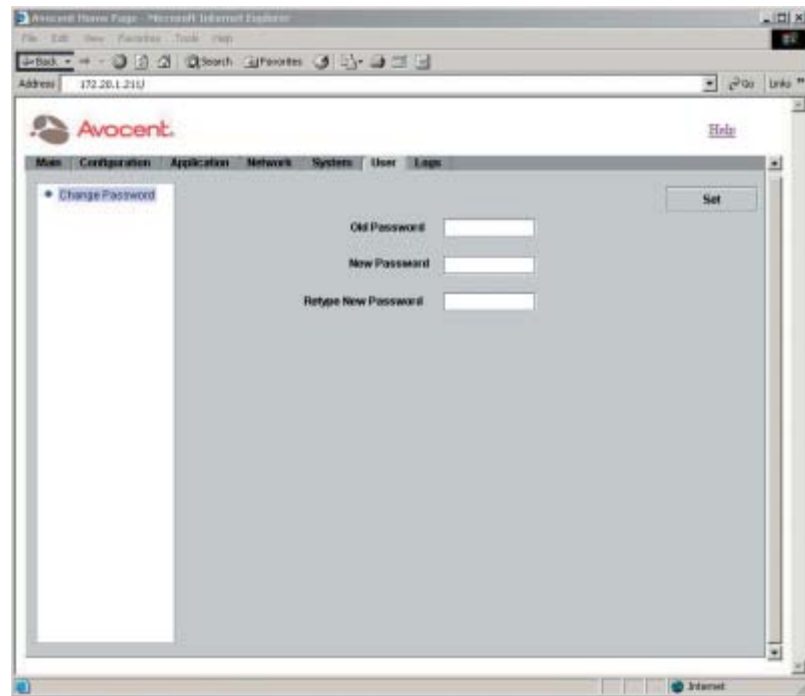

Figure 3.8: Change Password Window

To change your password:

1. After launching the web GUI, click *User - Change Password*. A window displays editable fields for changing your password.
2. Type your old password in the Old Password field.
3. Type your new password in the New Password field.
4. Retype your new password in the Retype New Password field.
5. Click *Set* to save the new password.

Configuring Digital Inputs

After installing the EVR1500 environmental monitor appliance and configuring the network, you can view digital sensor channels and values for each digital input in the system. From the Digital Inputs window, you can also rename digital inputs.

To configure digital inputs:

1. After launching the web GUI, click *Configuration - Digital Inputs*. The Digital Inputs window displays the list of the system's digital inputs.

NOTE: The Channel column is fixed and is the internal representation of the input.

2. Click the row containing the digital sensor input you wish to configure. The sensor input information displays in the dialog box.

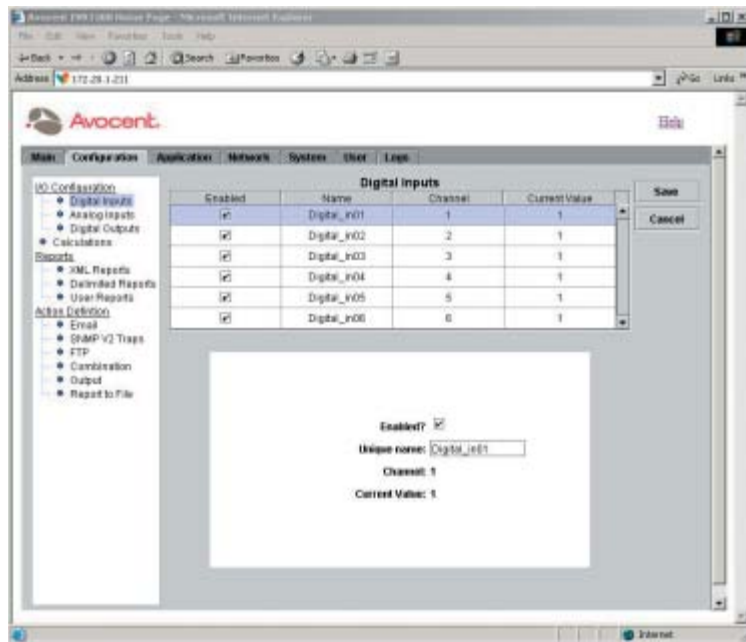

Figure 3.9: Digital Inputs Window

NOTE: In Figure 3.9, the last two digits in the sensor's default name represent the port connecting the sensor to the EVR1500 environmental monitor appliance. It is good practice to use this format when naming sensors.

3. Click the *Enabled* checkbox to enable the selected digital input.

NOTE: An enabled digital input will display in the Main tab window and will be available for use in the following operations: Calculations, SNMP actions, Output actions, Thresholds, Rules, Timed Rules and Reports.

4. If desired, edit the existing name of the digital input by clicking in the Unique name field and typing a new name. The name cannot contain any spaces. The only special character allowed is the underscore (_).
5. If desired, set the threshold for the digital input by clicking *Application - Thresholds*. For instructions, refer to *Setting Thresholds* in Chapter 4.
6. Click *Save* to save the changes made to the digital input(s).
- or -
Click *Cancel* to cancel the updates. Canceling displays the last saved value for the digital input in the Current Value cell for the entire tab.

Configuring Analog Inputs and Internal Sensors

After installing the EVR1500 environmental monitor appliance and configuring the network, you can configure, rename and test analog inputs and internal sensors through the Configuration tab window. Before configuring analog input sensors, be sure you have the necessary information, including input voltage range and convert value range. Typically, each analog sensor is shipped with the sensor's input voltage range and a conversion table showing the actual values interpreted from the voltages. For example, a temperature sensor might have a voltage range of 0 to 5 volts with a conversion range of 5 degrees F (Fahrenheit) to 140 degrees F.

To configure analog inputs and internal sensors:

1. After launching the web GUI, click *Configuration - Analog Inputs*. The Analog Inputs table lists eight inputs, corresponding to the eight RJ-45 connectors on the back of the appliance. Also displayed are the four internal sensors (Temperature, Humidity, Air Flow and Audio) at the bottom of the table.
2. Click the row containing the analog input you wish to configure. The analog input information displays in the dialog box.

NOTE: In Figure 3.10, the last two digits in the sensor's default name represent the port connecting the sensor. It is good practice to use this format when naming sensors.

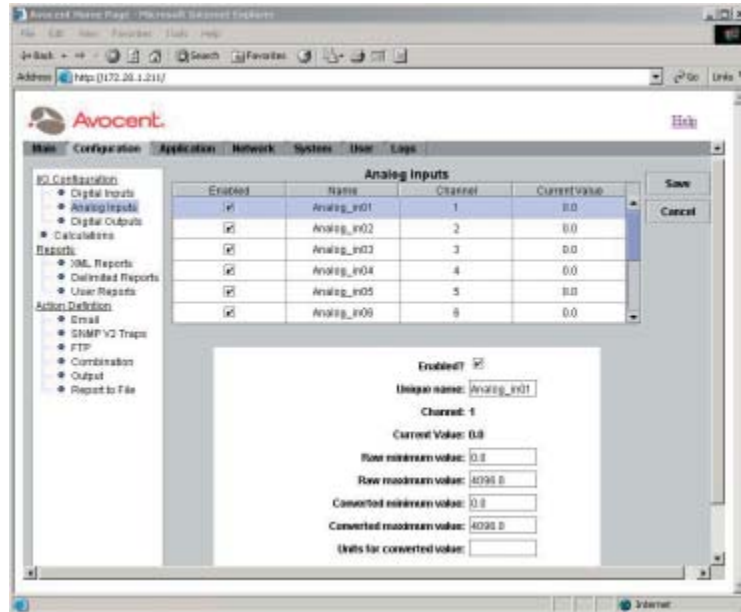

Figure 3.10: Analog Inputs Window

3. Click the *Enabled* checkbox to enable the analog sensor input.

NOTE: An enabled analog input will display in the Main tab window and will be available for use in the following operations: Calculations, SNMP actions, Output actions, Thresholds, Rules, Timed Rules and Reports.

4. If desired, edit the name of the analog input by typing a new name in the Unique name field. The name cannot contain any spaces. The only special character allowed is the underscore (_).
5. Type the minimum voltage input range (for example, 0, 1 or 2 volts) in the Raw minimum value field. This range is the minimum DC voltage range output from the sensor.
6. Type the maximum voltage input range (for example, 5 or 10 volts) in the Raw maximum value field. This value is the maximum DC voltage range output from the sensor.
7. Type the analog input's converted minimum value (for example, -40 degrees F) in the Converted minimum value field.
8. Type the analog input's converted maximum value (for example, 85 degrees F) in the Converted maximum value field.

NOTE: Values for steps 5 to 8 are provided with the analog sensor documentation.

NOTE: The two fields, Converted minimum value and Converted maximum value, enable you to input a conversion range used to mathematically convert an input value from its input range to the conversion range. The EVR1500 environmental monitor provides linear conversion between these values. For example, for a temperature probe with a range of 0 to 5 VDC and a conversion range of -40 to 85 degrees C (Celsius), 1 VDC would be equal to -40 degrees C and 5 VDC would be equal to +85 degrees C.

9. In the Units for converted value field, type the unit you wish to display with the value (for example, degrees F or degrees C).
10. Click *Save* to save the changes made to the analog input(s) and all other items in the Configuration tab.
 - or -
 - Click the *Cancel* button to revert all configuration items in the Configuration tab to the last Save operation.

Configuring Digital Outputs

After installing the EVR1500 environmental monitor appliance and configuring the network, you can configure and rename two digital outputs (plug-in modules 7 and 8) through the Configuration tab interface.

The front panel LEDs (Audio_LED, Air_Flow_LED, Humidity_LED, Temperature_LED) also display in the Digital Outputs window and are defaulted to green [Current Value = 1 (green) or 0 (red)]. Refer to *Setting Thresholds* and *Configuring Rules* in Chapter 4 for instructions on configuring the front panel LEDs.

NOTE: The Heater_Control digital output is used to eliminate excessive condensation from the internal humidity sensor. The default value is 0 or Off. Setting the value to 1 or On for 30 to 60 seconds eliminates condensation.

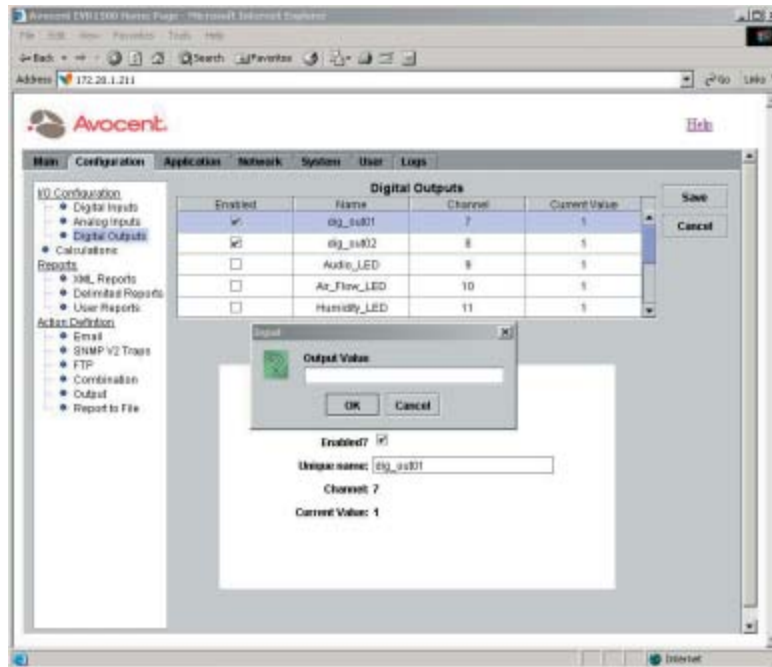

Figure 3.11: Digital Outputs Window

To configure digital outputs:

1. After launching the web GUI, click *Configuration - Digital Outputs*. The Digital Outputs window displays a list of the digital sensor outputs.

NOTE: The Channel column is not editable and is the internal representation of the input.

2. Click the row containing the digital sensor you wish to configure or test. The sensor output information displays in the dialog box.
3. Click the *Enabled* checkbox to enable the digital output.

NOTE: An enabled digital output will be displayed on the Main tab. Enabling a digital output also makes it available for use in the following operations: Calculations, SNMP actions, Output actions, Thresholds, Rules, Timed Rules and Reports.

4. If desired, edit the name of the digital output by clicking in the Unique name field and typing a new name. The name cannot contain any spaces. The only special character allowed is the underscore (_).
5. Click the *Test Selected* button. The *Output Value* box displays, enabling you to set the digital output.
6. Type a value that will be applied to the output channel. Click *OK*. This value will become the digital output's button label. Valid settings are 1 (1 = on) or 0 (0 = off).

NOTE: Clicking the *Test Selected* button does not save the new value.

7. Click the *Save* button to save changes to the digital output(s) and all other items in the Configuration tab.
 - or -
 - Click the *Cancel* button to revert all configuration items in the Configuration tab to the last Save operation.

Configuring Calculations

The Calculations feature enables you to configure an equation and the units used to calculate digital and analog I/O. This feature also enables you to create new calculations or delete existing calculations.

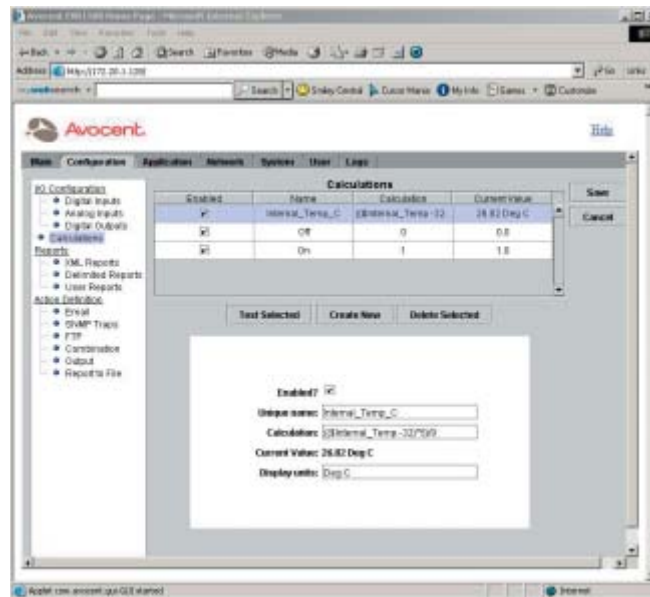

Figure 3.12: Calculations Window

To configure calculations:

1. After launching the web GUI, click *Configuration - Calculations*. The Calculations window displays.
2. Edit an existing calculation by clicking the row containing the calculation.
 - or -
 - Click the *Create New* button to add a calculation. A new row is added to the Calculations list.

The calculation information displays in the dialog box.

- Click the *Enabled* checkbox to enable the calculation.

NOTE: An enabled calculation is available for use in the following operations: SNMP actions, Output actions, Thresholds, Rules, Timed Rules and Reports.

- Type a unique name for the calculation in the Unique name field. The name cannot contain any spaces. The only special character allowed is the underscore (_).

- Type the equation for the calculation in the Calculation field using the format shown in the following example:

Temp_average=(\$temp1+\$temp2+\$temp3)/3

NOTE: Use numbers, arithmetic operators, logic operators and named items from the application. Named items are digital inputs, digital outputs, analog inputs and other calculations as shown in Figure 3.12. These items are referenced using their name (for example, \$temp1) and are preceded with a dollar sign. For example, if analog input Ø is named ana_inØØ in the Analog Input configuration, it can be referenced in an equation as \$ana_inØØ.

- Type the units for the calculation in the Display units field.

NOTE: The field, Display units, requires a string value that is displayed with the result of the equation. It is not interpreted or used to affect the value. For example, in Figure 3.12, the Current Value field contains the display unit Deg C, also shown in the Display unit field.

If appropriate values are not entered, a message box displays a list of available operands. The EVR1500 environmental monitor appliance uses standard C programming language operators and functions. Refer to the following table for the allowed operators and functions.

Language Operators and Functions

Operators	Description
Arithmetic	+, -, *, /
Compare	==, !=, =, <, >=, >
Logical	&&,
Functions	abs, acos, asin, atan, ceil, cos, exp, floor, log, round, sin, sqrt, tan, atan2, max, min, pow, random, counter

- After typing the calculation equation and units, click the *Test Selected* button to perform the calculation. This button must be clicked to refresh the value.
 - A message box displays the new calculation. Click *OK* to exit the message box.
-

NOTE: Clicking the *Test Selected* button does not save the configuration change.

- Click the *Save* button to save all of the items in the Configuration tab.

- OR -

Click the *Cancel* button to revert all configuration items in the Configuration tab to the last Save operation.

To delete a calculation:

1. After launching the web GUI, click *Configuration - Calculations*. The Calculations window displays a list of configured calculations.
2. Click the row containing the calculation you want to delete.
3. Click the *Delete Selected* button.
4. Click the *Save* button to save the change.

Configuring XML Reports

The EVR1500 environmental monitor appliance enables you to generate and send XML reports as email or through FTP. XML reports display sensor I/O values encapsulated in XML format and can be attached directly to an email. Before sending an XML report through FTP, you must write the data to a file using the Report to File action. Using the XML Reports feature, you also can edit, test and delete existing reports.

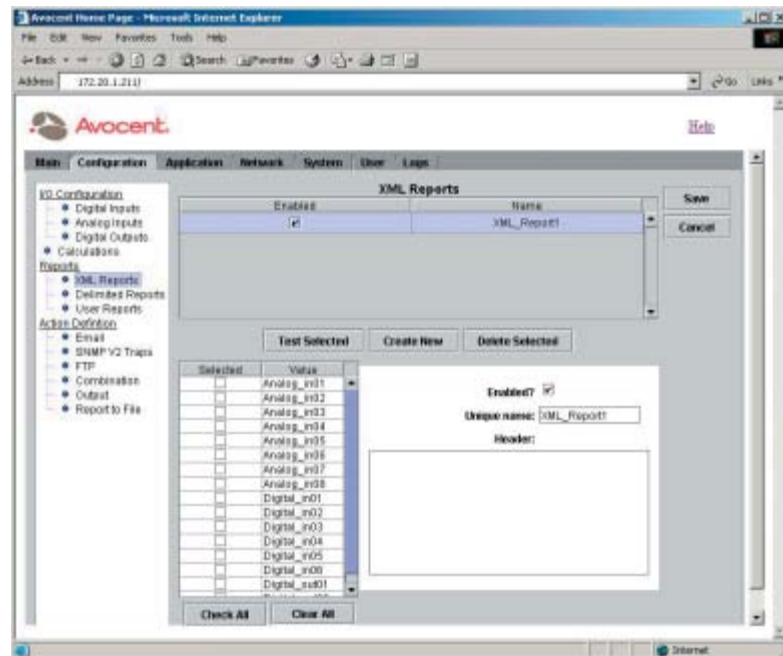

Figure 3.13: XML Reports Window

To configure an XML report:

1. After launching the web GUI, click *Configuration - XML Reports*. The XML Reports window displays XML reports configured in the system. A list of named sensor values that you can include in an XML report also displays.

NOTE: Enabled reports will display in drop-down menu selections and will be available for use in the following operations: Report to File and Email actions.

2. Click the name of the XML report you want to edit.
- or -
Click the *Create New* button to create a new report. A new row is added to the XML Reports table.

The XML report information displays in the dialog box.

3. Click the *Enabled* checkbox to enable the XML report.
4. Type a new name for the report in the Unique name field. The name cannot contain any spaces. The only special character allowed is the underscore (_).
5. Type header information for the XML report in the Header field.
6. In the Values table, click the checkboxes to enable the sensor values you wish to include in the XML report.

NOTE: Click *Check All* or *Clear All* to select or deselect all sensor values for the report.

7. Click the *Test Selected* button to test the report. A message box displays to show the contents of the report you are testing. Click *OK* to exit the message box.

NOTE: Clicking the *Test Selected* button does not save the configuration change.

8. Click *Save* to save all of the configuration items in the Configuration tab.
- or -
Click the *Cancel* button to revert all configuration items in the Configuration tab to the last Save operation.

To delete an XML report:

1. After launching the web GUI, click *Configuration - XML Reports*. The XML Reports window displays the XML reports configured in the system.
2. Click the row containing the XML report you wish to delete.
3. Click the *Delete Selected* button to delete the report.
4. Click *Save* to save the change.

Configuring Delimited Reports

The EVR1500 environmental monitor appliance enables you to generate and send delimited reports as email or through FTP. Delimited reports contain user-defined delimiters that separate sensor data and can be written to spreadsheets or other documents. Before sending a delimited report through FTP, you must write the data to a file using the Report to File action. Using the Delimited Reports feature, you also can edit, test and delete existing delimited reports.

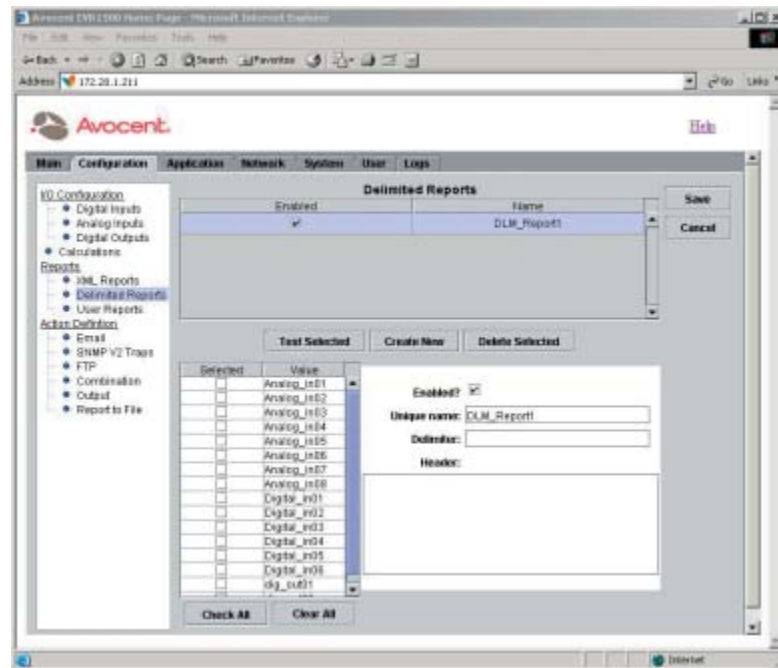

Figure 3.14: Delimited Reports

To configure a delimited report:

1. After launching the web GUI, click *Configuration - Delimited Reports*. The Delimited Reports window displays a list of configured delimited reports and a list of sensor values that you can include in a delimited report.

NOTE: Enabled reports will display in drop-down menu selections and will be available for use in Report to File and Email actions.

2. Click the name of the delimited report you want to edit.
- or -
Click the *Create New* button to add a new report. A new row is added to the Delimited Reports table.

The delimited report information displays in the dialog box.

3. Click the *Enabled* checkbox to enable the delimited report.
4. Type a new name for the report in the Unique name field. The name cannot contain any spaces. The only special character allowed is the underscore (_).
5. Type a delimiter in the Delimiter field. Any delimiter, including colon (:), semicolon (;), comma (,), plus (+), equals (=) and minus (-), may be used.
6. Type header information for the delimited report in the Header field. The values available for inclusion in the report display in the Values table.
7. Under Selected, click the checkboxes to select sensor values you wish to include in the report.

NOTE: Click *Check All* or *Clear All* to select or deselect all sensor values for the report.

8. Click the *Test Selected* button to test the report. A message box displays to show the contents of the report you are testing. Click *OK* to exit the message box.

NOTE: Clicking the *Test Selected* button does not save the configuration change.

9. Click *Save* to save all of the configuration changes in the Configuration tab.
- or -
Click the *Cancel* button to revert all configuration items in the Configuration tab to the last Save operation.

To delete a delimited report:

1. After launching the web GUI, click *Configuration - Delimited Reports*. The Delimited Reports window displays a list of configured delimited reports.
2. Click the row containing the delimited report you wish to delete.
3. Click the *Delete* button to delete the report.
4. Click the *Save* button to save the change.

Configuring User Reports

Using the EVR1500 environmental monitor appliance, you can generate and send user reports as email or through FTP. User reports can be configured as “free form” reports to meet your specific requirements and can be attached directly to an email. Before sending a user report through FTP, you must write the data to a file using the Report to File action. Using the User Reports feature, you also can edit, test and delete existing user reports.

To configure a user report:

1. After launching the web GUI, click *Configuration - User Reports*. The User Reports window displays the user reports configured in the system.

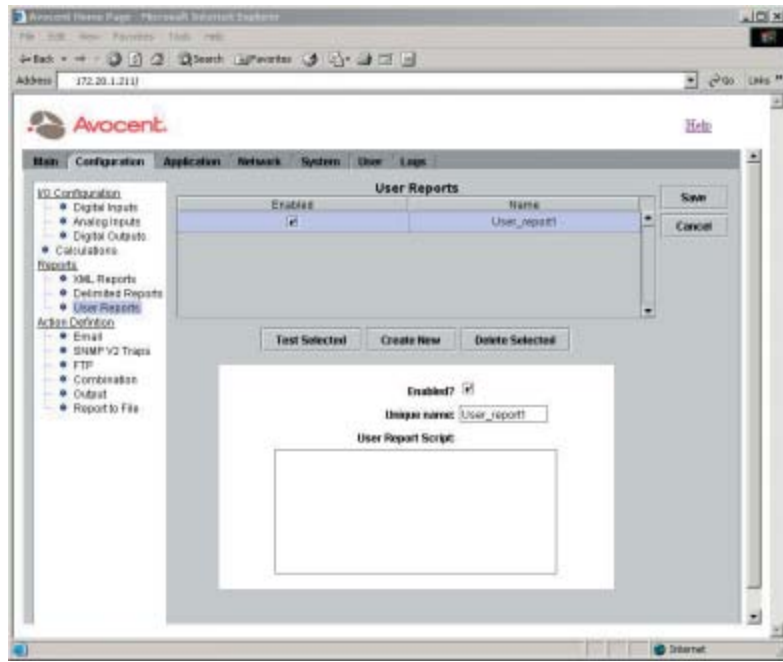

Figure 3.15: User Reports Window

2. Click the name of the user report you want to edit.
- or -
Click the *Create New* button to add a new user report. A new row is added to the User Reports table.

The user report information displays in the dialog box.
3. Click the *Enabled* checkbox to enable the user report.
4. Type a new name for the user report in the Unique name field. The name cannot contain any spaces and the only special character allowed is the underscore (_).
5. Type information for the user report you wish to create in the User Report Script field. Make sure that you type values that are enabled and valid. Precede each value with a dollar sign (\$), for example, \$Analog_Input1.

NOTE: The User Report Script is a free-form field. The text typed into the User Report Script field will be inserted into the user report exactly as you type it.

6. Click the *Test Selected* button to test the report. A message box displays the contents of the report you are testing. Click *OK* to exit the message box. See Figure 3.16 for an example of a user report.

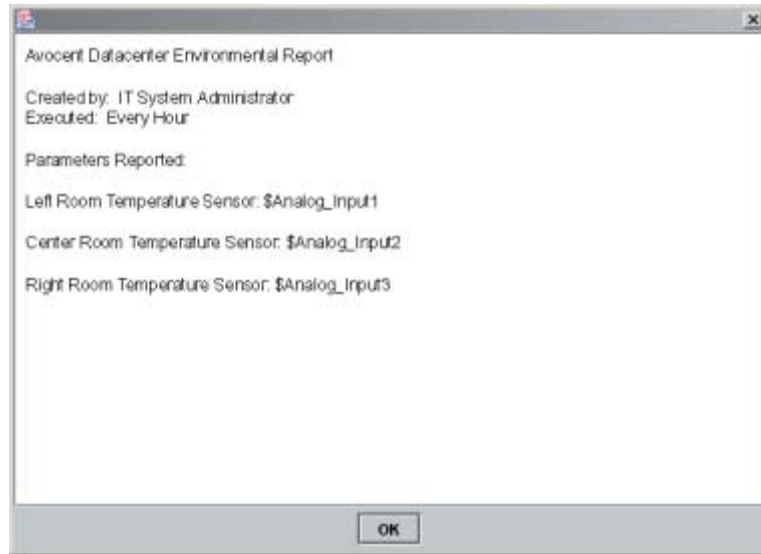

Figure 3.16: User Report

NOTE: Clicking the *Test Selected* button does not save the configuration change.

7. Click the *Save* button to save the changes in the Configuration tab.
- or -
Click the *Cancel* button to revert all configuration items in the Configuration tab to the last Save operation.

To delete a user report:

1. After launching the web GUI, click *Configuration - User Reports*. The User Reports window displays a list of configured user reports.
2. Click the row containing the user report you wish to delete.
3. Click the *Delete Selected* button to delete the report.
4. Click the *Save* button to save the change.

Configuring Email Actions

After you have created a report, you can configure an email action to send your report through email. The report will be displayed as the body of the email. Using the Email feature, you also can edit, test and delete an existing email action. You can configure up to 25 email actions.

NOTE: You must configure your email preferences before you can use the Email feature. Refer to *Configuring the Email Server* in this chapter for instructions.

To configure an email action:

1. After launching the web GUI, click *Configuration - Email*. The Email window displays a list of existing email actions configured in the system.

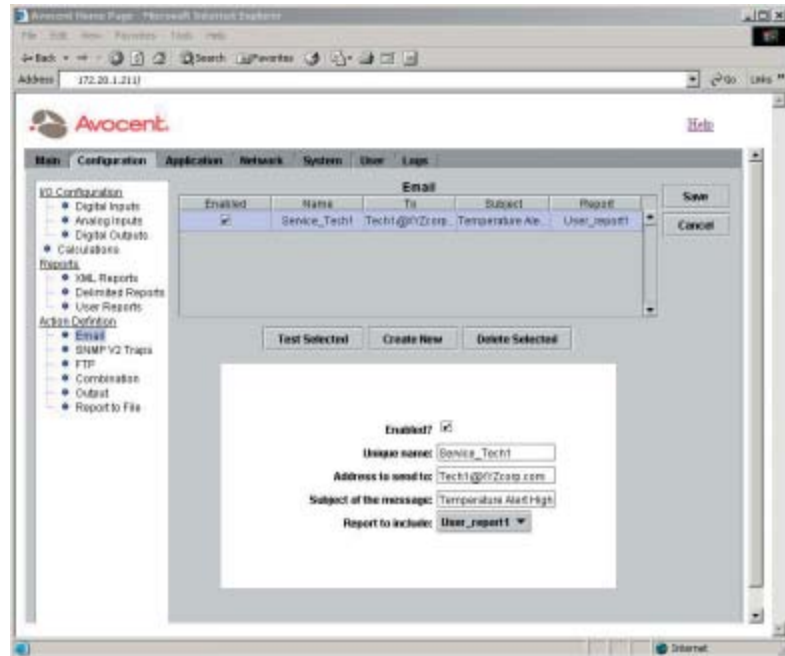

Figure 3.17: Email Window

2. Click the row displaying the email action you want to edit.
- or -
Click the *Create New* button to add a new email action. A new row is added to the Email table.

The email action information displays in the dialog box.

3. Click the *Enabled* checkbox to enable the email action.

NOTE: An enabled email action is available for use in the following operations: Combination actions, Thresholds, Rules and Timed Rules.

4. Type a new name for the email action in the Unique name field. The name cannot contain any spaces, and the only special character allowed is the underscore (_).
5. Type the recipient's email address in the Address to send to field. Only one email address is allowed per entry.
6. Type the subject of the email message in the Subject of the message field.

7. If you wish to include a report as an attachment to the email message, select the report from the drop-down menu labeled Report to include. Selecting a report is optional.

NOTE: The reports displaying in the drop-down menu are enabled XML, delimited and user reports. The selected report is used as the body of the email when it is sent.

8. Click the *Test Selected* button to process the report, if applicable, and send the email with the selected report. Once the action is completed, a message box displays the status of the email being sent and any issues related to the report.

NOTE: The SMTP server is used to send the email. The From email address is configured by selecting *Network - Email*.

9. Click the *Save* button to save all configuration changes in the Configuration tab.
- or -
Click the *Cancel* button to revert all configuration items in the Configuration tab to the last Save operation.

To delete an email action:

1. After launching the web GUI, click *Configuration - Email*. The Email window displays a list of existing email actions configured in the system.
2. Click the row containing the email action you want to delete.
3. Click the *Delete Selected* button to delete the email action in the selected row.
4. Click the *Save* button to save the change.

Configuring SNMP Traps

The SNMP Traps feature monitors and reports alarm conditions on internal or external sensors. You can enable pre-configured traps or develop new trap definitions, which the system uses as actions. Using the SNMP Traps feature, you can also edit, test and delete existing traps.

To configure an SNMP trap:

1. After launching the web GUI, click *Configuration - SNMP Traps*. The SNMP Traps window displays a list of pre-configured traps.

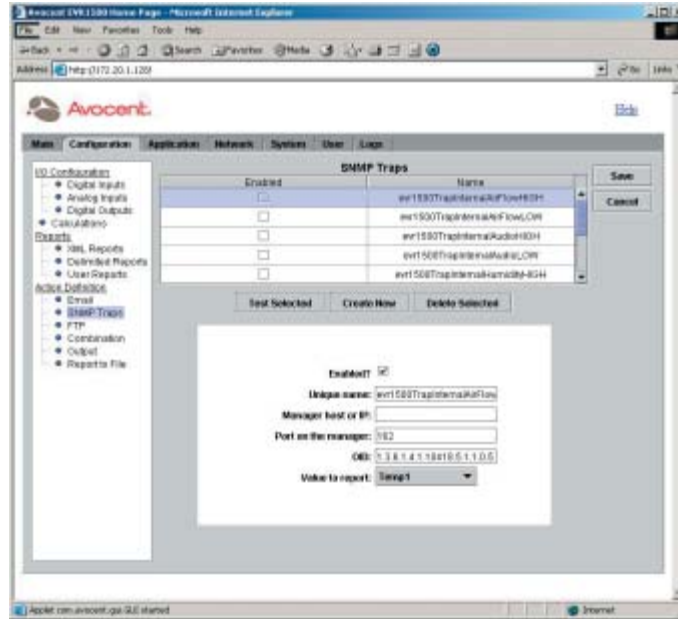

Figure 3.18: SNMP Traps Window

2. Click the name of the trap you wish to edit.
- OR -
Click the *Create New* button to add a new trap. A new row is added to the SNMP Traps table.

The trap information displays in the dialog box.

3. Click the *Enabled* checkbox to enable the trap.

NOTE: An enabled SNMP trap is available for use in the following operations: Combination actions, Thresholds, Rules and Timed Rules.

4. Type a new name for the trap in the Unique name field. The name cannot contain any spaces, and the only special character allowed is the underscore (_).
5. Type the address of the Network Management System (NMS) or the trap collection system in the Manager host or IP (trap collection) field. The EVR1500 environmental monitor appliance will send the traps to these locations.
6. Type a port number for the NMS or trap collection system in the Port on the manager field.

7. For a new trap, type a unique OID (Object Identifier) in the OID field. If the trap is notifying of a high threshold, use the following OID:
1.3.6.1.4.1.10418.5.1.1.9
- or -
If the trap is notifying a low threshold, use the following OID:
1.3.6.11.5.1.10418.5.1.1.10

NOTE: These values conform to the EVR1500 environmental monitor appliance Trap MIB (Management Information Base) described in *Appendix D*. You may also visit www.avocent.com/support for the EVR1500 environmental monitor appliance trap MIB.

The OIDs for pre-configured traps will display in the drop-down menu when you select the trap from the SNMP Traps list.

8. Select a value from the Value to report drop-down menu. The drop-down menu displays all applicable enabled items.

NOTE: The value to report can be an internal sensor, analog input, digital input or calculation that is reported in the trap to the NMS or trap collector.

9. Click the *Test Selected* button to test the trap. A message box displays the status of the trap you are testing. Click *OK* to exit the message box.

NOTE: Clicking the *Test Selected* button does not save the configuration change.

10. Click the *Save* button to save the configuration items in the Configuration tab.
- or -
Click the *Cancel* button to revert all configuration items in the Configuration tab to the last Save operation.

To delete an SNMP trap:

1. After launching the web GUI, click *Configuration - SNMP Traps*. The SNMP Traps window displays a list of configured traps.
2. Click the row containing the trap you wish to delete.
3. Click the *Delete Selected* button to delete the trap.
4. Click the *Save* button to save the change.

Configuring FTP Actions

After you have created a report and converted it to a file using the Report to File action, you can configure FTP actions to send your file through FTP. Using the FTP feature, you also can edit, test and delete an existing FTP action. You can configure up to 25 FTP actions. For details on the Report to File action, refer to *Configuring Report to File Actions* in this chapter.

To configure an FTP action:

1. After launching the web GUI, click *Configuration - FTP*. The FTP window displays a list of existing FTP actions configured in the system.

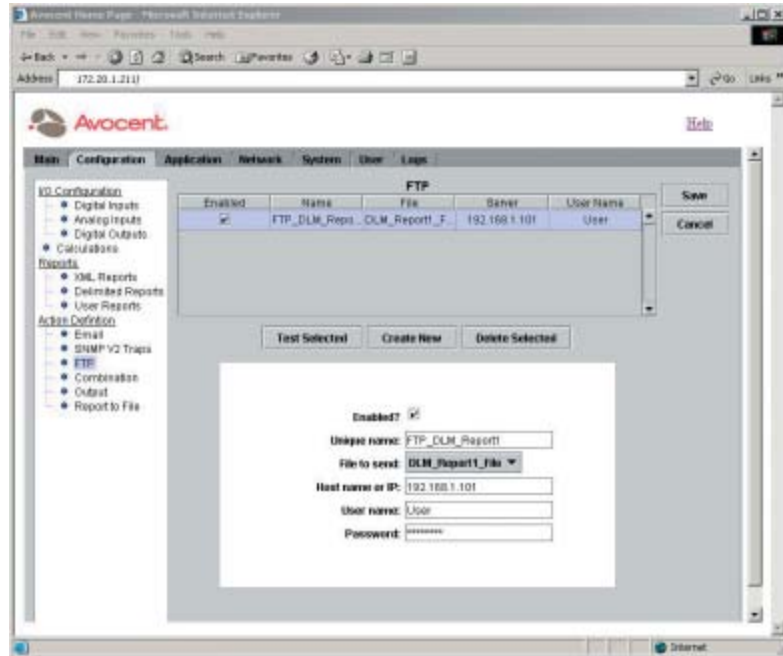

Figure 3.19: FTP Window

2. Click the row containing the FTP action you wish to edit.
-or-
Click the *Create New* button to add a new FTP action. A new row is added to the FTP table.

The FTP information displays in the dialog box.

3. Click *Enabled* to enable the FTP action.

NOTE: An enabled FTP action is available for use in the following operations: Combination actions, Thresholds, Rules and Timed Rules.

4. Type a new name for the FTP action in the Unique name field. The name cannot contain any spaces, and the only special character allowed is the underscore (_).
5. Select a file from the File to Send drop-down menu. The file you select will be sent to the server by the FTP action. After the file is sent, the FTP action deletes the file.

NOTE: Unsuccessful FTP actions do not delete files.

6. In the Host name or IP field, type the FTP server or IP address (or name resolvable through DNS) to which the FTP action will send its file.
7. Type a new username in the User name field.
8. Type the username used to log in to the FTP server in the Password field. The password will be displayed with asterisks (*).

NOTE: The File to send field lists files defined by the Report to File action.

9. Click the *Test Selected* button to process the FTP action. Once the action is completed, a message box displays the results of the action. Click *OK* to exit the message box.
10. Click the *Save* button to save all configuration changes in the Configuration tab.
- or -
Click the *Cancel* button to revert all configuration items in the Configuration tab to the last Save operation.

To delete an FTP action:

1. After launching the web GUI, click *Configuration - FTP*. The FTP window displays a list of FTP actions.
2. Click the row containing the FTP action you want to delete.
3. Click the *Delete Selected* button to delete the FTP action in the selected row.
4. Click the *Save* button to save the change.

Configuring Combination Actions

Using combination actions, you can combine up to four actions and then select the order in which the actions, including Email, SNMP Traps, FTP, Output and Reports, are executed. For instance, you could email a service technician, send an SNMP trap and then run and convert a report into a file, all in a single combination action. Using the Combination feature, you also can edit, test and delete existing combination actions. The system handles up to 25 combination actions.

To configure combination actions:

1. After launching the web GUI, click *Configuration - Combination*. The Combination window displays a list of existing combination actions configured in the system.
2. Edit an existing combination action by clicking the row containing the combination action you wish to edit.
-or-

Click the *Create New* button to add a new combination action. A new row displays in the combination list.

The combination action information displays in the dialog box.

3. Click *Enabled* to enable the Combination action.

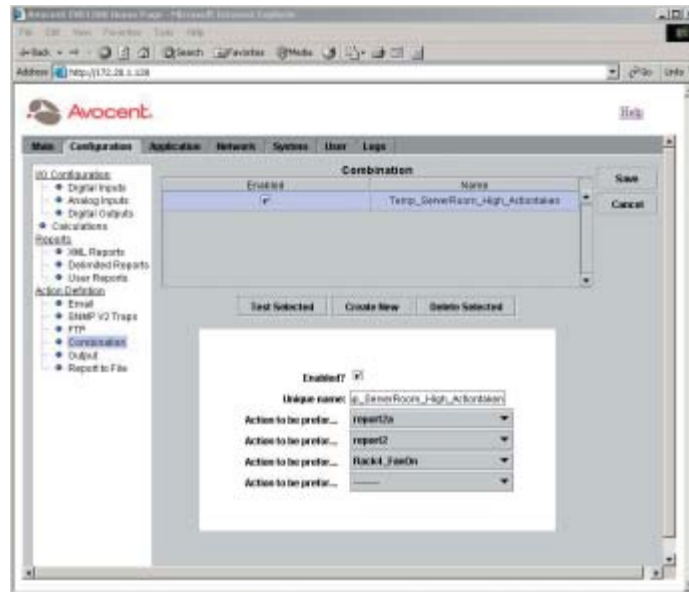

Figure 3.20: Combination Window

NOTE: An enabled combination action is available for use in the following operations: Thresholds, Rules and Timed Rules.

4. Type a unique name for the combination action in the Unique name field. The name cannot contain any spaces. The only special character allowed is the underscore (_).
5. Select actions from the drop-down menus. If the combination action is enabled, you must select at least two actions.

NOTE: Actions 1 to 4 are lists of selectable Email, SNMP Traps, FTP, Output and Report to File actions that have been defined in the system. When a combination action is executed, the actions are executed in sequential order. You do not have to type an action in all four fields. Blank actions, indicated by dashes (-), are not processed by the system.

6. After selecting actions, click the *Test Selected* button to execute the combination action. A message box displays with the results of each action. Click *OK* to exit the message box.
7. Click the *Save* button to save all items in the Configuration tab.
- or -

Click the *Cancel* button to revert all configuration items in the Configuration tab to the last Save operation.

To delete a combination action:

1. After launching the web GUI, click *Configuration - Combination*. The Combination window displays a list of combination actions.
2. Click the row containing the combination action you wish to delete.
3. Click the *Delete Selected* button to delete the combination action.
4. Click the *Save* button to save the change.

Configuring Output Actions

Using the Output actions feature, you can configure output actions from the list of digital and analog I/O in the system. The system handles up to 25 output actions.

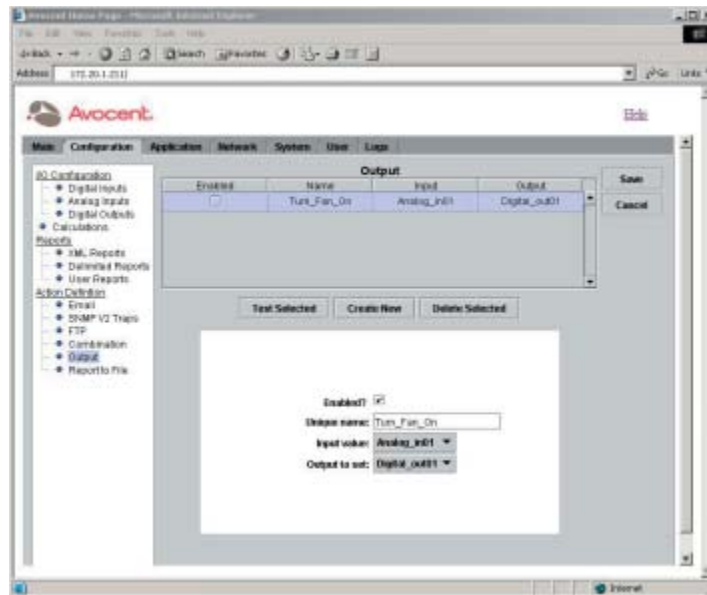

Figure 3.21: Output Window

To configure output actions:

1. After launching the web GUI, click *Configuration - Output*. The Output window displays.
2. Click the row containing the output action you wish to edit. A new row is added to the Output table.
-or-
Add a new output action by clicking the *Create New* button.

The output action information displays in the dialog box.

3. Click *Enabled* to enable the output action.

NOTE: An enabled output action is available for use in the following operations: Combination actions, Thresholds, Rules and Timed Rules.

4. Type a unique name for the output action in the Unique name field. The name cannot contain any spaces. The only special character allowed is the underscore (_).
5. Select an input value from the Input value drop-down menu.
6. Select an output value from the Output to set drop-down menu.

NOTE: The Input value drop-down menu contains named items representing values. When the output action is executed, the values from the selected item in the Input list are applied to the values of the item selected from the Output list.

7. After selecting input and output items, click the *Test Selected* button to execute the output action. A message box displays with the results of the action.
8. Click the *Save* button to save all items in the Configuration tab.
- or -
Click the *Cancel* button to revert all configuration items in the Configuration tab to the last Save operation.

To delete an output action:

1. After launching the web GUI, click *Configuration - Output*. The Output window displays a list of output actions.
2. Click the row containing the output action you wish to delete.
3. Click the *Delete Selected* button.
4. Click the *Save* button to save the change.

Configuring Report To File Actions

The Report to File feature enables you to convert XML, delimited and user reports to files that can be sent through the FTP action. The Report to File action can be executed from Combination actions, Thresholds, Rules and Timed Rules. The EVR1500 system handles up to 25 Report to File actions.

To configure Report to File actions:

1. After launching the web GUI, click *User - Report to File*. The Report to File window displays.

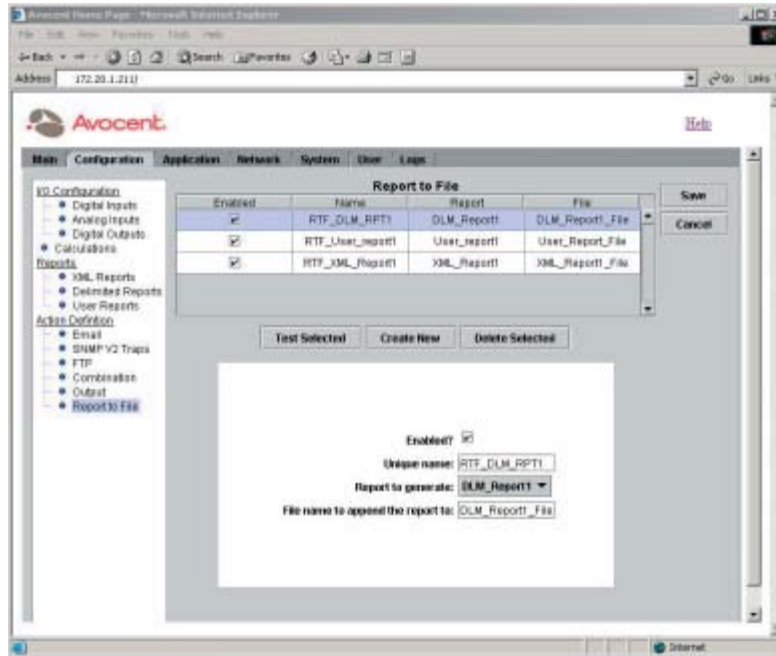

Figure 3.22: Report to File Window

2. Click the row containing the Report to File action you wish to configure.
-or-
Add a new Report to File action by clicking the *Create New* button. A new row is added to the Report to File table.

The Report to File action information displays in the dialog box.

3. Click *Enabled* to enable the Report to File action.

NOTE: An enabled Report to File action is available for use in the following operations: Combination actions, Thresholds, Rules and Timed Rules.

4. Type a unique name for the Report to File action in the Unique name field. The name cannot contain any spaces. The only special character allowed is the underscore (_).
5. Select the report you want to use for the Report to File action from the Report to generate drop-down menu.

NOTE: The reports displayed in the drop-down menu are XML, delimited and user reports.

6. Select a report name from the File name to append the report to drop-down menu. The system will process the report and save the results in the named file.

7. Click the *Test Selected* button to execute the Report to File action. A message box displays with the results of the action. Click *OK* to exit the message box.
8. Click the *Save* button to save all items in the Configuration tab.
- or -
Click the *Cancel* button to revert all configuration items in the Configuration tab to the last Save operation.

To delete a Report to File action:

1. After launching the web GUI, click *Configuration - Report to File*. The Report to File window displays.
2. Click the row containing the Report to File action you wish to delete.
3. Click the *Delete Selected* button to delete the Report to File action.
4. Click the *Save* button to save the change.

Viewing Logs

The Logs feature enables you to display a Linux system log file and the five most recent application log files. The application logs are deleted after cycling from the current log file to the oldest. The system and application logs are described as follows:

- System Log: Linux system log
- App. Log - Cur: Current system application messages
- App. Log - 2: Historical log (newest)
- App. Log - 3: Historical log
- App. Log - 4: Historical log
- App. Log - 5: Historical log (oldest)

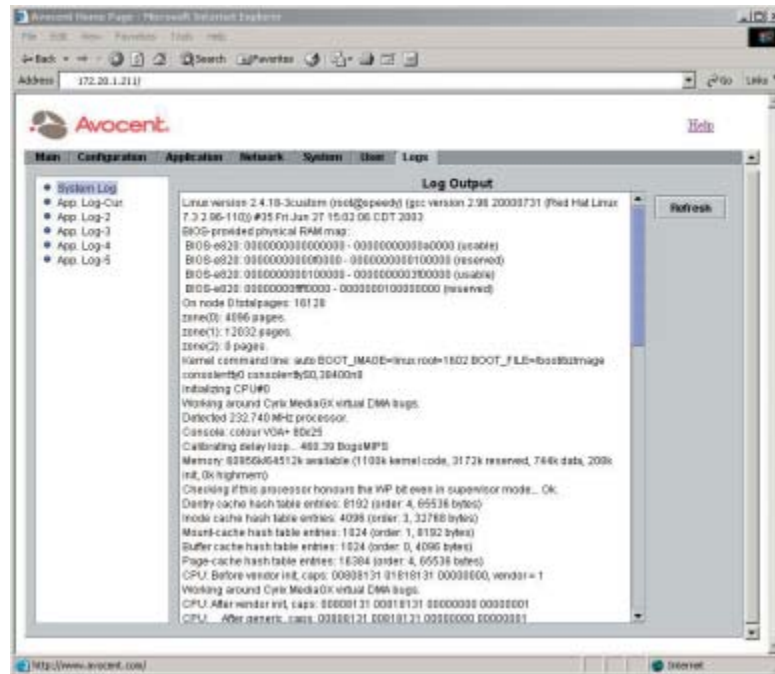

Figure 3.23: Log Output Window

To view system logs:

1. After launching the web GUI, click the *Logs* tab. The Logs window displays names of system and application logs.
2. Click the log file you wish to review. The Log Output window displays the contents of the log file you selected.

NOTE: The size of the log files is limited to 100K. New log data messages replace the oldest log messages when this file size is exceeded. The timestamps in the log windows are in GMT format. The system is set to local time.

3. Click *Refresh* to update the view.

NOTE: The Log Output window is a snapshot view and is not automatically updated.



4 **Advanced Operations**

- *Contents*

- Setting Thresholds* 53
- Configuring Rules* 55
- Configuring Timed Rules* 57
- Configuring User Security* 58

Chapter 4: Advanced Operations

Setting Thresholds

The Thresholds feature enables you to set thresholds for analog and digital inputs and to configure the frequency that Email, Combination, FTP, Output and Report to File actions are processed against the threshold. The EVR1500 environmental monitor appliance handles up to 25 thresholds.

The threshold information shown in Figure 4.1 is used to monitor a temperature probe connected to an analog input. The threshold will monitor the selected analog input (Analog_in01) every 60 seconds. If the value of Analog_in01 meets or exceeds 85 degrees F, the selected Combination action (Combo_Action1) will execute. The Combination action will execute one time and then wait for the release value to reset. Once it is reset, the action will execute again if 85 degrees F is exceeded. A threshold action is reset when the temperature sensor first reports an input voltage that is less than the release value of 75 degrees F. Once the temperature has dropped below 75 degrees F, the action is reset.

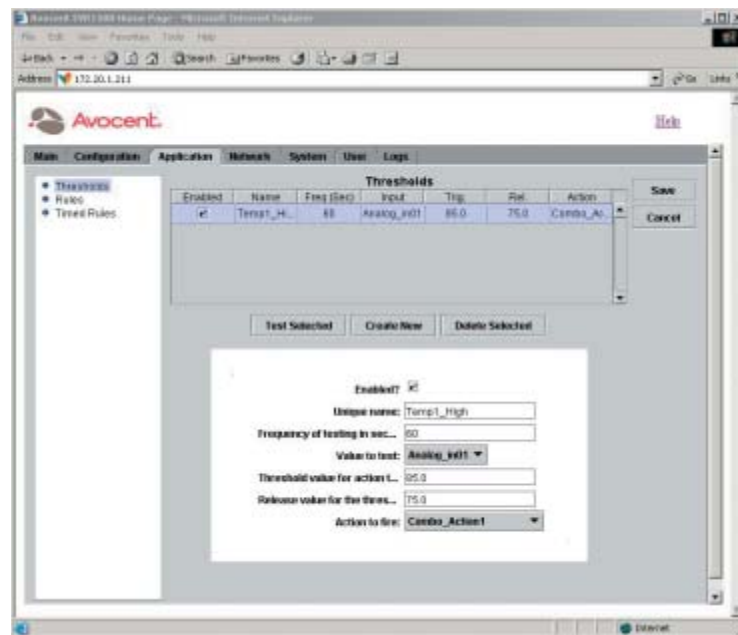

Figure 4.1: Thresholds Window

To configure a threshold:

1. After launching the web GUI, click *Application - Thresholds*. The Thresholds window displays thresholds configured in the system.
2. Click *Create New* to add a new threshold to the list. A new row is added to the thresholds table.
-or-
Click the threshold you wish to configure.

The threshold information displays in the dialog box.

3. Click the *Enabled* checkbox to enable the threshold. An enabled threshold is processed at the selected frequency by the system.
4. Type a new name for the threshold in the Unique name field. The name cannot contain any spaces. The only special character allowed is the underscore (_).
5. Type a new value (in seconds) in the Frequency of testing in seconds field. The value you enter is the frequency that the system will evaluate the enabled threshold.
6. Select an input from the Value to test drop-down menu.
7. Enter a new value in the Threshold value for action to fire field.
8. Enter a new value in the Release value for the threshold field.

NOTE: If the Trig value is greater than the Rel value, the threshold is a Trigger High Event; if the Trig value is less than the Rel value, the threshold is a Trigger Low Event.

9. Select an action from the Action to fire drop-down menu. All enabled actions will display in the list. This action is executed when the threshold has been exceeded.

NOTE: The action will execute once when the threshold has been exceeded and will wait for the release value to reset. Once the value has been reset, the action will execute again, if the threshold is exceeded.

10. After configuring the new or existing threshold, click the *Test Selected* button to evaluate the input, the Trig/Rel values and the state of the threshold. This command also executes the action, if the values are appropriate. A message box displays with the results of the test. Click *OK* to exit the message box.
11. Click the *Save* button to save the configuration items in the Application tab.
- or -
Click the *Cancel* button to revert all configuration items in the Application tab to the last Save operation.

To delete a threshold:

1. After launching the web GUI, click *Application - Thresholds*. The Thresholds window displays a list of thresholds.
2. Click the row containing the threshold you wish to delete.
3. Click the *Delete* button to delete the selected threshold.
4. Click the *Save* button to save the change.

Configuring Rules

The Rules feature enables you to configure periodic if-then-else rules used to process Email, SNMP Traps, Combination, FTP, Output and Report to File actions. Using the Rules feature, you can also edit, test and delete an existing rule. The system can handle up to 25 rules.

The rule shown in Figure 4.2 is used to control a fan connected to a digital output. The value in the Value to test field (Temp1) is a calculation that will equal 1 if an analog input exceeds 85 degrees F. If the analog input falls below 85 degrees F, the Temp1 calculation will equal 0. This rule scans the Fan_Temp calculation every 60 seconds and either turns the output connected to the fan on (Temp1 = 1) or off (Temp1 = 0). An output action is used to toggle the digital output.

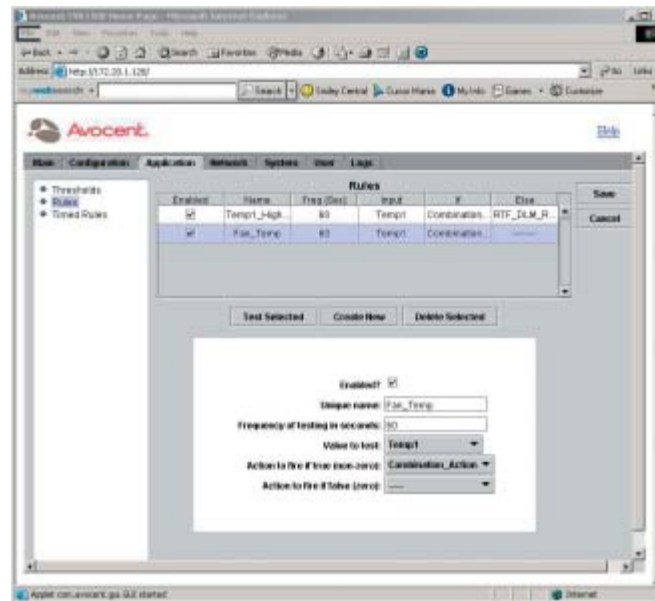

Figure 4.2: Rules Window

To configure a rule:

1. After launching the web GUI, click *Application - Rules*. The Rules window displays a list of rules.
2. Click *Create New* to add a rule. A row is added to the rules table.
-or-
Click the rule you wish to edit.

The rules information displays in the dialog box.
3. Click the *Enabled* checkbox to enable the rule. An enabled rule is processed periodically by the system.
4. Type a new name for the rule in the Unique name field. The name cannot contain any spaces. The only special character allowed is the underscore (_).
5. Type a new value (in seconds) in the Frequency of testing in seconds field. The value you type is the frequency that the system will process the enabled rule.
6. Select an input from the Value to test drop-down menu.
7. Select an option from the Action to fire if true drop-down menu. You must select an option from this list if the option is a rule for an enabled Email, SNMP Trap, Combination, FTP, Output or Report to File action.
8. (Optional) Select an option from the Action to fire if false drop-down menu.
9. After configuring the new or existing rule, click the *Test Selected* button to evaluate the rule. A message box displays with the results of the test. Click *OK* to exit the message box.

NOTE: When a rule is evaluated by the system, the Input (value) is evaluated. If the Input is a non-zero value, the Action to fire if true action is executed. If the If input is \emptyset , the Action to fire if false action is executed.

10. Click the *Save* button to save all items in the Application tab.
- or -
Click the *Cancel* button to revert all configuration items in the Application tab to the last Save operation.

To delete a rule:

1. After launching the web GUI, click *Application - Rules*. The Rules window displays a list of rules.
2. Click the row containing the rules you wish to delete.
3. Click the *Delete* button to delete the selected rule.
4. Click the *Save* button to save the change.

Configuring Timed Rules

From the Timed Rules window, you can configure the frequency that the timed rules operation will process Email, Combination, FTP, Output and Report to File actions. Using the Timed Rules feature, you also can edit, test and delete an existing timed rule. The system handles up to 25 timed rules.

The timed rule shown in Figure 4.3 is used to send the FTP_Temp_File (action) every 60 minutes. The FTP file contains one report or several reports written to a file (Temp_File) using the Report to File action. Before configuring a timed rule, you must create the FTP action (FTP_Temp_File) using the FTP option in the Configuration tab.

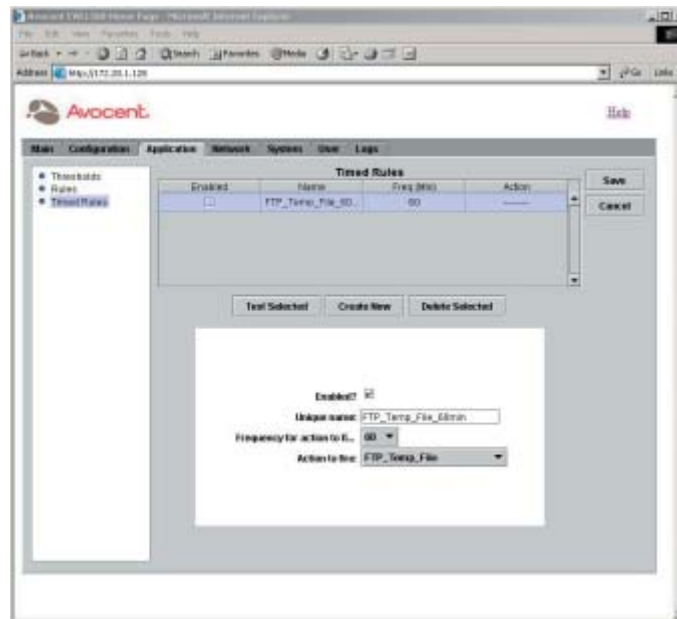

Figure 4.3: Timed Rules Window

To configure a timed rule:

NOTE: When a timed rule is evaluated by the system, the Freq(Min) value is evaluated against the system clock. If appropriate, the action is processed.

1. After launching the web GUI, click *Application - Timed Rules*. The Timed Rules window displays a list of timed rules.
2. Click *Create New* to add a new timed rule. A new row is added to the Timed Rules table.
-or -
Click the timed rule you wish to configure.

The timed rule information displays in the dialog box.

3. Click the *Enabled* checkbox to enable the timed rule. An enabled timed rule is processed periodically by the system.
4. Type a new name for the timed rule in the Unique name field. The name cannot contain any spaces. The only special character allowed is the underscore (_).
5. Select a new value (in minutes) from the Frequency for action to fire drop-down menu. The number of minutes you select is the frequency that the system will process the enabled timed rule. For example, if you select 5 from the list, the timed rule will execute its action at five-minute intervals.
6. Select an action from the Action to fire drop-down menu.
7. After configuring the new or existing timed rule, click the *Test Selected* button to evaluate the timed rule. A message box displays with the results of the test. Click *OK* to exit the message box.
8. Click the *Save* button to save all configuration items in the Application tab.
- or -
Click the *Cancel* button to revert all configuration items in the Application tab to the last Save operation.

To delete a timed rule:

1. After launching the web GUI, click *Application - Timed Rules*. The Timed Rules window displays a list of timed rules.
2. Click the row containing the timed rule you wish to delete.
3. Click the *Delete* button to delete the selected timed rule.
4. Click the *Save* button to save the change.

Configuring User Security

The User Security feature enables the system administrator to set custom security levels, including Full Access, View Only Access or No Access for each user in the system.

To configure user security:

1. After launching the web GUI, click *System - User Security*. The User Security window displays.
2. Click *Add* to add a new user. In the dialog box that displays, enter your username and click *OK*. A dialog box displays. A new row is added to the User Name list.
-or -

Click a username to edit security settings. A dialog box displays drop-down menus for configuring user privileges.

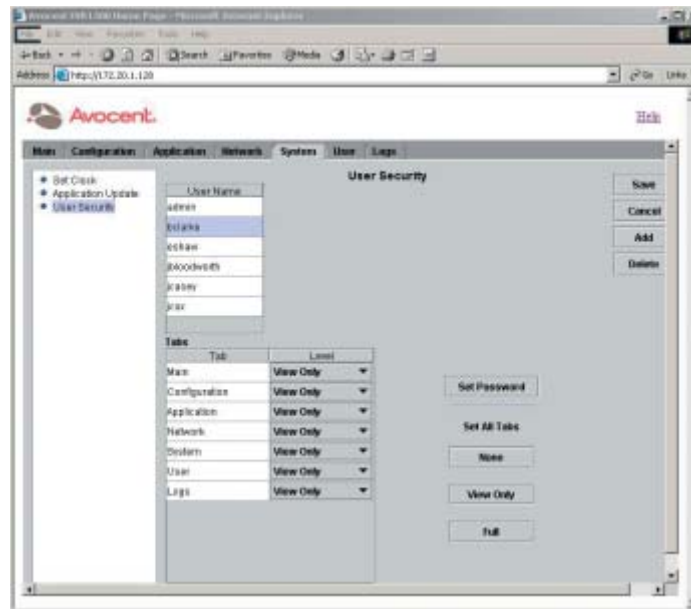

Figure 4.4: User Security Window

3. Click the *Set Password* button to set the password for the selected user.
4. Configure user access to the system by selecting options from the drop-down menu for each feature tab.
- or -

Under *Set All Tabs*, click *None*, *View Only* or *Full* to set all tabs to a single setting as follows:

- *None* - The user cannot view or select the tab.
- *View Only* - The user can view, but not edit, tab information.
- *Full* - The user can view and edit tab information.

5. Click *Save* to save the change.
-or-
Click the *Cancel* button to revert all configuration items in the System tab to the last Save operation.

To delete user security settings:

1. Click *System - User Security*. The User Security window displays a list of user security settings.

2. Click the username you wish to delete.

NOTE: You cannot delete the admin account.

3. Click the *Delete* button to delete the selected user.
4. Click the *Save* button to save the change.



Appendices

- *Contents*

<i>Appendix A: Application Updates</i>	63
<i>Appendix B: Technical Specifications</i>	65
<i>Appendix C: EVR1500 Environmental Monitor Appliance Pinouts</i> ..	67
<i>Appendix D: SNMP Trap MIB</i>	70
<i>Appendix E: Customer-Supplied Sensors</i>	72
<i>Appendix F: Technical Support</i>	73

Appendices

Appendix A: Application Updates

The Application Update feature enables you to update the EVR1500 environmental monitor appliance with the latest version of the system Java JAR file. To perform this update, you will need an FTP or HTTP (Hypertext Transfer Protocol) server to store the new file.

To update the JAR file:

1. Verify that the updated JAR file is located on an FTP or HTTP server and determine the exact directory address and filename of the file.
2. After launching the web GUI, click *System - Application Update*. The Application Update window displays.

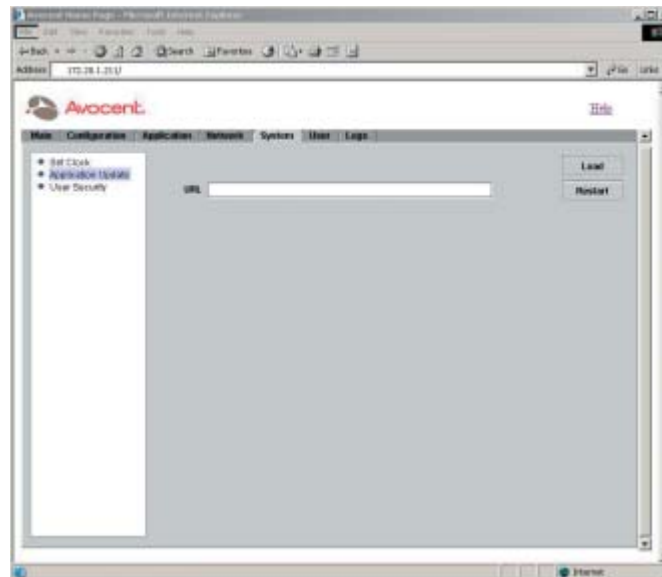

Figure A.1: Application Update Window

3. Visit the Avocent web site at <http://www.avocent.com/support> to obtain the updated Avocent.JAR file.
4. Click the URL field in the Application Update window and type the URL of the JAR file. For example:
**FTP://USERID:PASSWORD@192.168.1.10/
EVR1500/Softwaredownloads/Avocent.JAR**

NOTE: You must supply a user ID and password that is valid for the FTP server on 192.168.1.10.

5. Click the *Load* button. Wait for a message indicating that the file has downloaded successfully.

6. Click the *Restart* button to complete the upload. Wait for a few minutes for the system to restart.
7. Clear the temporary cache files on your PC as follows:
 - a. From Internet Explorer, click *Tools - Internet Options*. The Internet Options dialog box displays. In the Internet Options dialog box, select *Temporary Internet Files - Delete Files*.
 - b. From the Windows Start menu, click *Settings - Control Panel*. In the Control Panel, double-click the *JAVA Plug-in* icon. In the Java Plug-in Control Panel, click the *Cache* tab. Confirm the operation by clicking *yes* in the Confirmation Needed message box.
8. Close Internet Explorer and log in again.
9. Click the *Main* tab and verify the new version of the application in the System Summary section.

Appendix B: Technical Specifications

EVR1500 Environmental Monitor Appliance Specifications

USB Ports

Number	2
Types	USB 1.0 compliant
Connectors	RJ-45

Configuration Port

Number	1
Type	Serial RS-232
Connector	DB9 male
Setup	Baud Rate: 38.4 KBPS; Bits: 8; Parity: None; Stop Bits: 1

Network Connection

Number	1
Type	Ethernet: IEEE 802.3, 10/100BaseT,
Connector	RJ-45

Analog Input Sensor Ports

Number	8
Type	Voltage input: 0 to 40 V range
Resolution	20 bit A/D converter; 238.4 uV/bit
Connector	RJ-45
Power	Each port outputs 12 VDC to power sensors
Supports	Sensors supplied by Avocent or a third party

Digital Input Sensor Ports

Number	6
Type	Contact closure; 2 pins per connector
Connector	Phoenix-style removable plug-in; accepts bare wire; terminals 1 to 6
Supports	Sensors supplied by Avocent or a third party

Digital Output Sensor Ports

Number	2
Type	Open Collector; current sink
Connector	Phoenix-style removable plug-in; accepts bare wire; terminals 7 to 8
Output voltage	+5 VDC
Sink current	100 mA

EVR1500 Environmental Monitor Appliance Specifications (continued)

Dimensions

Dimensions (H x W x D)	4.2 x 21.5 x 20.5 cm 1U form factor (1.75 x 8.5 x 8 in)
Weight	3.5 lbs without cables
Power consumption	25 W
Input power	+5 VDC/+12 VDC supplied from external DC power brick
AC-input voltage rating	90 to 264
AC-input frequency rating	47 to 63 Hz
AC-input current rating	1.35 Amps @ 115 VAC
AC-input cable	18 AWG four-wire cable, from brick to appliance (supplied); IEC-320 receptable accepts country- specific cords for connection from unit to wall (not supplied)
Humidity	10 to 95% noncondensing
Operating temperature	32° F to 104° F (0° to 40° C)
Storage temperature	-4° F to 158° F (-20° C to 70° C)

EMC and Safety Approvals

USA (UL, FCC), Canada (cUL), European Union (CE), Japan (VCCI),
Australia (C-tick)

Appendix C: EVR1500 Environmental Monitor Appliance Pinouts

This appendix provides pinouts and signal definitions for the following EVR1500 environmental monitor appliance connectors: analog sensors (RJ-45), digital I/O (eight-wire insert), COM1 (RS-232) serial port, Ethernet 10/100 BaseT and VGA display. Figure C.1 shows the digital I/O connections on the appliance terminal blocks.

Analog Sensor Connectors

RJ-45 Pin	Signal Name	Description
1	GND	Signal ground
2	N/C	Not connected
3	N/C	Not connected
4	N/C	Not connected
5	Vin	Voltage input
6	NC	Not connected
7	N/C	Not connected
8	+12 VDC	+12 VDC output

Digital I/O connectors

Each digital I/O requires two connections, as shown in Figure C.1. Digital inputs (1 to 6) connect to dry contact closures. Digital outputs (7 and 8) provide 0 or 5 VDC and require ground connection.

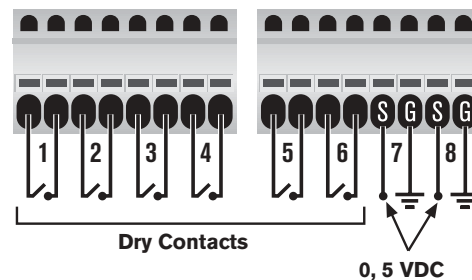

Figure C.1: Digital Sensor Connections on Terminal Blocks

COM 1 Serial Port Connector

RS-232	Signal Name	Description
1	DCD	Data carrier detect
2	RXD	Receive data
3	TXD	Transmit data
4	DTR	Data terminal ready
5	GND	Signal ground
6	DSR	Data set ready
7	TRTS	Transmit ready to send
8	CTS	Clear to send
9	RI	Receive interrupt

Ethernet 10/100 BaseT Connector

Pin	Signal Name	Description
1	XMIT+	Transmit output
2	XMIT-	Transmit input
3	RCV+	Receive output
4	N/C	Not connected
5	N/C	Not connected
6	RCV-	Receive input
7	N/C	Not connected
8	N/C	Not connected

VGA Display Connector

Pin	Signal Name	Description
1	Red	Red
2	Green	Green
3	Blue	Blue
4	N/C	Not connected
5	GND	Signal ground
6	GND	Signal ground
7	GND	Signal ground
8	GND	Signal ground
9	VDDC	Battery
10	GND	Signal ground

VGA Display Connector (continued)

Pin	Signal Name	Description
11	N/C	Not connected
12	DDC DAT	DDC data
13	H-SYNC	Horizontal synchronization
14	V-SYNC	Vertical synchronization
15	DDC CL	DDC clock

Appendix D: SNMP Trap MIB

This appendix provides the SNMP trap MIB definitions. The EVR1500 environmental monitor appliance supports pre-configured traps, which can be used in Combination actions, Thresholds, Rules and Timed Rules.

EVR1500 Environmental Monitor Appliance Trap MIB Definitions

evr1500TrapValueName	
Type	Object-Type
Description	This object is sent in a trap to identify the configured name of the trap value.
Syntax	Octet String (Size (1..25))
evr1500TrapValue	
Type	Object-Type
Description	This object is sent in a trap to give the value read on the sensor.
Syntax	Octet String (Size (1..25))
evr1500TrapInternalTempHIGH	
Type	Trap-Type
Description	The internal temperature sensor has sampled a value that exceeds the configured threshold.
Variables	{ evr1500TrapValueName, evr1500TrapValue }
evr1500TrapInternalTempLOW	
Type	Trap-Type
Description	The internal temperature sensor has sampled a value that is below the configured threshold.
Variables	{ evr1500TrapValueName, evr1500TrapValue }
evr1500TrapInternalHumidityHIGH	
Type	Trap-Type
Description	The internal humidity sensor has sampled a value that exceeds the configured threshold.
Variables	{ evr1500TrapValueName, evr1500TrapValue }
evr1500TrapInternalHumidityLOW	
Type	Trap-Type
Description	The internal humidity sensor has sampled a value that is below the configured threshold.
Variables	{ evr1500TrapValueName, evr1500TrapValue }

**EVR1500 Environmental Monitor Appliance Trap MIB
Definitions (continued)**

evr1500TrapInternalAirFlowHIGH	
Type	Trap-Type
Description	The internal air flow sensor has sampled a value that exceeds the configured threshold.
Variables	{ evr1500TrapValueName, evr1500TrapValue }
evr1500TrapInternalAirFlowLOW	
Type	Trap-Type
Description	The internal air flow sensor has sampled a value that is below the configured threshold.
Variables	{ evr1500TrapValueName, evr1500TrapValue }
evr1500TrapInternalAudioHIGH	
Type	Trap-Type
Description	The internal audio sensor has sampled a value that exceeds the configured threshold.
Variables	{ evr1500TrapValueName, evr1500TrapValue }
evr1500TrapInternalAudioLOW	
Type	Trap-Type
Description	The internal temperature sensor has sampled a value that below the configured threshold.
Variables	{ evr1500TrapValueName, evr1500TrapValue }
evr1500TrapThresholdHIGH	
Type	Trap-Type
Description	The channel sensor has sampled a value that exceeds the configured threshold.
Variables	{ evr1500TrapIValueName, evr1500TrapValue }
evr1500TrapThresholdLOW	
Type	Trap-Type
Description	The channel sensor has sampled a value that is below the configured threshold.
Variables	{ evr1500TrapValueName, evr1500TrapValue }

Appendix E: Customer-Supplied Sensors

Customer-supplied sensors used with the EVR1500 environmental monitor appliance must meet the requirements shown in the following table.

Requirements for Customer-Supplied Sensors

Analog Sensors	Requirements
Power	Must accept 12 VDC if powered by EVR1500 environmental monitor appliance.
Input Voltage	Positive voltage between 0 to 40 V; Example input minimum voltages are 1, 0, 0, 2. Example input maximum voltages are 5, 5, 10, 10.
Input Current	4-20 mA sensors can be used with an external resistor or the internal jumpers. Contact Avocent Technical Support.
Pinout for RJ-45	Pin 1, ground. Pin 5, voltage input (from sensor to EVR1500 environmental monitor appliance). Pin 8, - +12 V output (from EVR1500 environmental monitor appliance to sensor).
Scale	Linear input required.
Digital Sensors	
Input Voltage	0 to 5 VDC.
Pinout	See <i>Appendix C</i> .

Appendix F: Technical Support

Our Technical Support staff is ready to assist you with any installation or operating issues you encounter with your Avocent product. If an issue should develop, follow the steps below for the fastest possible service:

1. Check the pertinent section of this manual to see if the issue can be resolved by following the procedures outlined.
2. Check our web site at www.avocent.com/support to search the knowledge base or use the on-line service request.
3. Call Avocent Technical Support for assistance at (888) 793-8763. Visit the Avocent web site at <http://www.avocent.com/support> and click on *Support Phone Numbers* for current phone support hours.

LIMITED WARRANTY

Avocent Corporation warrants to the original retail purchaser that this product is and will be free from defects in materials and workmanship for a period of 24 months from the date of purchase.

Additionally, all Avocent products carry an unconditional thirty-day satisfaction guarantee. If, for any reason, you are dissatisfied with the performance of this product, you may return it to the point of purchase for a refund of the purchase price (excluding shipping charges). This guarantee does not apply to special order products, and may not be available through all resellers. During the warranty period, purchaser must promptly call Avocent for a RETURN MATERIALS AUTHORIZATION (RMA) number. Make sure that the RMA number appears on the packing slip, proof of purchase, AND ON THE OUTSIDE OF EACH SHIPPING CARTON. Unauthorized returns or collect shipments will be refused.

Ship prepaid to: Avocent Corporation
4991 Corporate Drive
Huntsville, AL 35805 U.S.A.
Telephone: (256) 430-4000

The above limited warranty is voided by occurrence of any of the following events, upon which the product is provided as is, with all faults, and with all disclaimers of warranty identified below:

1. If defect or malfunction was caused by abuse, mishandling, unauthorized repair, or use other than intended.
2. If unauthorized modifications were made to product.
3. If unreported damages occurred in any shipment of the product.
4. If damages were due to or caused by equipment or software not provided by Avocent.
5. If the unit is used with non-grounded or incorrectly polarized AC power.
6. If the product is used in contradiction to any instruction provided by any User Guide or Instruction Sheet provided to you or with the product.
7. If the product is damaged due to power surges, water exposure or act of God including lightning.

EXCEPT AS SPECIFICALLY PROVIDED ABOVE AND TO THE MAXIMUM EXTENT ALLOWED BY LAW, AVOCENT CORPORATION DISCLAIMS ALL WARRANTIES AND CONDITIONS WHETHER EXPRESS, IMPLIED, OR STATUTORY AS TO ANY MATTER WHATSOEVER INCLUDING, WITHOUT LIMITATION, TITLE, NON-INFRINGEMENT, CONDITION, MERCHANTABILITY OR FITNESS FOR ANY PARTICULAR OR INTENDED PURPOSE.

EXCEPT AS EXPRESSLY PROVIDED ABOVE AND TO THE MAXIMUM EXTENT ALLOWED BY LAW, AVOCENT CORPORATION SHALL NOT BE LIABLE FOR ANY SPECIAL, INDIRECT OR CONSEQUENTIAL DAMAGES (INCLUDING WITHOUT LIMITATION, LOSS OF PROFIT, LOSS OF BUSINESS, LOSS OF INFORMATION, FINANCIAL LOSS, PERSONAL INJURY, LOSS OF PRIVACY OR NEGLIGENCE) WHICH MAY BE CAUSED BY OR RELATED TO, DIRECTLY OR INDIRECTLY, THE USE OF A PRODUCT OR SERVICE, THE INABILITY TO USE A PRODUCT OR SERVICE, INADEQUACY OF A PRODUCT OR SERVICE FOR ANY PURPOSE OR USE THEREOF OR BY ANY DEFECT OR DEFICIENCY THEREIN EVEN IF AVOCENT CORPORATION OR AN AUTHORIZED AVOCENT DEALER HAS BEEN ADVISED OF THE POSSIBILITY OF SUCH DAMAGES OR LOSSES.

©2004 Avocent Corporation. All rights reserved.



Avocent[®]

The Power of Being There.[®]

For Technical Support:

Email: support@avocent.com
www.avocent.com

Avocent Corporation
4991 Corporate Drive
Huntsville, Alabama 35805-6201 USA
Tel: +1 256 430 4000
Fax: +1 256 430 4031

Avocent Asia Pacific
Singapore Branch Office
100 Tras Street, #15-01
Amara Corporate Tower
Singapore 079027
Tel: +656 227 3773
Fax: +656 223 9155

Avocent Canada
50 Mural Street, Unit 5
Richmond Hill, Ontario
L4B 1E4 Canada
Tel: +1 877 992 9239
Fax: +1 877 524 2985

Avocent International Ltd.
Avocent House, Shannon Free Zone
Shannon, County Clare, Ireland
Tel: +353 61 715 292
Fax: +353 61 471 871

Avocent Germany
Gottlieb-Daimler-Straße 2-4
D-33803 Steinhagen
Germany
Tel: +49 5204 9134 0
Fax: +49 5204 9134 99

590-375-001B

KVM IP
OVER IP