

2U Rack mount 17" LCD keyboard drawer Via IP w/8 or 16-port PS/2 KVM

Model #: NVIP21782, NVIP217162

With IP KVM Features only:

- 8/16 port KVM over IP switch is 19" rack mount size design.
- Support DOS, Win3.X, Win95/98/98SE/2000/ME/SP, WinNT, Netware, Unix, Linux
- Support iMAC, Power MAC and Sun Microsystems with USB port (Need work with USB-PS/2 adapter)
- Hot Plug- Add PCs or Remove Connected PCs for Maintenance without Powering Down the KVM switch or PCs.
- High Video Quality- Resolution UP To 1920X1440 (local side), 1280X1024 (remote side)
- No Software Required-easy PC selection via On Screen Display Menu (OSD), Push Buttons, Hot Keys



- AT local console side-Support eight characters password protection and search PC server name
- At Remove console side-Use SSL protocol for any encrypted network traffic between itself and a connected client.
- Keyboard status restored when switching PCs
- LED Display for easy status monitoring
- Buzzer sound for switching port confirmation.
- Built-in one extra daisy chain port and no waste and PC port
- No DIP switch setting needed and auto detect daisy chain bank
- Manage servers around the world
- KVM (keyboard, video, mouse) access over IP and analogous telephone line.
- BIOS level access
- No impact on server or network performance
- Automatically senses video resolution for best possible screen capture
- High-performance mouse tracking and synchronization.

Specification

Monitor

Panel:	SAMSUNG 17" LCD panel
Display type:	TFT / LCD active matrix color
Resolutions:	1280 x 1024
Response time:	Tr=5ms/ Tf=20ms
Contrast ratio:	350 : 1 typical
Brightness:	250 cd/m2 typical
Pixel pitch:	0.264mm (H) x 0.264mm (W)
Panel color:	16.7 million display colors
Viewing angle:	150o (Horiz.)/ 125 o (Vert.)
Storage temp.	-25oC to 60 oC
Operating temp.	0 oC to 50 oC
MTBF	20,000 hours

Power supply

Remote adapter:	110V - 220V AC Input 12V 5A Output
Adapter Size:	4.3"(L) x 2.4" (W) x 1.2"(H) (108x61x30mm)
Cable length from mains plug to adapter:	6ft (182cm)
Cable length from adapter to unit:	6ft (180cm)

Product dimension--- 17.3"(W) x 1.75"(H) x 23.6"(D) (44.2x4.455x60cm)

Packing dimension--- 30.3"(L) x 23.6"(W) x 7.1"(H) (77x60x18cm)

Weight

Model No	KVM	Net / Gross weight
NVIP21782 (x)	8 port	39.6 lbs/ 52.8lbs (18kg/24kg)
NVIP217162 (x)	16 port	41.8 lbs/ 55.0lbs (19kg/25kg)

Keyboard Selection (x)

- "e" Notebook type keyboard with touch pad mouse
- "c" Cherry keyboard with trackball
- "b" Notebook type keyboard with three buttons trackball
- "d" Compact Keyboard integrated with three buttons trackball
- "t" Compact Keyboard integrated with touchpad mouse

Comes with:

- (1) NetView IP KVM Switches unit
- (8/16) 3-in-one PS/2 and VGA KVM cable, 6-feet (8/16ports)
- (1) Pair of mounting screws for rear extension mounting brackets
- (1) Power Adapter 110/220V
- (1) US Power cord
- (1) User Manual

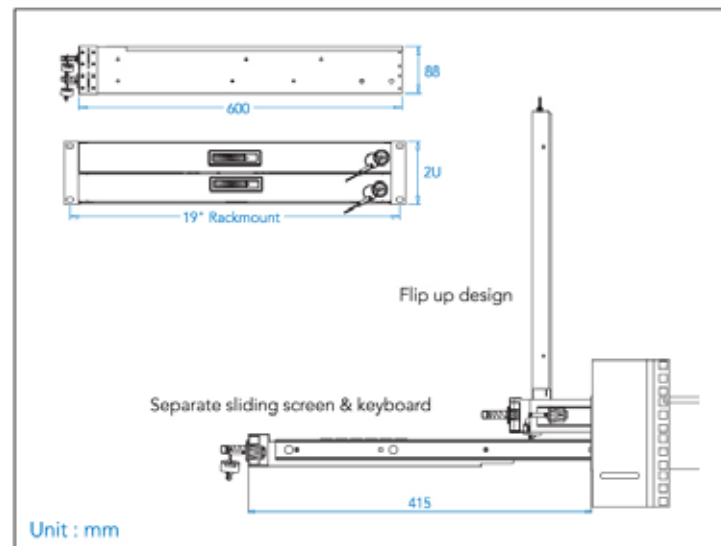

Rear view

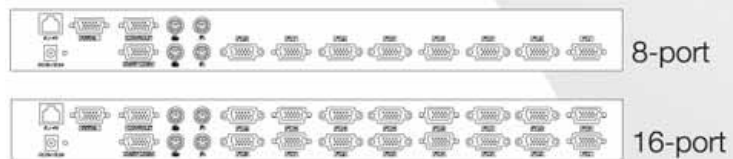

NETVIEW
KVM SWITCH SOLUTIONS