



Open Frame LCD Display, 10.1"-1920x1200, LED-350nits  
 VGA+DVI+HDMI signal input ports Projected capacitive  
 touch, RS232 interface, 3mm, with AR surface treatment  
 RS232 Remote Control Protocol: Command Code to set  
 system Integrated 9-36VDC power regulator with terminal  
 block OEM drawing **with optical Bonding**

**Model: EOPW1010B PCTR-ALT02-AR-OB**

**EOP Series:** EOP Series: Industrial Open Frame Metal Housing LCD Monitor (Optional for High Brightness and LED backlight)

**Features highlights:**



- Easy to Mount Open Frame, metal chassis (top & bottom flanges)
- Optional for Resistive/ Capacitive/ SAW/ IR/ Projective Capacitive Touch screen
- Auto Video Signal ON / OFF  
Auto Always Power On
- Side OSD buttons can prevent unnecessary setting changes.

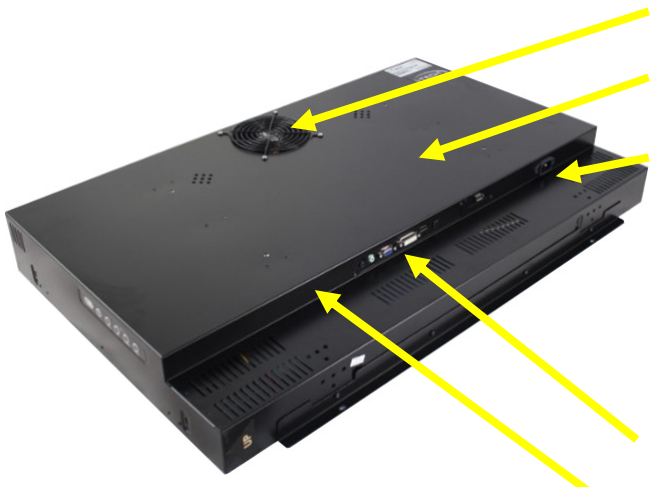

- Ultra low speed/Noise fan for extra cooling (24" LCD or above)
- VESA Mounting Hole Pattern
- Reliable built-in Power supply for 15" or above (Optional for 9-36V DC input)
- Standard VGA Input (Optional for DVI, HDMI, AV, BNC, AV looping and SDI)
- Optional for RS232 Remote Control Protocol: Command Code to set system



## Features:

- Modularize mechanical design provides flexible product configuration and easy maintenance
- VGA connector with optional AV,SV,AV-Looping
- Available with auto-brightness sensor offers application in day and night
- Optional build-in touch screen for interactive application
- Complete custom design/solution for OEM customers

## Specification:

<b>Panel</b>	Cell Type / Glass Surface	TFT LCD / Black Anti-Glare, low reflection coating	
	Aspect Ratio / Size	Wide / 10.1" viewable diagonal area	
	Active Area / Pixel Pitch	216.81(H) x 135.5(V) mm / 0.113(H) x 0.113(V) mm	
	Native Resolution / Colors	1920(H) x 1200(V) / 262 K	
	Brightness / Contrast	350 cd/m <sup>2</sup> (typ) / 600 : 1	
	Response Time	≤ 25 ms	
	Viewing Angle (typical)	H.160° (- 80° ~ + 80° ) , V. 160° (- 80° ~ + 80° )	
	Light Source	LED backlight, Long life, 35,000 hrs (typ)	
<b>Input Sources</b>	PC System	Signal	Analog RGB (0.7/1.0 V <sub>p-p</sub> , 75 ohms)
		Sync	Separate Sync, Composite Sync, Sync On Green
		Frequency	F <sub>h</sub> : 30 - 82Khz , F <sub>v</sub> : 50 -75Hz
	Audio System	N / A	
<b>Input Terminals</b>	1 x VGA (15 Pin Female D-Sub) , 1 x PC Audio (Stereo Headphone Jack) , 1 x DC Power Plug		
<b>Convenient Features</b>	Auto Calibration , Back Light Adjustment , Plug&Play (VESA DDC/CI, DDC 2B)		
	OSD Multi-Languages , Wall Mount Ready (VESA Dimension - please refer to Drawing)		
<b>Power</b>	12V DC in		
<b>Power Consumption</b>	Operation / Power Saving	8.75 watt , < 1 watt (Support DPMS)	
<b>Operating Condition</b>	Temperature / Humidity	0°C ~ 50°C (32°F ~ 122°F) , 10% ~ 90% (no condensation)	
<b>Storage Condition</b>	Temperature / Humidity	- 20°C ~ 60°C (- 4°F ~ 140°F) , 10% ~ 90% (no condensation)	
<b>MTBF</b>	50k hrs		
<b>Certification</b>	FCC , CE		
<b>Dimensions</b>	Physical	Please refer to Drawing	
	Carton	W x H x D = TBD	
<b>Weight</b>	N.W. / G.W.	3.5 Kgs / 4.5 Kgs	
<b>Container Loaded</b>	20ft / 40ft / 40ft HQ	TBD (Sets , By pallet)	

<b>Options</b>	Touch	Video / TV	Enhanced Panel	Others
	Resistive touch	SV + AV	Panel with LED backlight	Digital Signage(Stand alone)
	Capacitive touch	SV + AV + AV_Looping	High brightness panel	Networking Digital Signage
	SAW touch	SV + AV + TV	Wide Temperature	Motion Sensor
	Infrared touch		Sunlight Readable	Light Sensor
	Protected glass			Auto-Dimming

# Mechanical Drawing:

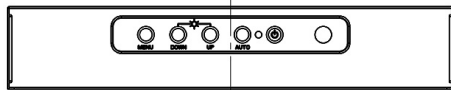
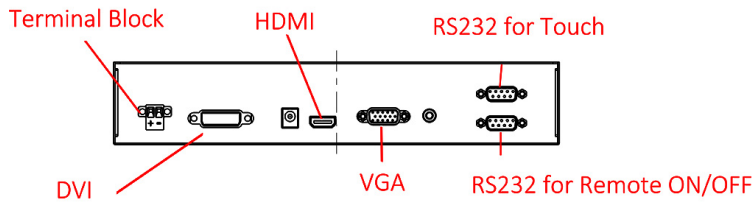
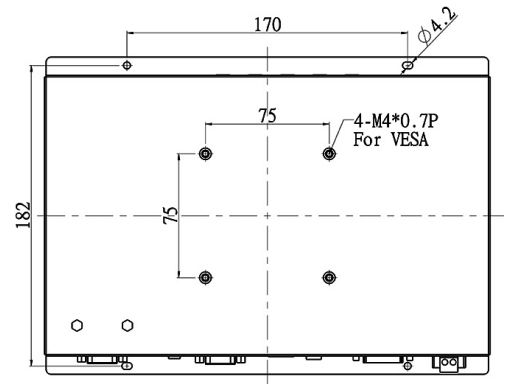
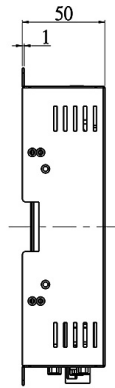
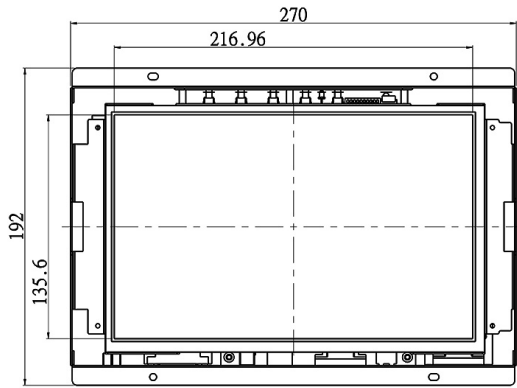

TOP VIEW

## LCD Options:



### LED Backlight Options

Introducing LED backlight options for monitors for energy efficiency and a brighter screen.



### TouchScreen Options

Our LCD has a wide selection option to choose which touchscreen technology suits for you.

	Four-Wire Resistive	Five-Wire Resistive	Pen Touch	Capacitive	Surface Wave(Saw)	Infrared Touch (Ir)
<b>PRODUCT SIZE</b>	1.7" - 24"	10.4" - 24"	15" - 19"	12" - 24"	10.4" - 30"	10.4" - 42"
<b>TOUCH LIFE</b>	1 - 2 million touches	30 - 35million touches	100 million touches	100 million touches	50 million touches	Long-term reliability
<b>SCRATCH RESISTANCE</b>	Hard Coated	Hard Coated	Hard Coated (SiO <sup>2</sup> )	Hard Coated (SiO <sup>2</sup> )	Glass Overlay Moh's hardness rating of 7	Glass Overlay Moh's hardness rating of 7
<b>CONTAMINANT RESISTANCE</b>	Resists moisture, dirt, vinegar, ammonia based food products and cleansers	Resists moisture, dirt, vinegar, ammonia based food products and cleansers	Resists moisture, dirt, vinegar, ammonia based food products and cleansers	Resists moisture, dirt, vinegar, ammonia based food products and cleansers	Resists moisture, dirt, vinegar, ammonia based food products and cleansers	Resists moisture, dirt, vinegar, ammonia based food products and cleansers
<b>INPUT METHOD</b>	Finger, Gloved Hand, Stylus	Finger, Gloved Hand, Stylus	Stylus Pen	Finger	Finger, Gloved Hand, Soft pliable stylus	Finger, Gloved Hand, Stylus
<b>CONTROLLER</b>	USB, RS232	USB, RS232	USB, RS232	USB, RS232	USB, RS232	USB, RS232



### VIDEO Input Options:

For Video inputs options:

DVI, DVI+HDMI, SVideo+AV, SVideo+AV+DVI, AV+Looping, DVI+AV+Looping, HD-SDI, BNC(PAL/NTSC)

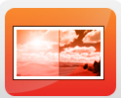

### Optical Bonding Options

- Optical Bonding provides the best reduction of ambient light washout of any commercially available enhancement technology.
- Optical Bonding has a lower cost than most other competing technologies.
- Optical Bonding offers superior ruggedization, enhancing the display durability under vibration, shock and other environmental extremes.



### RS-232 Remote Control Options

**Remote Control Protocol: Command Code to set system**



### 9-36V DC Input Options

iTech offers a selection of DC input from 9V to 36V



### Light Sensor and Motion Sensor Options

iTech LCD offers Light and Motion Sensor

### Privacy Filter

Front Glass Options:

- Anti Reflective AR Glass 3mm
- Anti Reflective AR Glass 6mm Vandal-Resistance
- Anti Reflective AR Glass 8mm Vandal-Resistance
- Anti Glare AG Glass 3mm



i-Tech Company LLC

TOLL FREE: (888) 483-2418 • EMAIL: [info@itechlcd.com](mailto:info@itechlcd.com) • WEB: [www.iTechLCD.com](http://www.iTechLCD.com)