TFT-LCD Digital Multivision

Ez-Video Wall Block

Product proposal



Copyright 2007 © i-Tech Company LLC. All rights reserved.

Free extendable 40" & 46" TFT-LCD Video Block

Ez-Video Wall Block shows what the most progressive solution of video wall and digital signage is. Ez-Video Wall Block's high resolution TFT-LCD display image, flexible screen configuration, free extendable block design and it's various image control software are ready to be applied to any innovative A/V system design. Ez-Video Wall Block will make imagination of System integrators come true.

General features

- **Resolution** : Up to 1900 x 1200(RGB), 1080p Full HD(DVI) input image receivable
- **Clean picture image** : Image compensation with Digital 3D Comb filter, ADC, Clamping, AGC, De-interlacing and Scaling, Edge smoothing, Object base DNR, Mosquito NR, MPEG block NR, Keystone, etc.
- **Free voltage (SMPS)** : 100 ~ 240 Volts
- **RS-232C control**
 - **Real** : Display input image sources on each screens
 - **Zoom** : Display one extended image over several screens
 - **Screen setting** : Color, Brightness, Contrast, etc.
 - **PIP, Aspect ratio(4:3 or 16:9), Text/Graphic mode, Sleep/Wake up, Volume control, Freeze**

Specifications

[TFT-LCD panel]

- LCD Driver element : 40 inch & 46 inch a-Si TFT active matrix
- Resolution : WXGA (1366x768 pixels)
- Display colors : 16.7M(8bits true) - Brightness : 700cd/m2
- Contrast Ratio : 1200:1 - Response time : 8ms
- Viewing Angle [,U/D/L/R] : 89/89/89/89

[Ez-Video Wall Block]

- Control : RS-232C
- Power consumption : 400W(40inch), 500W(46inch)
- I/O port : Input - BNC(Video) x 1, D-Sub 15p(RGB) x 1, DVI x 1, RS-232C x 1
Output - BNC(Video) x 1, D-Sub 15p(RGB) x 1, DVI x 1, RS-232C x 1
- Dimension(WxHxD) : 911.7mm x 524.2mm x 123.5mm (40inch), 1047.5mm x 600.6mm x 123.5mm (46inch)
- Weight(Approx) : 35Kg(40inch), 39Kg(46inch)
- Operating Temperature : 0 ~50
- Seam width (Between screen and screen) : 40inch - 21.5mm(L/R,U/D), 46inch - 24.5mm(L/R,U/D)
- Mounting type : Wall mount



[Ez-Video Wall Block] Dimensions of 40inch (46inch)

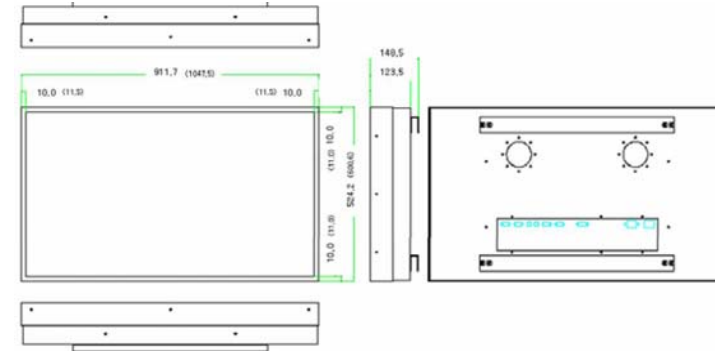

[Flexible Configuration and Free extension of Ez-Video Wall Block]

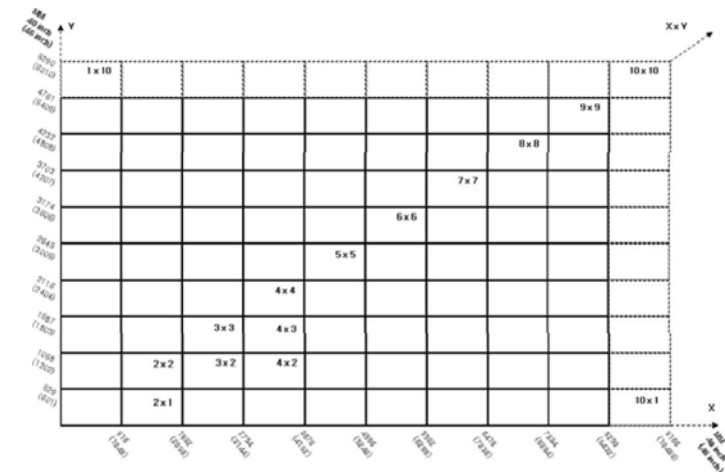

Ez-Video Wall Block Installation Procedure



Step 1 > Fix the Vertical Wall mount brackets on the wall with anchor bolts.

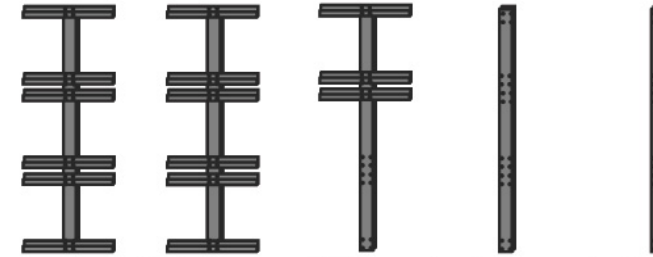

Step 2 > Assemble the Horizontal Wall mount brackets on to the fixed Vertical Wall mounts brackets with screws.

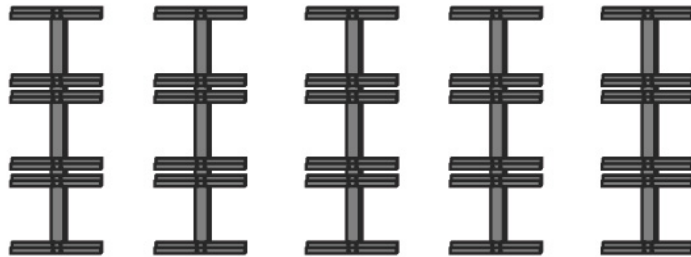

Step 3 > Measure degrees of the installed brackets' vertical and horizontal lines.

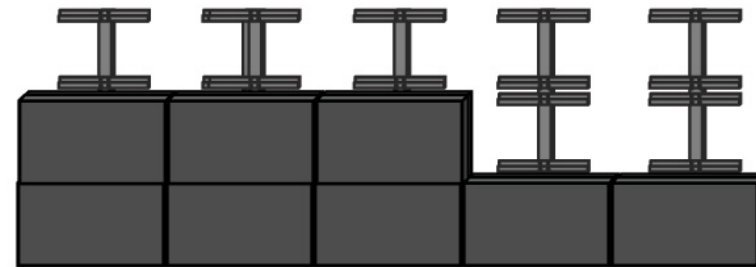

Step 4 > Hang Ez-Video Wall Blocks on the mounting brackets from the bottom lines

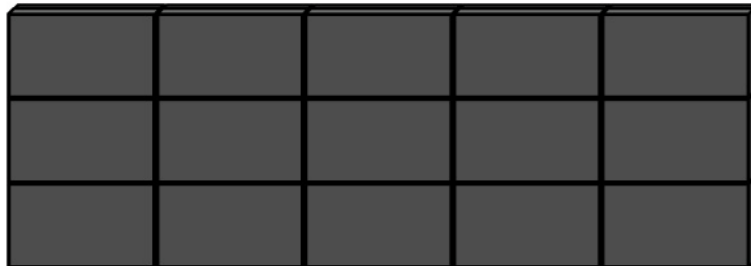

Step 5 > Wiring power and signal cables and then adjust column and row lines of screens.



Step 6 > Set input signals and image configurations with served control program.

Ez-Video Wall Block Wall mount bracket

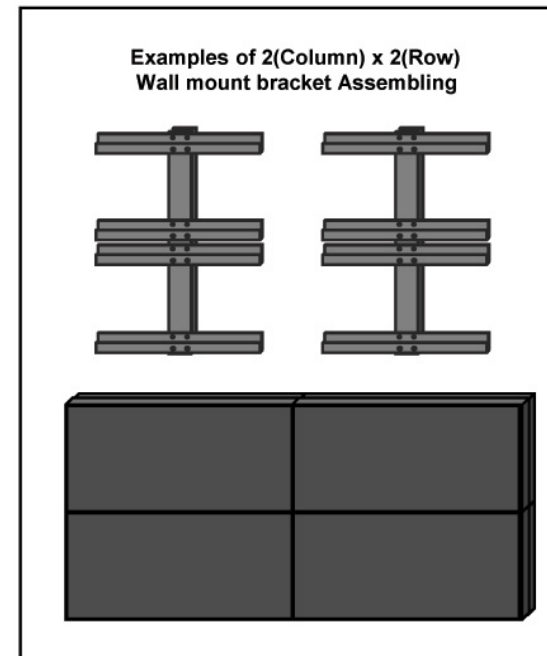
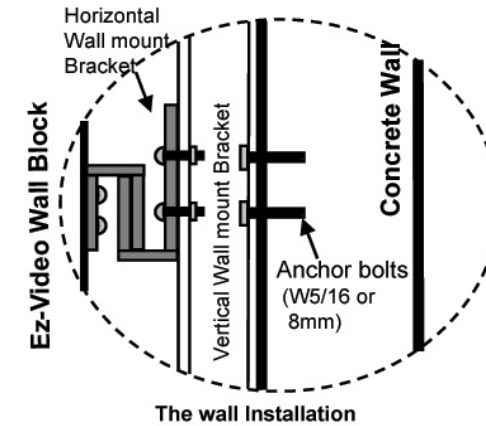
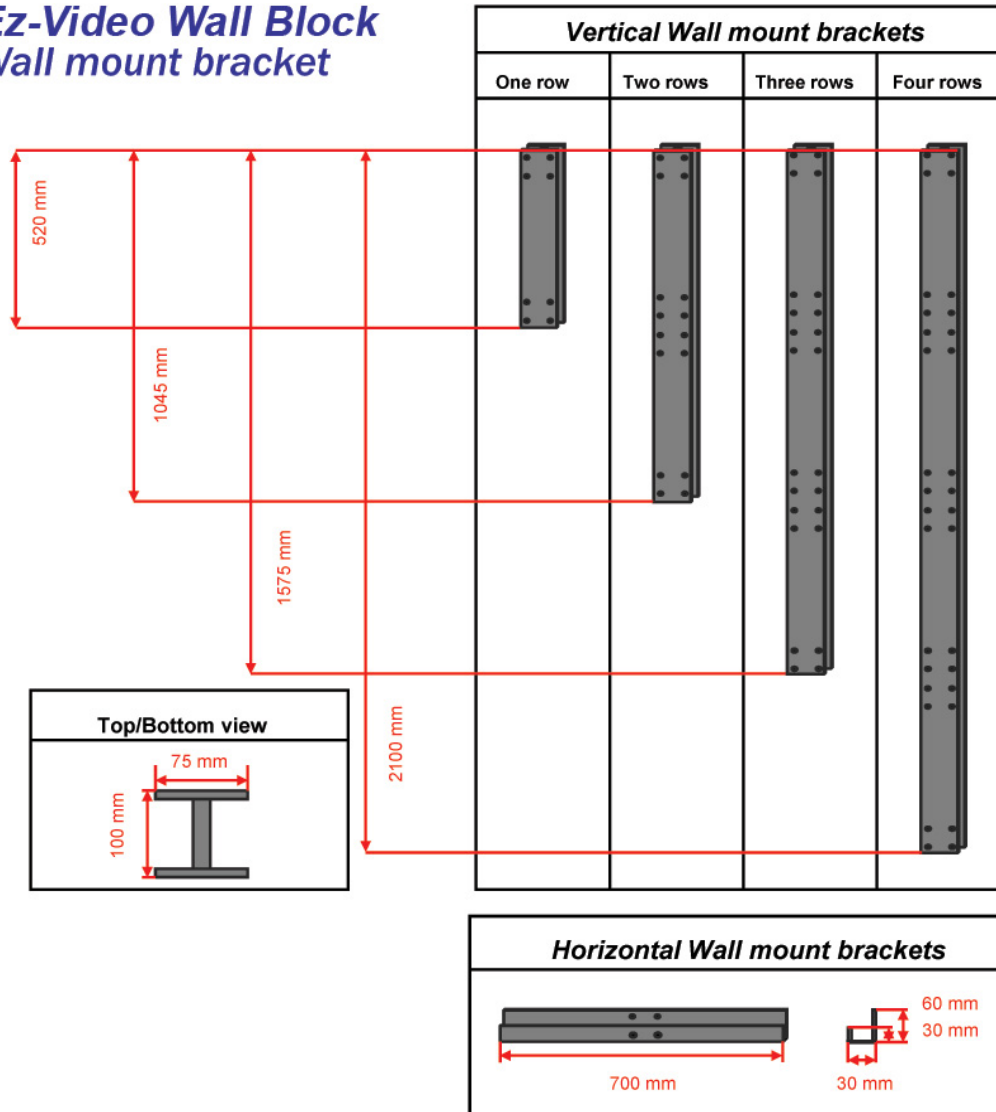

Ez-Video Wall Block Cabling diagram [RGB & Video Daisy Chain system]

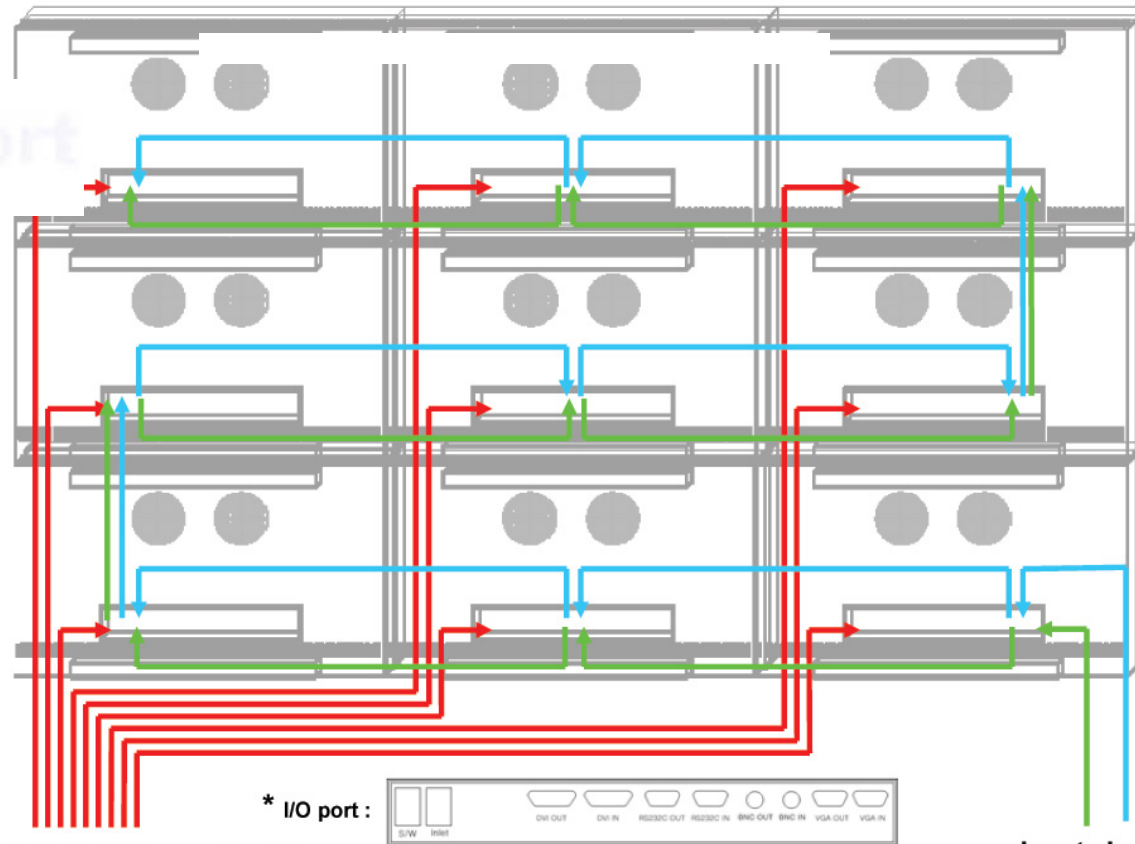

- RS-232C (Daisy Chain)
- RGB & Video (Daisy Chain)
- AC Power

Input signals

* RGB and Video signal Daisy Chain is available up to nine(9) screens without Matrix Switcher.

Ez-Video Wall Block Cabling diagram [Matrix Switcher system]

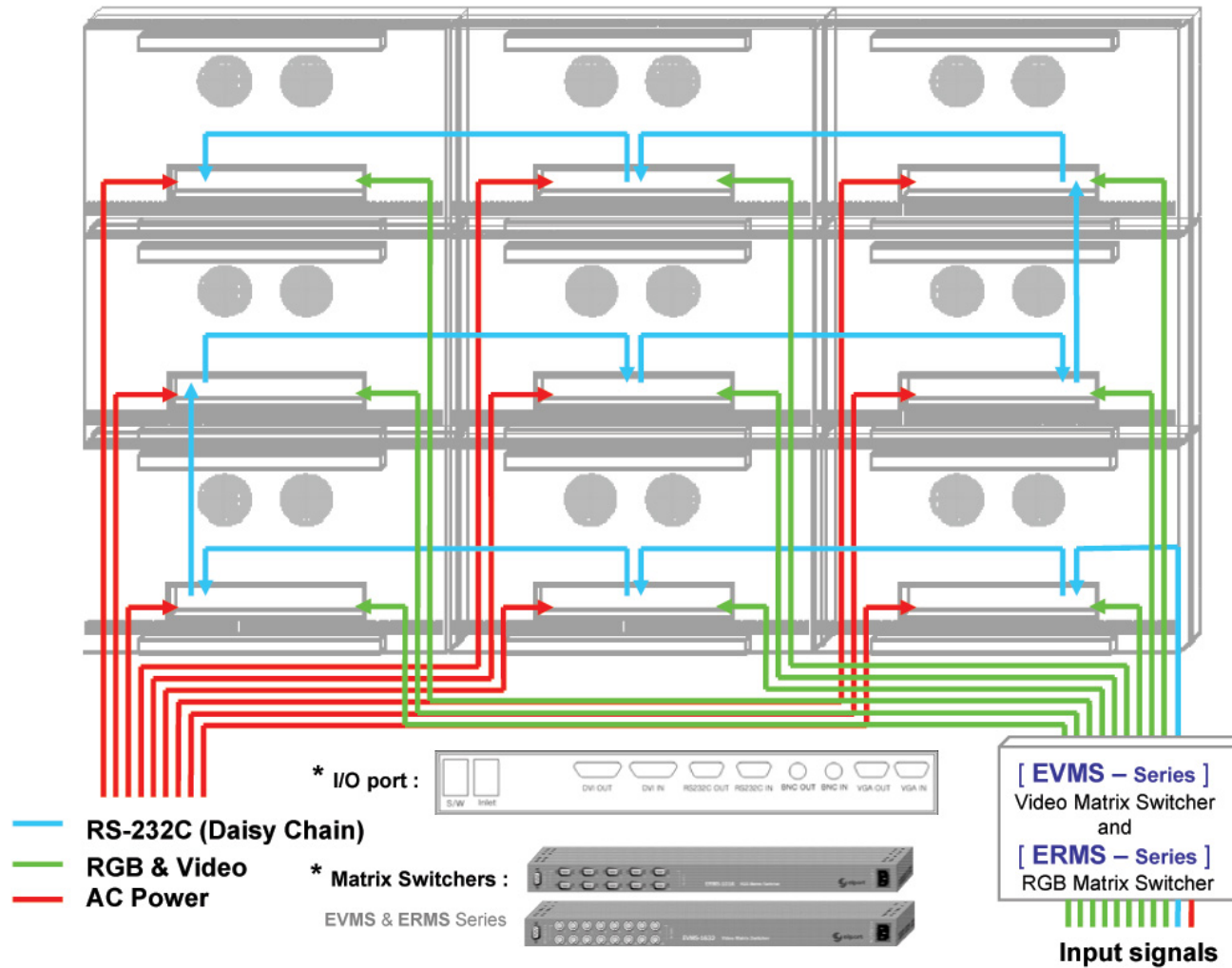

Ez-Video Wall Block

40 & 46 inch TFT-LCD Video Wall series

Digital Multivision Video Block

High brightness & Super Narrow bezel



Ez-Video Wall Block Control Program

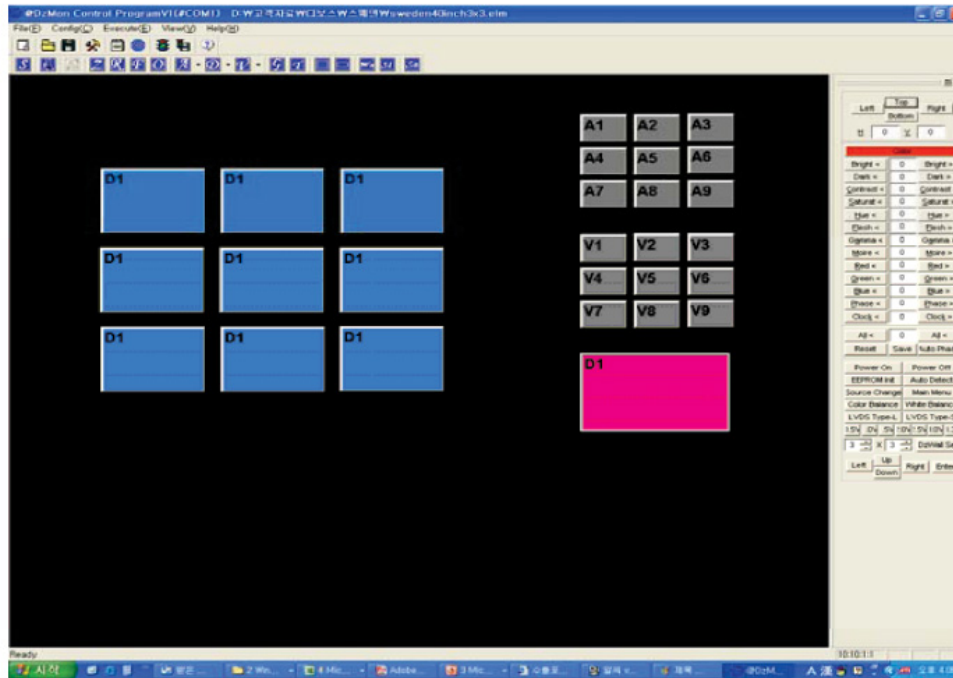

► Main tool menu :



Screen setting



Scenario setting



Screen value setting



Option setting

► Screen setting menu :



Send



Zoom



Real



Freeze on



Freeze off



VGA



DVI



Video



Save



Graphic mode



Text mode



Wake up



Sleep

Ez-Video Wall Block Front Access mechanism for Easy Maintenance

Ez-Video WallBlock has the most improved revolutionary mechanism of *the Pulling Window*. Every possible maintenance (screen & cable setting, changing circuit boards, changing cables, changing LCD screen, etc.) can be done from the front simply by opening the LCD screen. *The Pulling Window* has one touch locking mechanism so user can open and close the screen without tools.

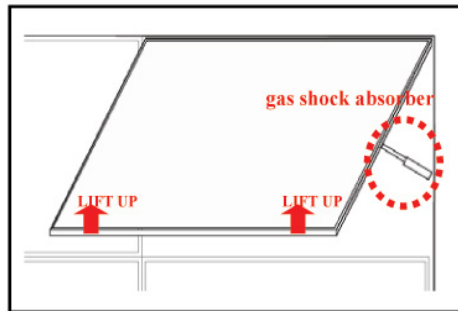
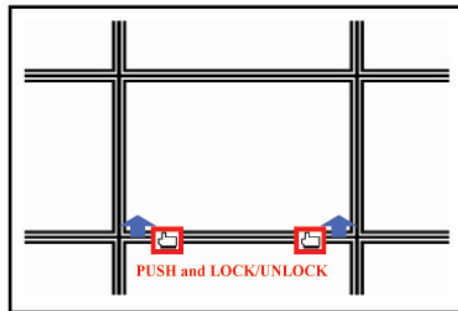

Matrix Switcher Packages [EVMS & ERMS Series]

ERMS - Series RGB Matrix Switcher

Mount type	Model Name	Number of Inputs	Number of Outputs
Slim type	ERMS – 1010	10	10
	ERMS – 1016	10	16
	ERMS – 0426	4	26
Rack type	ERMS – 1616	16	16
	ERMS – 1632	16	32
	ERMS – 1648	16	48

ERMS - Series RGB Matrix Switcher



EVMS - Series Video Matrix Switcher

Mount type	Model Name	Number of Inputs	Number of Outputs
Slim type	EVMS – 1010	10	10
	EVMS – 1616	16	16
	EVMS – 2626	26	26
Rack type	EVMS – 6464	64	64
	EVMS – 8080	80	80
	EVMS – Max	256	256

EVMS - Series Video Matrix Switcher

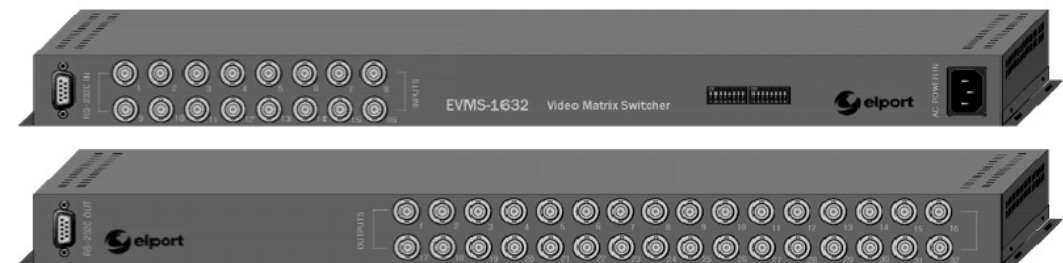

* **Slim type** Matrix Switchers are designed to be installed at the rear of Ez-Video Wall Block



i-Tech Company LLC

- **TOLL FREE: (888) 483-2418**
- **EMAIL: info@i-techcompany.com**
- **WEB: www.i-techcompany.com**

Thank you!