

SPECIFICATION APPROVAL SHEET

Open Frame 17" (1280x1024) Digital TFT LCD, Aspect Ratio: 4:3
Input Signal VGA / DVI-D / HDMI 1.3a, Maximum Support Resolution
1920x1080, Stereo Audio Amplifier, Output 2W@4Ω Speaker, Audio Line-In
5 Key Buttons Controls, 5 Wires Resistive Touch Panel
9 Language OSD Menu, LED Backlight, Wide Operation Voltage +11V~28V
No cables, no accessories, no Power adapter.

MODEL: FCOP1700-TR



i-Tech Company LLC

TOLL FREE: (888) 483-2418 • EMAIL: info@itechlcd.com • WEB: www.iTechLCD.com



1. General Description

1.1 Features

- 17" (1280x1024) Digital TFT LCD
- Aspect Ratio: 4:3
- Input Signal VGA / DVI-D / HDMI 1.3a
- Maximum Support Resolution 1920x1080
- Stereo Audio Amplifier, Output 2W@4Ω Speaker
- Audio Line-In
- 5 Wires Resistive Touch Panel
- 5Key Buttons Controls
- 9 Language OSD Menu
- LED Backlight
- Wide Operation Voltage +11V~28V

1.2 Applications

- Industrial
- Medical Environment
- Instrument Display
- Kiosk
- Security
- Signage
- Office Electronics
- Home Application
- Educate Application



2. Contents

Contents	Page
1. General Description	1
1.1 Features	1
1.2 Applications	1
2. Contents	2-3
3. Specifications	4
4. Block Diagram	4
5. Order Information	5
5.1 Unit	5
6. Accessories (Option)	6
7. Operation manual / Connection	7
7.1 Driver Board Manual	7
8. Pin Description	8-12
8.1 J103 : Pin Assignment of Power Input (DC Jack Inside Diameter:2.1 ϕ Outside Diameter:5.5 ϕ Side Entry Type)	8
8.2 J702 : Pin Assignment of UART (Pitch 1.25mm 4Pin, Top Entry Type)	8
8.3 J503 : Pin Assignment of Analog RGB Input (D-Sub 15Pin)	8
8.4 J401 : Pin Assignment of DVI-D (24 Pin)	9
8.5 J402 : Pin Assignment of HDMI-A Type Input (HDMI 1.3a -19Pin Female)	10
8.6 J602A : Pin Assignment of Key Board (Pitch 1.25mm 12Pin , Side Entry Type)	10
8.7 J303 : Pin Assignment of Speaker Left (Pitch 2.0mm 2Pin , Top Entry Type)	11
8.8 J302 : Pin Assignment of Speaker Right (Pitch 2.0mm 2Pin , Top Entry Type)	11
8.9 J701 : Pin Assignment of Touch USB (USB A Type - Female 2.0mm, Side Entry Type)(Option)	11
8.10 J705 : Pin Assignment of Touch RS232 (D-Sub 9 Female)(Option)	11
8.11 J301 : Pin Assignment of Line-In/Ear Phone (Option) (Outside Diameter:3.5 ϕ Side Entry Type)	12
9. Absolute Maximum Ratings	12
9.1 Absolute Maximum Ratings	12
10. Recommended Operating Conditions	12-13
10.1 Electrical Characteristics	12
10.2 VGA Mode Characteristics	13
11. 5W Resistive Touch Panel Characteristics	13-16
11.1 Electrical Performance	13
11.2 Optical Performance	13
11.3 Mechanical Performance	13
11.4 Durability Performance	13
11.5 5W Resistive Touch Panel Operation System Support	14
11.6 Resistive Touch Panel Integration Design Guide	15
11.7 Mechanical Design Notice For Resistive Touch Panel	16



12. Key Function by OSD.....	17-20
12.1 Menu Operation	17-20
13. Dimension Information.....	21-23
7.1 Unit (FCOP1700-TR)	21
14. Appendix.....	22
14.1 TFT-LCD Mechanical Specifications	22
14.2 TFT-LCD Optical Characteristics	22
15. Revision History.....	23
15.1 Record of Revision	23

3. Specifications

LCD	
Panel Size	17"
Resolution (Pixels)	1280x1024
Color	16.7M
Luminance without TP	250 cd/m ²
Luminance (RTP)	200 cd/m ²
Contrast Ratio	1000
View Angle	85 / 85 / 80 / 80
LED Life Time	50K (Min)
Power Requirement	
Power Input (DC Jack 2.5 φ)	+11 ~ +28Vdc
Power Consumption@+12V	11 Watts (@Without Amplifier)
Touch Screen	
Resistive Type	5W(USB / RS232 Interface)
Resistive Type Support OS	Windows / Linux / DOS / Mac / QNX

Input Signal			
VGA	D-Sub15		
DVI	DVI-D		
HDMI	1.3a		
Audio			
Amplifier	1W@8Ω / 2W@4Ω		
Line-In	Stereo Input Phone Jack φ 3.5		
Controls			
Key	5 Buttons		
Serial Remote Control	UART / RS232 (Option)		
Environment			
Temperature Range	Without TP	5W RTP	
	Operating	0 ~ +50℃	0 ~ +50℃
	Storage	-20 ~ +60℃	-20 ~ +60℃
High Temperature & High Humidity (Non-condensing)	Operating	+40℃ / 90%	+40℃ / 90%

4. Block Diagram

4.1 Block Diagram

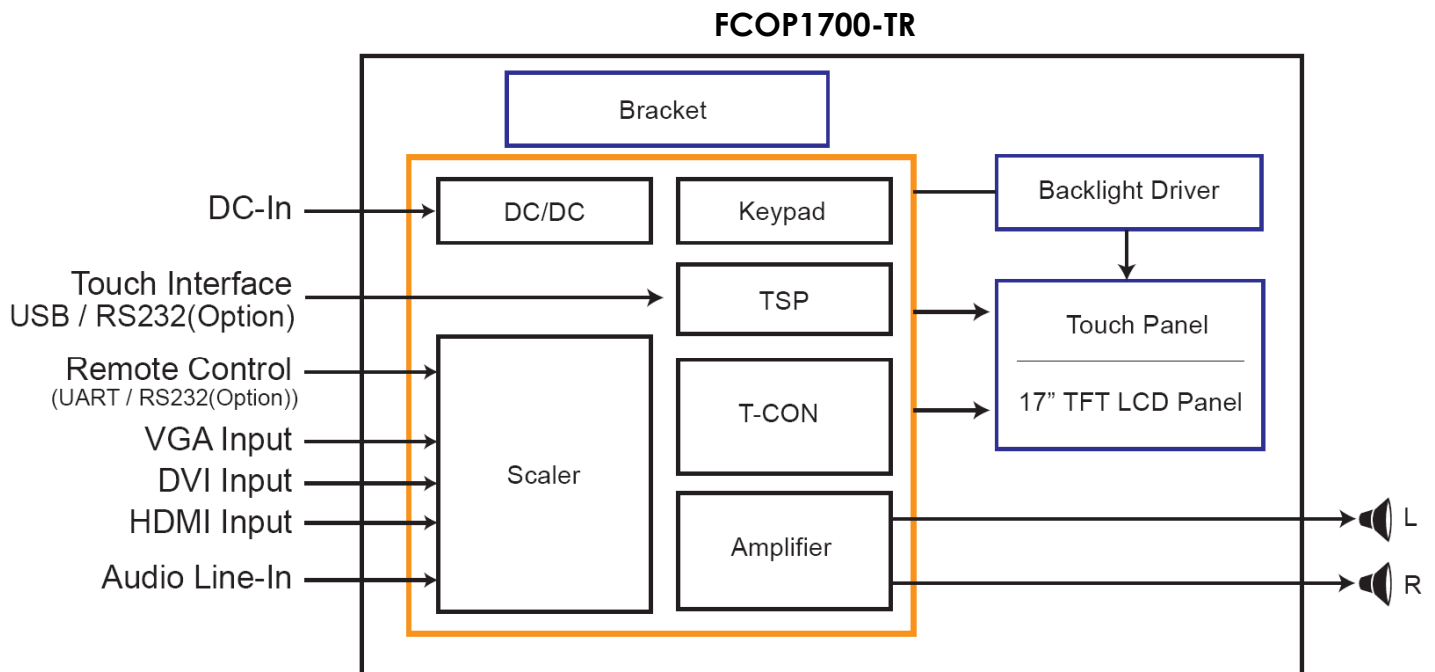



5. Order Information

5.1 Unit

Parameter	FCOP1700-TR			Unit	Remark
VGA	⊙				
DVI	⊙				
HDMI	⊙				
Touch Panel Type	5W Resistive				
Touch Screen Interface	USB				
Audio Amplifier	⊙				
Audio Line-In	⊙				
5 Keys	⊙				
Dimensions	378.7 x 298.4 x 34.62			mm	
Weight	3.3			Kg	±10%
Condition	Standard				

Note: 1. The assembling of panel and bracket is aimed for delivery, packaging and experiment. If the demand of shockproof and long-term fix, pls have it into consideration of mechanism design.

Parameter	Condition
Ear Phone	Customized
RS232 Remote Control	
UART Remote Control	
Back Cover	
External Key	
Light Sensor	

Note: Special order condition will apply to non-standard items and pls contact salespersons in iTech.

6. Accessories (Option)

Before you begin installing the KIT, please make sure that the following materials have been shipped:

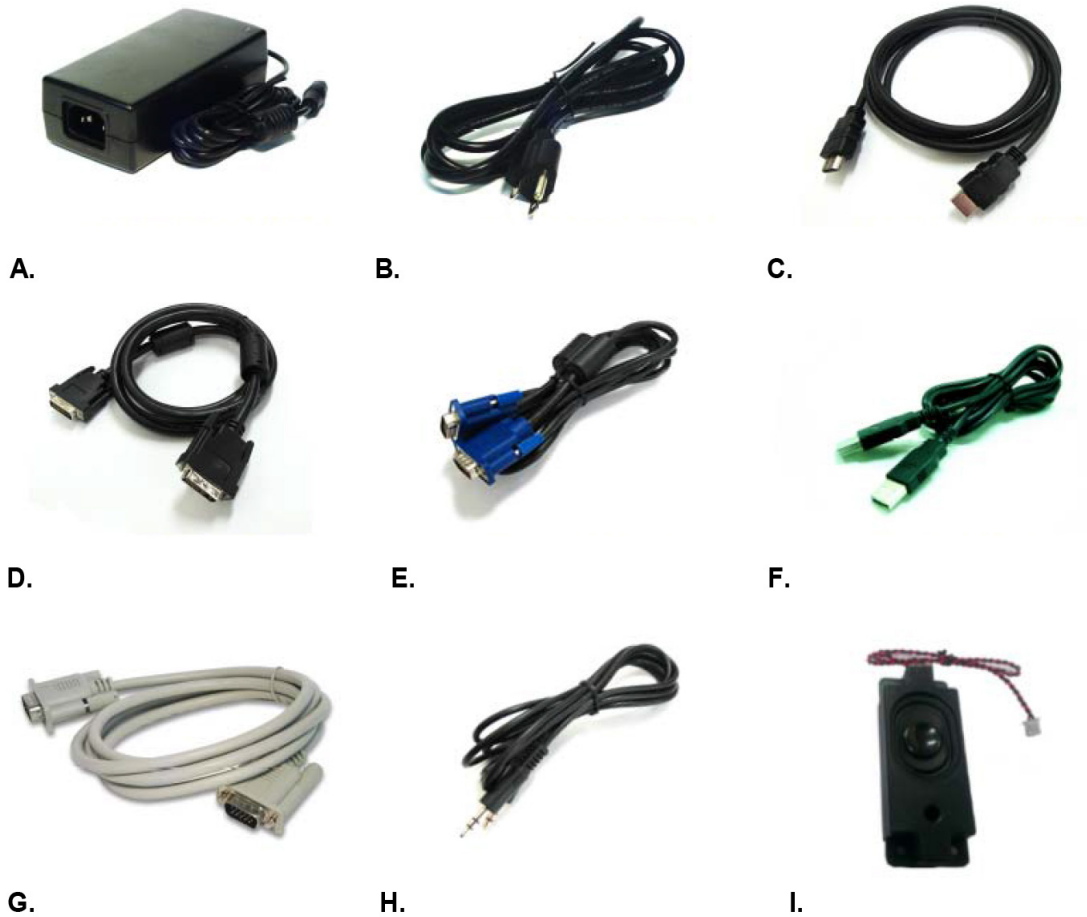

- A. AC to DC Adapter (L:1500mm,100-240V_{AC} 50-60Hz to +12V_{DC} @ 5A, ϕ 2.5)
- B. Power Cord (L:1800mm, Plug Type B for USA)
- C. HDMI Cable (L:1800mm)
- D. DVI Cable (L:1800mm)
- E. VGA Cable (L:1800mm)
- F. USB Cable (L:1800mm)
- G. RS232 Cable (L:1800mm, Null Modem)
- H. AUDIO Cable (L:1800mm)
- I. Touch Screen Driver CD Disk / User Manual
- J. Speaker (2.5W @ 4 Ω L:400mm *2 Pieces)

7. Operation manual / Connection

7.1 Driver Board Manual

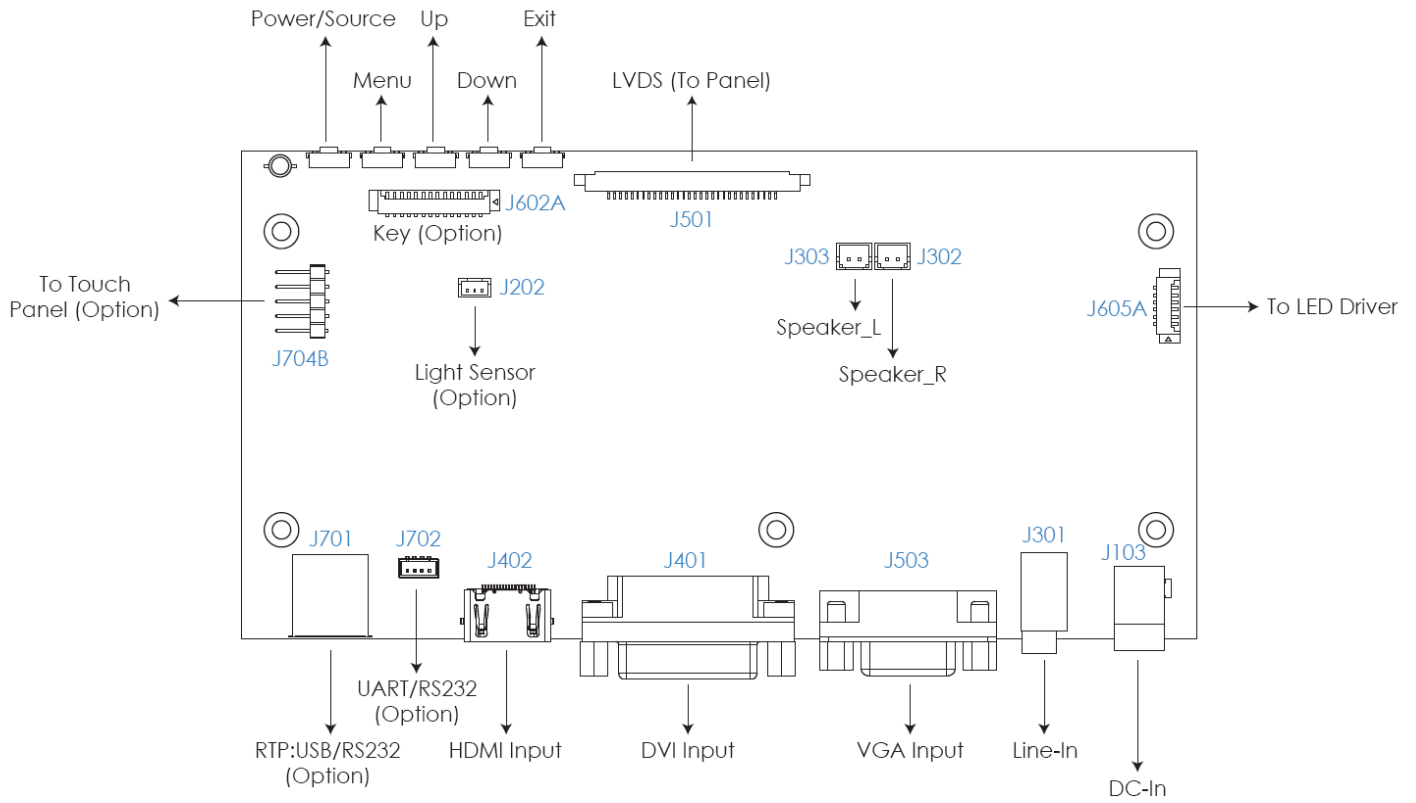

8. Pin Description

8.1 J103 : Pin Assignment of Power Input (DC Jack Inside Diameter:2.5 φ Outside Diameter:5.5 φ Side Entry Type)

Pin No.	Symbol	I/O	Description	Remark
1	DC-IN	I	+11~+28 Vdc Input Voltage	
2	GND	-	Power Ground	

8.2 J702 : Pin Assignment of UART (Pitch 1.25mm 4Pin, Top Entry Type)

※ Connector Part No.: MS24014 (STM) [Same as 53398-0471 (MOLEX)] ;

※ Matching Connector Part No.: P24014 (STM) [Same as 51021-0400 (MOLEX)].

Pin No.	Symbol	I/O	Description	Remark
1	TX / RS232 TX (Option)	O	UART / RS232 (Option) Transmission Data	
2	RX / RS232 RX (Option)	I	UART / RS232 (Option) Receive Data	
3	GND	-	Ground	
4	+3.3Vdc	O	+3.3V Output Voltage	

Note: All Functions can be controlled by UART , About UART command list please contact iTech sales.

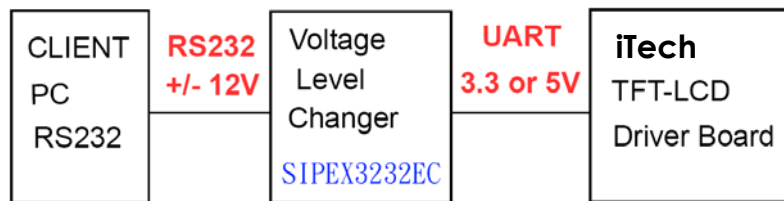

8.3 J503 : Pin Assignment of Analog RGB Input (D-Sub 15Pin)

Pin No.	Symbol	I/O	Description	Remark
1	RI+	I	Analog Red Signal	
2	GI+	I	Analog Green Signal	
3	BI+	I	Analog Blue Signal	
4	GND	-	Ground	
5	VGA-Det	I	VGA Detect	
6	AGND	-	Analog Ground	
7	AGND	-	Analog Ground	
8	AGND	-	Analog Ground	
9	VGA5V	-	VGA +5V Input	
10	GND	-	Ground	
11	GND	-	Ground	
12	VGA_SDA	-	DDC2 Data	
13	HS_IN	I	TTL Horizontal sync.	
14	VS_IN	I	TTL Vertical sync.	
15	VGA_SCL	-	DDC2 Clock	

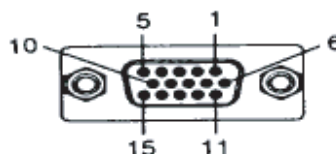

8.4 J401 : Pin Assignment of DVI-D (24 Pin)

Pin No.	Symbol	I/O	Description	Remark
1	DATA2-	I	Negative DVI Input for A Link Data Channel 2	
2	DATA2+	I	Positive DVI Input for A Link Data Channel 2	
3	GND	-	Ground	
4	NC	-	No Connection	
5	NC	-	No Connection	
6	DVI_SCL	I	DDC2 Clock	
7	DVI_SDA	I	DDC2 Data	
8	NC	-	No Connection	
9	DATA1-	I	Negative DVI Input for A Link Data Channel 1	
10	DATA1+	I	Positive DVI Input for A Link Data Channel 1	
11	GND	-	Ground	
12	NC	-	No Connection	
13	NC	-	No Connection	
14	DVI5V	I	DVI +5V Input	
15	DET_DVI	I	DVI Detect	
16	DVI_HPD	-	Hot Plug Detect	
17	DATA0-	I	Negative DVI Input for A Link Data Channel 0	
18	DATA0+	I	Positive DVI Input for A Link Data Channel 0	
19	GND	-	Ground	
20	NC	-	No Connection	
21	NC	-	No Connection	
22	GND	-	Ground	
23	DCLK+	I	Positive DVI Input for A Link Clock Channel	
24	DCLK-	I	Negative DVI Input for A Link Clock Channel	

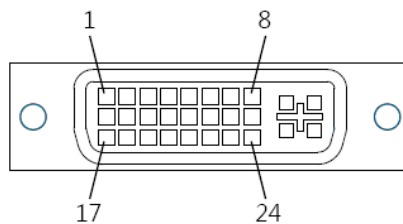

8.5 J402 : Pin Assignment of HDMI-A Type Input (HDMI 1.3a -19Pin Female)

Pin No.	Symbol	I/O	Description	Remark
1	DATA2+	I	Positive HDMI Input for B Link Data Channel 2	
2	DET_HDMI	-	HDMI Detect	
3	DATA2-	I	Negative HDMI Input for B Link Data Channel 2	
4	DATA1+	I	Positive HDMI Input for B Link Data Channel 1	
5	GND	-	Ground	
6	DATA1-	I	Negative HDMI Input for B Link Data Channel 1	
7	DATA0+	I	Positive HDMI Input for B Link Data Channel 0	
8	GND	-	Ground	
9	DATA0-	I	Negative HDMI Input for B Link Data Channel 0	
10	DCLK+	I	Positive HDMI Input for B Link Clock Channel	
11	GND	-	Ground	
12	DCLK-	I	Negative HDMI Input for B Link Clock Channel	
13	NC	-	No Connection	
14	NC	-	No Connection	
15	HDMI_SCL	I	DDC2 Clock	
16	HDMI_SDA	I	DDC2 Data	
17	GND	I	DDC/CEC Ground	
18	HDMI5V	I	HDMI +5V Input	
19	HDMI_HPD	I	Hot Plug Detect	

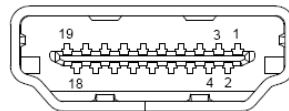

8.6 J602A : Pin Assignment of Key Board (Pitch 1.25mm 12Pin , Side Entry Type)(Option)

※ Connector Part No.: MS240112R (STM) [Same as 53261-1219 (MOLEX)] ;

※ Matching Connector Part No.: P240112 (STM) [Same as 51021-1200 (MOLEX)].

Pin No.	Symbol	I/O	Description	Remark
1	-	-	Don't Connect	
2	SW5	I	EXIT	
3	SW4	I	DOWN	
4	SW3	I	UP	
5	SW2	I	MENU / S	
6	SW1	I	POWER / SOURCE	
7	GND	-	Ground	
8	VDDP	-	VDDP +3.3V Output Voltage	
9	-	-	Don't Connect	
10	RED	O	Indicator red LED for power off control	
11	GREEN	O	Indicator green LED for power on control	
12	GND	-	Ground	

8.7 J303 : Pin Assignment of Speaker Left (Pitch 2.0mm 2Pin , Top Entry Type)

※ Connector Part No.: A2001WV2-2P(JWT) ;

※ Matching Connector Part No.: A2001H02-2P(JWT) .

Pin No.	Symbol	I/O	Description	Remark
1	+LOUT	O	Left Speaker Out+	
2	-LOUT	O	Left Speaker Out -	

8.8 J302 : Pin Assignment of Speaker Right (Pitch 2.0mm 2Pin , Top Entry Type)

※ Connector Part No.: A2001WV2-2P(JWT) ;

※ Matching Connector Part No.: A2001H02-2P(JWT) .

Pin No.	Symbol	I/O	Description	Remark
1	+ROUT	O	Right Speaker Out+	
2	-ROUT	O	Right Speaker Out-	

8.9 J701 : Pin Assignment of Touch USB (USB A Type - Female 2.0mm, Side Entry Type)(Option)

Pin No.	Symbol	I/O	Description	Remark
1	VBUS	-	USB VCC	
2	D-	-	DATA (-)	
3	D+	-	DATA (+)	
4	DGND	-	Digital Ground	

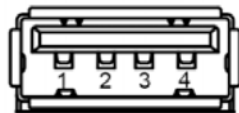

8.10 J705 : Pin Assignment of Touch RS232 (D-SUB 9 male)(Option)

Pin No.	Symbol	I/O	Description	Remark
1	-	-	Don't Connect	
2	RXD	I	Receive Data	
3	TXD	O	Transmit Data	
4	-	-	Don't Connect	
5	GND	-	Ground	
6	NC	-	No Connection	
7	NC	-	No Connection	
8	-	-	Don't Connect	
9	-	-	Don't Connect	

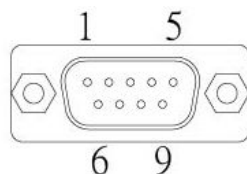

8.11 J301 : Pin Assignment of Line-In/Ear Phone (Option) (Outside Diameter:3.5 φSide Entry Type)

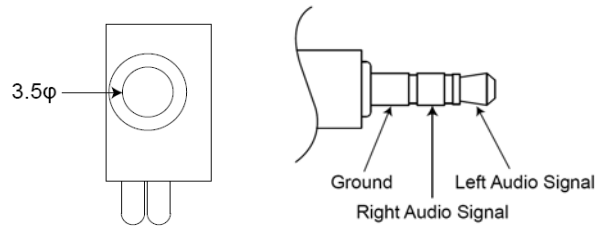

9. Absolute Maximum Ratings

9.1 Absolute Maximum Ratings

Parameter	Symbol	Min	Max	Unit	Remark
Input Voltage	Vin	10.5	28.5	V	
Analog RGB Input Signal	Analog RGB in	0.5	2.0	Vp-p	
Digital Input Signal	TTL	0.3	3.6	V	
DVI Input Signal		-	165	MHz	
HDMI Input Signal		-	165	MHz	
Line-in		-	1.8	Vp-p	
Operating Temp. without TP		0	+50	°C	
Storage Temp. without TP		-20	+60	°C	
Operating Temp. 5W RTP		0	+50	°C	
Storage Temp. 5W RTP		-20	+60	°C	
High Temperature & High Humidity (Non-condensing) without RTP		-	+40 / 90	°C / %	
High Temperature & High Humidity (Non-condensing) 5W RTP		-	+40 / 90	°C / %	

10. Recommended Operating Conditions

10.1 Electrical Characteristics

Parameter	Symbol	I/O	Min	Typ	Max	Unit	Note
Input Voltage	DC-in	I	+11	12	+28	V	
Total Current	I-in	I	-	1400	-	mA	+12V
Power Consumption		I	-	17	-	W	±15% @Without Amplifier
Output Voltage	VDD	O	3.2	3.3	3.4	V	
Analog RGB Input Signal	Analog RGB in	RGB	I	0.7	-	Vp-p	@75Ω
DVI Input Signal			-	-	165	MHz	
HDMI Input Signal			-	-	165	MHz	



10.2 VGA Mode Characteristics

Dots per inch	H	Unit	Polarity	V	Unit	Polarity	Note
640 x 480	31.47	KHz	Positive	59.9	Hz	Positive	
800 x 600	37.88	KHz	Positive	60.3	Hz	Positive	
1024 x 768	48.36	KHz	Positive	60	Hz	Positive	
1280 x 1024	63.98	KHz	Positive	60	Hz	Positive	
1600 x 1200	75	KHz	Positive	60	Hz	Positive	
1920 x 1080	67.5	KHz	Positive	60	Hz	Positive	

11. 5W Resistive Touch Panel Characteristics

11.1 Electrical Performance

Parameter	Symbol	Min	Typ	Max	Unit	Note
Terminal Resistance	X	20	-	500	Ω	
	Y	20	-	500	Ω	
Linearity		-	-	1.5	%	
Insulation Impedance		20	-	-	M Ω	DC 25V
Response Time		-	-	10	ms	

11.2 Optical Performance

Parameter	Specifications
Light Transmittance	80% \pm 5%
Haze	< 15%

11.3 Mechanical Performance

Parameter	Specifications
Input Method	Stylus or Finger
Operating Force	R8 Silicon Rubber,60HS
Surface Hardness	3H pencil, pressure 1N/45°

11.4 Durability Performance

Parameter	Specifications
Knock Test	10,000,000 times



11.5 Resistive Touch Panel Operation System Support

Driver Vender : EETI (eGalax_eMPIA Technology Inc.)

OS	Version	Interface
Windows	Windows XP Embedded	RS232/USB
	Windows Vista, XP, 2000	
	Windows Embedded POSReady 2009	
	Windows Embedded 7, 8	
	Windows 7, 8, 8.1, 10	
Windows CE	Windows CE.Net (4.x / 5.0)	RS232/USB
	Windows CE 6.0	
	Windows Embedded Compact 7	
	Windows Embedded Compact 2013	
Linux	Kernel 2.4.x (x86)	USB
	Kernel 2.6.23 Downward (X86)	
	Kernel 2.6.24 Upward and 3.x.x (X86 / ARM / MIPS)	
Android	Android Version 2.3.x upwards (X86 / ARM / MIPS)	USB
Mac OS	Mac OS X 10.5.3 Leopard (Power PC)	USB
	Mac OS X 10.7.4 Earlier (32Bit) (Intel CPU)	
	Mac OS X 10.7.4 Earlier (64Bit) (Intel CPU)	
	Mac OS X 10.7.5 (32Bit) (Intel CPU)	
	Mac OS X 10.7.5 (64bit) (Intel CPU)	
	Mac OS X 10.8.x Mountain Lion (Intel CPU)	
	Mac OS X 10.9.x Mavericks (Intel CPU)	
	Mac OS X 10.10.x Yosemite (Intel CPU)	
QNX	QNX RTOS V6.3	USB
	QNX Neutrino RTOS V6.5/6.4	
DOS	DOS	PS2

Note: 1. How to use Touch Driver, please refer to Readme of Touchkit Disk.

2. Please refer to the iTech website for the latest driver version and support operating system.

iTech website: <http://www.itechlcd.com>

11.6 Resistive Touch Panel Integration Design Guide

Avoid the design that Front-case overlap and press on the active area of the touch-panel.

Give enough gap (over 0.5mm at compressed) between the front case and touch-panel to protect wrong operating.

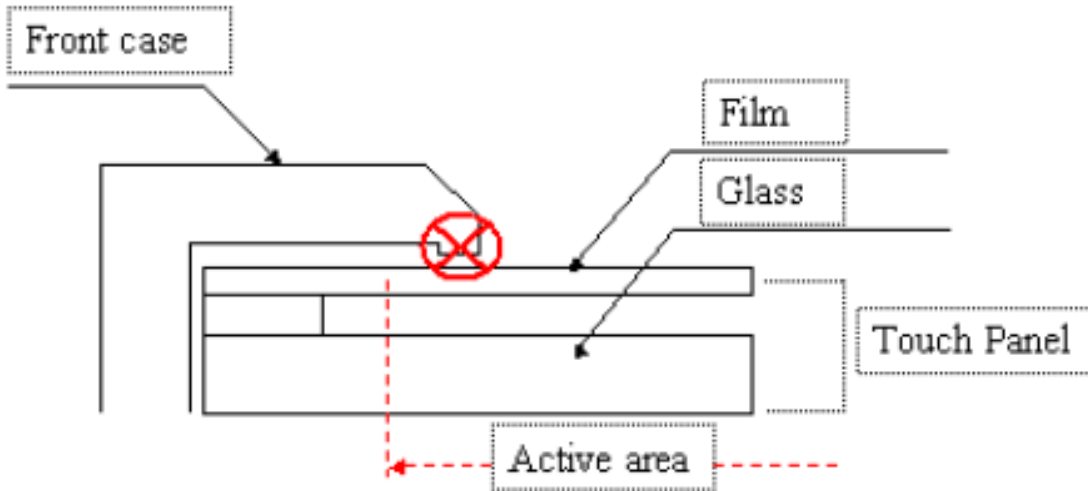

Use a buffer material (Gasket) between the touch-panel and front-case to protect damage and wrong operating.

Avoid the design that buffer material overlap and press on the inside of touch-panel viewing area.

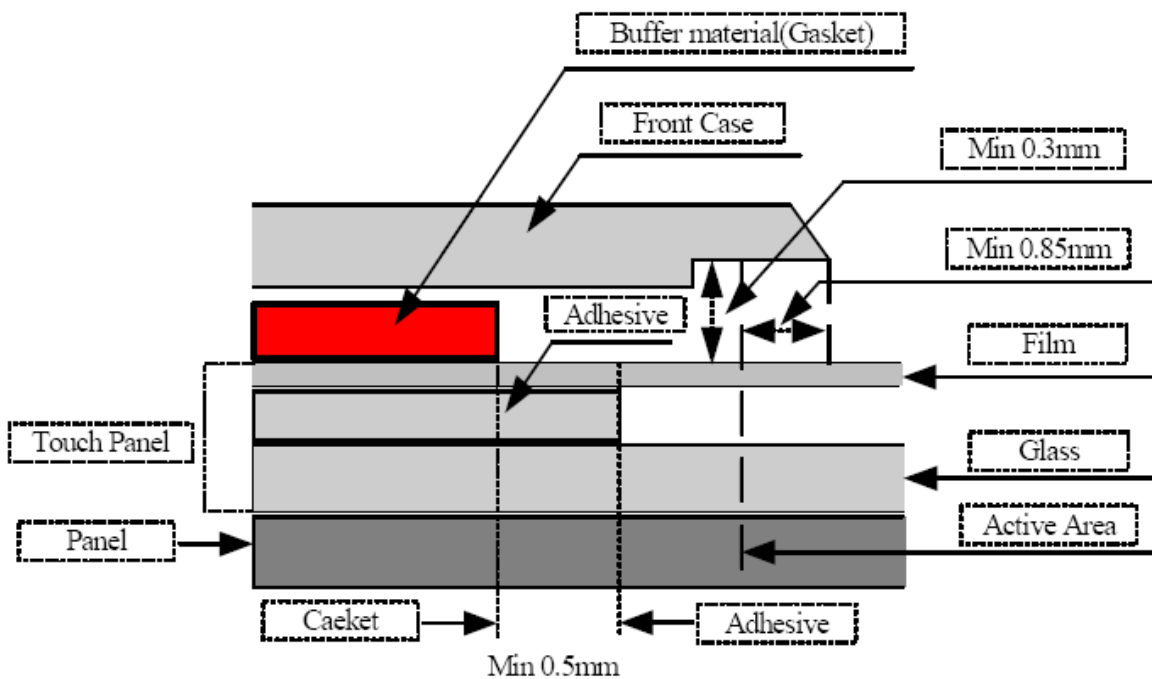

11.7 Mechanical Design Notice For Resistive Touch Panel

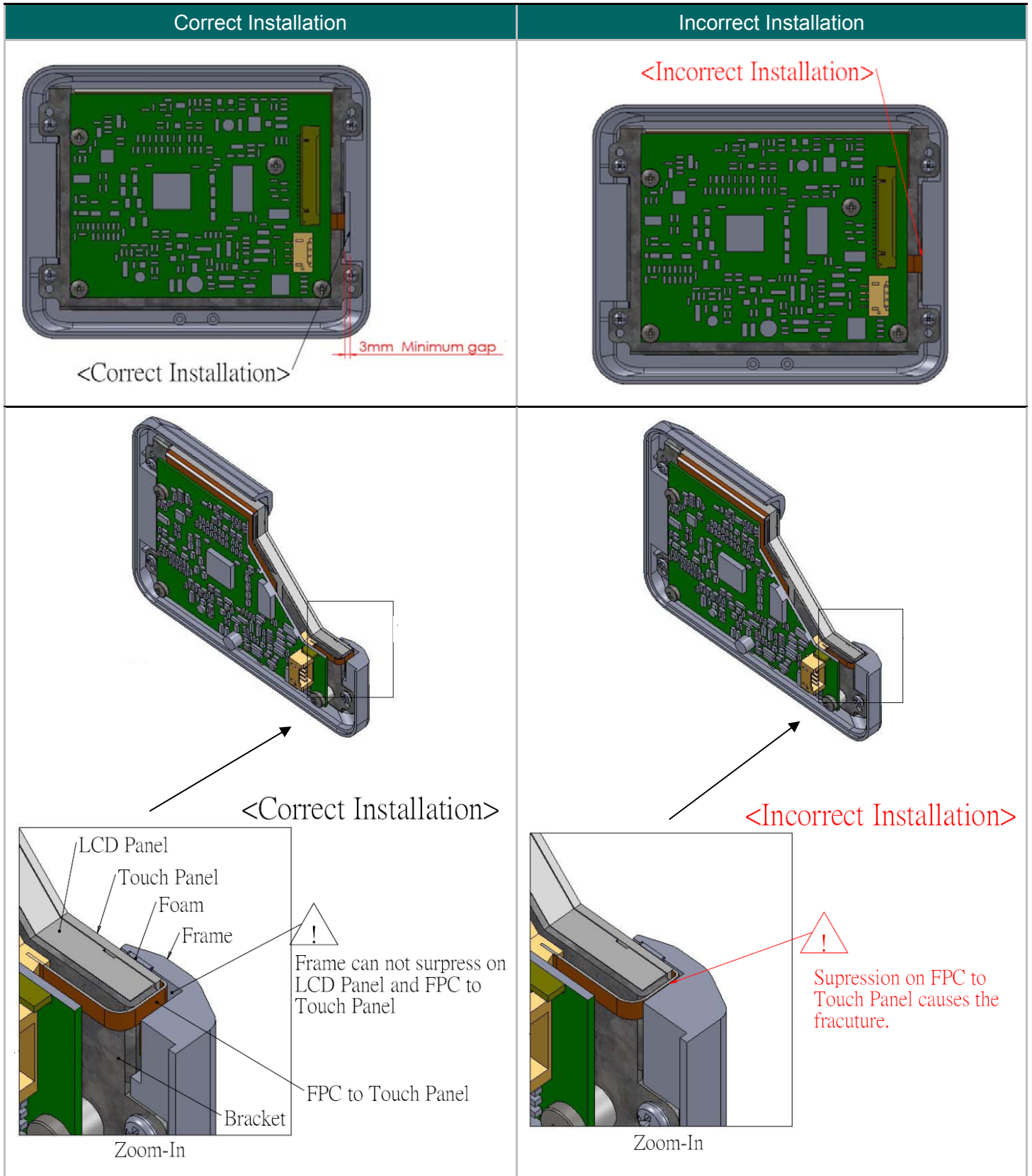

12. Key Function by OSD

12.1 Menu Operation

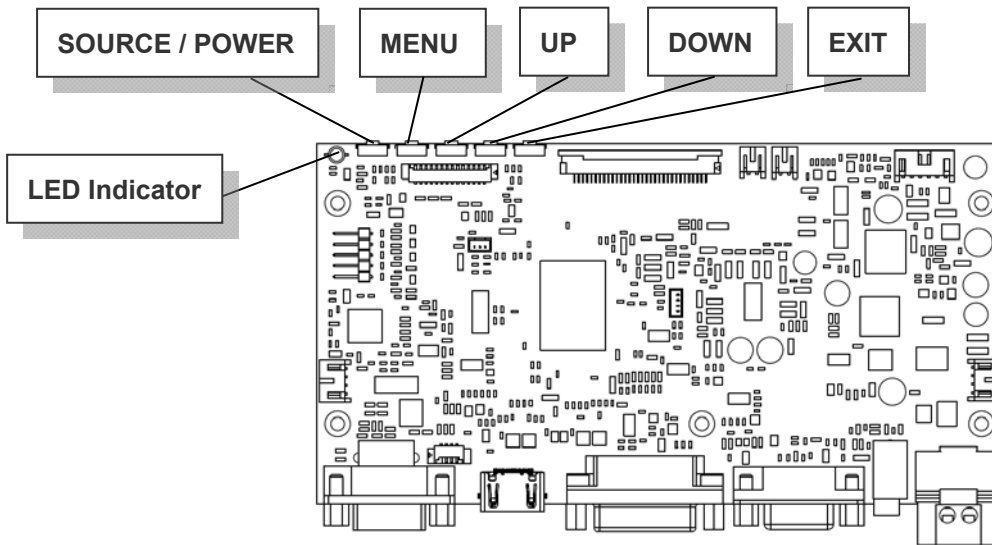

OSD ICON Instructions :

1. SOURCE / POWER : Input Source Switch / Power On/Off (※Press for 3 secs to turn off)
2. MENU / ENTER : (After turning on MENU, only ENTER is available.)
3. UP : Move Upward / Increase Value / Option Switch
4. DOWN : Move Downward / Decrease Value / Option Switch
5. EXIT : Return to Previous Page
6. LED Indicator
 - Waiting : Flickering Green
 - Power ON : Green
 - Power OFF : Red

Save OSD Setting:



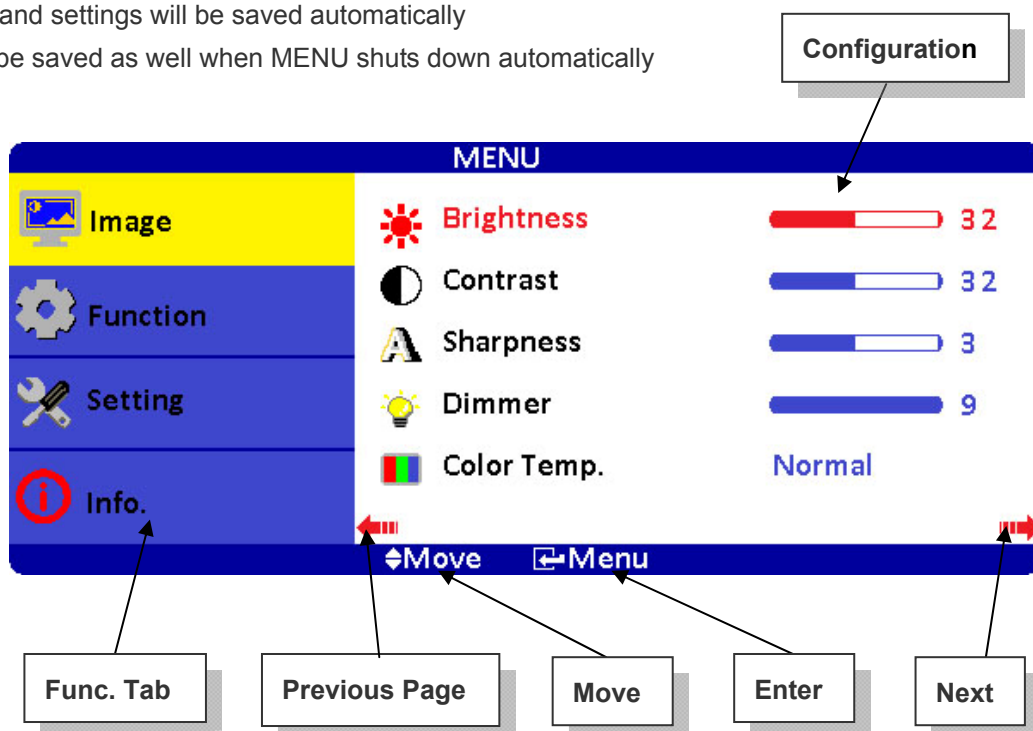







1. EXIT MENU and settings will be saved automatically
2. Settings will be saved as well when MENU shuts down automatically



Overview of the Menu :









Image

Indicator	Meaning	Default	Adjustable range	Remark
	Brightness	32	0~63	Adjust-Bar
	Contrast	32	0~63	Adjust-Bar
	Sharpness		1~5	Adjust-Bar
	Dimmer		0~15	Adjust-Bar
	Color Temp.	Normal	Normal / Warm / Cool	
	H-Position	0	-25~+25	VGA only
	V-Position	0	-25~+25	VGA only
	Clock	0	-25~+25	VGA only
	Phase	32	0~63	VGA only
	Auto	By different resolution		VGA only
	Exit			



Function

ICON	Meaning	Default	Adjustable range	Function	Remark
	Show Status	On	On / Off	Information of input source	ON: Show ; OFF: Hidden
	Blue Screen	On	On / Off	No signal input shows blue or black screen.	ON: Blue ; OFF: Black
	Auto Power On	On	On / Off	Modules turns on automatically without power key input.	ON: Auto ; OFF: Manual
	Detect Source	On	On / Off	Auto detect input source.	ON: Auto ; OFF: Normal
	Auto Power Saving	Off	6s / 15s / 30s / Off	Modules go ready when no input source is detected.	ON: Auto ; OFF: Normal
	Auto Sleep	Off	15M / 30M / 60M / Off	Modules go sleep when set timing is out.	ON: Auto ; OFF: Normal
	Exit				

Note : After configuration is set, RESET won't restore to default setting.



Setting

Indicator	Meaning	Default	Adjustable range	Remark
	Source	VGA	VGA / DVI / HDMI	
	Volume	32	0~63	
	Mute	Off	On / Off	On : Mute · Off : Sound
	Language	English	English / 中文 / 日本語 / 한국의 / Française / Deutsch / Italiano / Española / Português	
	Reset			Restore to default
	Exit			



Info.

MENU

Image

Source : VGA

Function

Resolution : 1024x768

Setting

H-Position : 48.2KHz

V-Position : 59.8Hz

Information

Program Ver : 1.00

Command Ver : 1.00

◀ Move ▶ Exit / Menu



HOT KEY When OSD Menu is Off :

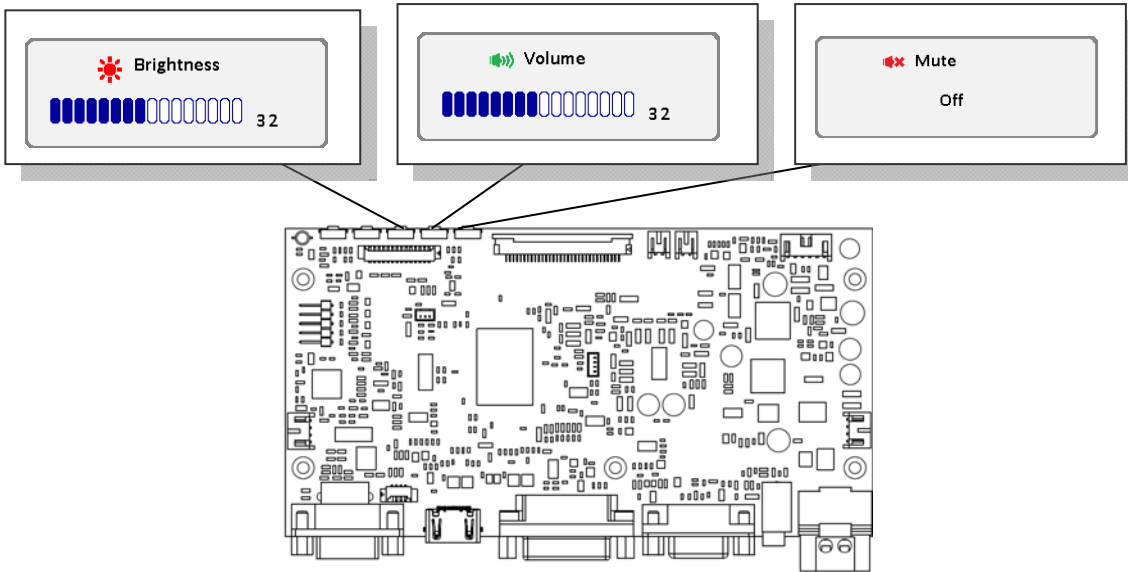

Information of Input Source and Functionality :

The screenshot shows the OSD menu with the following information:

- Input Source:** Points to 'VGA'.
- Resolution:** Points to '1024x768'.
- Detect Source Remaining Secs:** Points to a timer showing '5' seconds.
- VGA Mode Remaining Secs:** Points to a timer showing '1' second.

 A legend at the bottom left defines the [Source] as the Input Signal Switch.

Overview of Input Signals :

Indicator	Interface
	VGA
	DVI
	HDMI

13. Dimension Information

13.1 Unit (FCOP1700-TR)

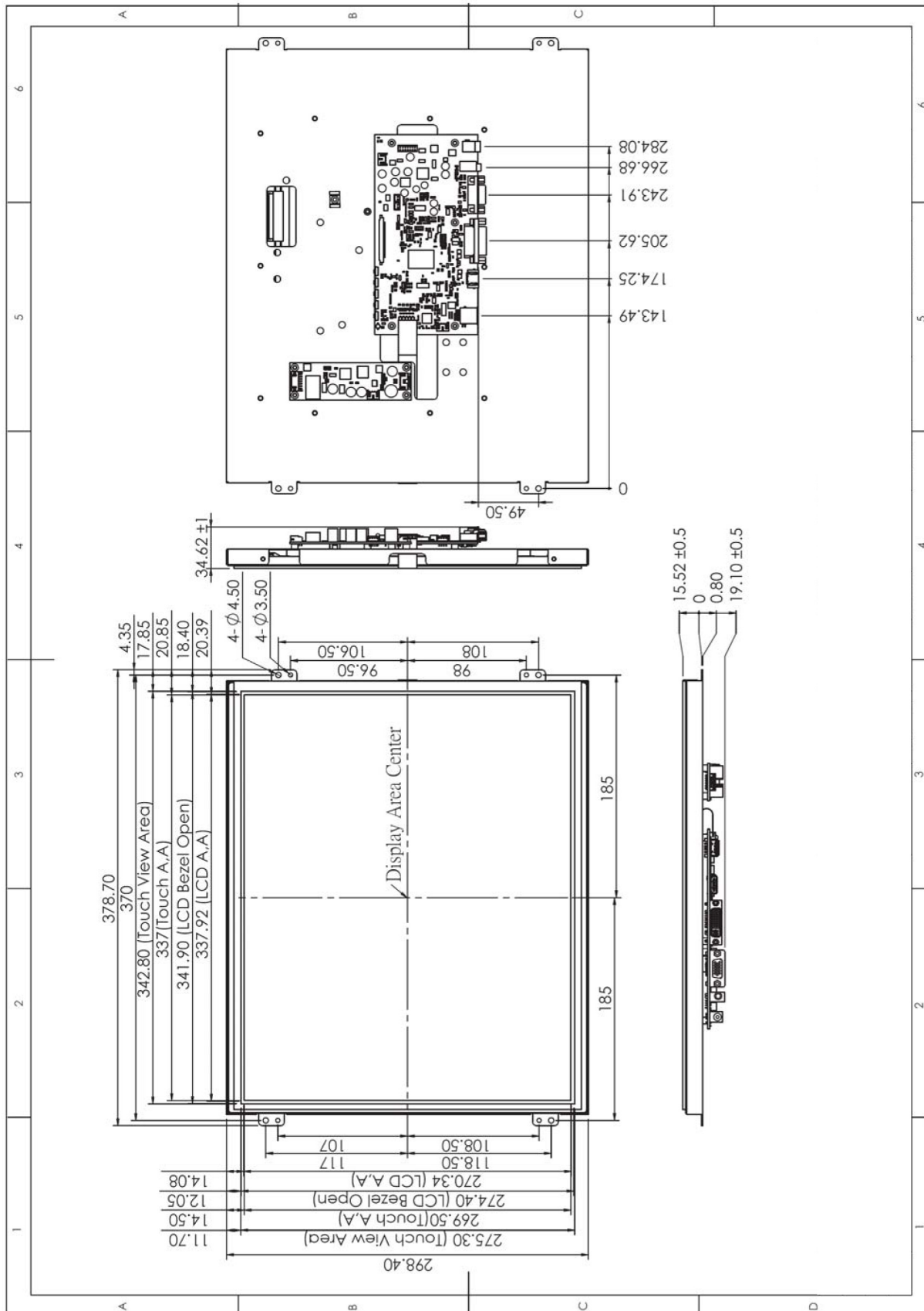



14. Appendix

14.1 TFT-LCD Mechanical Specifications

Parameter	Specifications	Unit
Screen Size	17 (diagonal)	Inch
Display Format	1280 x (R.G.B) x 1024	Dot
Active Area	337.92(H) x 270.336(V)	mm
Pixel Pitch	0.264(H) x 0.264(V)	mm
Pixel Arrangement	RGB vertical stripe	
Surface Treatment	Anti-Glare, Haze=25%, Hard Coating (3H)	
Bezel Opening Area	341.9(H) x 274.4(V)	

14.2 TFT-LCD Optical Characteristics

Parameter	Symbol	Condition	Min	Typ	Max	Unit	Remark
Viewing Angle	Horizontal	Left	75	85	---	deg	
		Right	75	85	---	deg	
	Vertical	Top	70	80	---	deg	
		Bottom	70	80	---	deg	
Contrast Ratio	CR	At optimized Viewing angle	---	1000	---	---	
Luminance without TP	L		200	250	---	cd/m ²	
LED Life Time		25°C	50000	---	---	Hrs	Note

Note: The "LED Life Time" is defined as the module brightness decrease to 50% original.

