

## SPECIFICATION APPROVAL SHEET

7" (1024x600) Digital TFT LCD 200nits, Aspect Ratio: 16:9, Input Signal HDMI 1.3a  
Maximum Support Resolution 1920x1080, Headphone Driver, 46mW@32Ω, No  
Touch, 5 Key Buttons Control, UART / RS232 Serial Remote Control  
(Option), 9 Language OSD Menu, LED Backlight, Single Operation Voltage +5V,  
Operating Temp -10 to 40C, No cables, no accessories, no Power adapter.

**MODEL: FCOPW0700**



i-Tech Company LLC

TOLL FREE: (888) 483-2418 • EMAIL: [info@itechlcd.com](mailto:info@itechlcd.com) • WEB: [www.iTechLCD.com](http://www.iTechLCD.com)



## *1. General Description*

### **1.1 Features**

- 7" (1024x600) Digital TFT LCD
- Aspect Ratio: 16:9
- Input Signal HDMI 1.3a
- Maximum Support Resolution 1920x1080
- Headphone Driver, 46mW@32Ω
- Touch Screen 4W Resistive
- 5 Key Buttons Control
- UART / RS232 Serial Remote Control (Option)
- 9 Language OSD Menu
- LED Backlight
- Single Operation Voltage +5V

### **1.2 Applications**

- Industrial
- Medical Environment
- Instrument Display
- Kiosk
- Security
- Signage
- Office Electronics
- Home Application
- Educate Application



## 2. Contents

Contents	Page
<b>1. General Description.....</b>	<b>1</b>
1.1 Features	1
1.2 Applications	1
<b>2. Contents.....</b>	<b>2-3</b>
<b>3. Specifications.....</b>	<b>4</b>
<b>4. Block Diagram.....</b>	<b>4</b>
<b>5. Order Information.....</b>	<b>5</b>
5.1 Unit	5
<b>6. Accessories (Option).....</b>	<b>6</b>
<b>7. Operation manual / Connection.....</b>	<b>7</b>
7.1 Driver Board Manual	7
7.2 RS232 Touch Driver Board	7
<b>8. Pin Description.....</b>	<b>8-10</b>
8.1 J101 : Pin Assignment of Power Input (DC-Jack Inside Diameter:2.5 $\phi$ Outside Diameter:5.5 $\phi$ Side Entry Type)	8
8.2 J702: Pin Assignment of UART (Pitch 1.25mm 4Pin, Top Entry Type)	8
8.3 J401 : Pin Assignment of HDMI-A Type Input (HDMI 1.3a -19Pin Female)	8
8.4 J601D : Pin Assignment of Key Board (Pitch 1.25mm 12Pin , Side Entry Type)	9
8.5 J701 : Pin Assignment of Touch USB (USB A Type - Female 2.0mm, Side Entry Type )(Option)	9
8.6 J1B : Pin Assignment of Touch RS232	9
8.6 J301 : Pin Assignment of Phone Jack (Outside Diameter:3.5 $\phi$ Side Entry Type)	10
<b>9. Absolute Maximum Ratings.....</b>	<b>10</b>
9.1 Absolute Maximum Ratings	10
<b>10. Recommended Operating Conditions.....</b>	<b>10</b>
10.1 Electrical Characteristics	10
10.2 Support Display Mode Characteristics	10
<b>11. 4W Resistive Touch Panel Characteristics.....</b>	<b>11-14</b>
11.1 4W Electrical Performance	11
11.2 4W Optical Performance	11
11.3 4W Mechanical Performance	11
11.4 4W Durability Performance	11
11.5 Resistive Touch Panel Operation System Support	12
11.6 Resistive Touch Panel Integration Design Guide	13
11.7 Mechanical Design Notice For Resistive Touch Panel	14
<b>12. Key Function by OSD.....</b>	<b>15-18</b>
12.1 Menu Operation	15-18
<b>13. Dimension Information.....</b>	<b>19-21</b>



13.1 Unit (FCOPW0700)	19
<b>14. Appendix.....</b>	<b>20</b>
14.1 TFT-LCD Mechanical Specifications	20
14.2 TFT-LCD Optical Characteristics	20
<b>15. Revision History.....</b>	<b>21</b>
15.1 Record of Revision	21

### 3. Specifications

LCD	
Panel Size	7"
Resolution (Pixels)	1024x600
Color	262K
Luminance without RTP	250 cd/m <sup>2</sup>
Luminance (RTP)	200 cd/m <sup>2</sup>
Contrast Ratio	700
Viewing Angle	75 / 75 / 70 / 75
LED Life Time	15K (Min)
Power Requirement	
Power Input (DC Jack 2.5 φ)	+5VDC
Power Consumption	3.6 Watts
Touch Screen	
Resistive Type	USB / RS232(Optional) Interface
Resistive Type Support OS	Windows / Linux / DOS / Mac / QNX

Input Signal		
HDMI	1.3a	
Audio		
Headphone Driver	46mW@32Ω Phone Jack φ 3.5	
Controls		
Key	5 Buttons	
Serial Remote Control	UART / RS232 (Option)	
Environment		
	Without RTP	4W RTP
Temperature Range	Operating	-10~+40 (Ts) °C
	Storage	-20~+60°C
High Temperature & High Humidity (Non-condensing)	Operating	40°C / 90%

### 4. Block Diagram

FCOPW0700

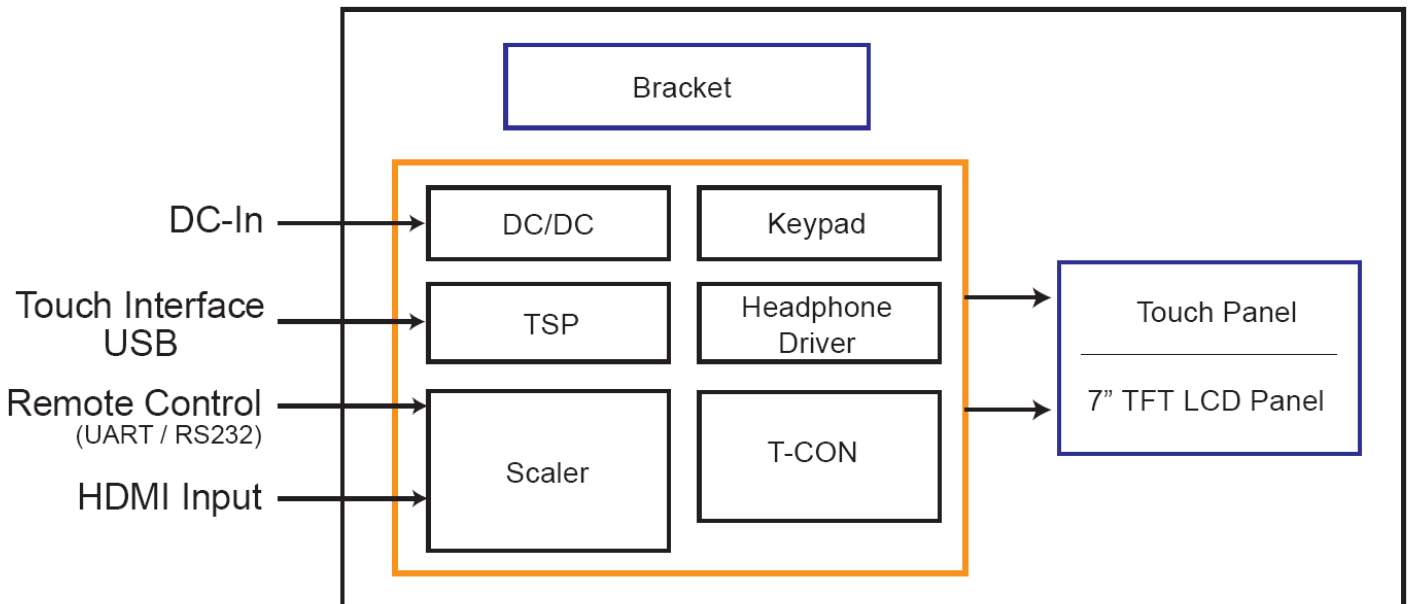



## 5. Order Information

### 5.1 Unit

Parameter	FCOPW0700			Unit	Remark
HDMI	⊙				
Touch Panel Type	-				
Touch Screen Interface	-				
Headphone Driver	⊙				
5 Keys	⊙				
UART Remote Control	⊙				
Dimension	180.5 x 107.2 x 22.2			mm	
Weight	314.5			g	±10%
Condition	Standard				

**Note: 1.** The assembling of panel and bracket is aimed for delivery, packaging and experiment. If the demand of shockproof and long-term fix, pls have it into consideration of mechanism design.

Optional Functions	
<b>Parameter</b>	<ul style="list-style-type: none"> <li>- RS232 Remote Control</li> <li>- External Key</li> <li>- Accessories (Refer to Page 6)</li> </ul>

## 6. Accessories (Option)

Before you begin installing the KIT, please make sure that the following materials have been shipped:



A.



B.



C.



D.



E.



E.



D.

- A. AC to DC Adapter (L:1500mm,100-240V<sub>AC</sub> 50-60Hz to +5V<sub>DC</sub> @ 3A,  $\phi$  2.5)
- B. Power Cord (L:1800mm, Plug Type B for USA)
- C. HDMI Cable (L:1800mm)
- D. USB Cable (L:1800mm)
- E. RS-232 Transmits Line (TSP Cable 5P 2.0mm-RS232 Cable L:1800mm)
- F. AUDIO Cable (L:1800mm)
- G. Touch Screen Driver CD Disk / User Manual

## 7. Operation manual / Connection

### 7.1 Driver Board Manual

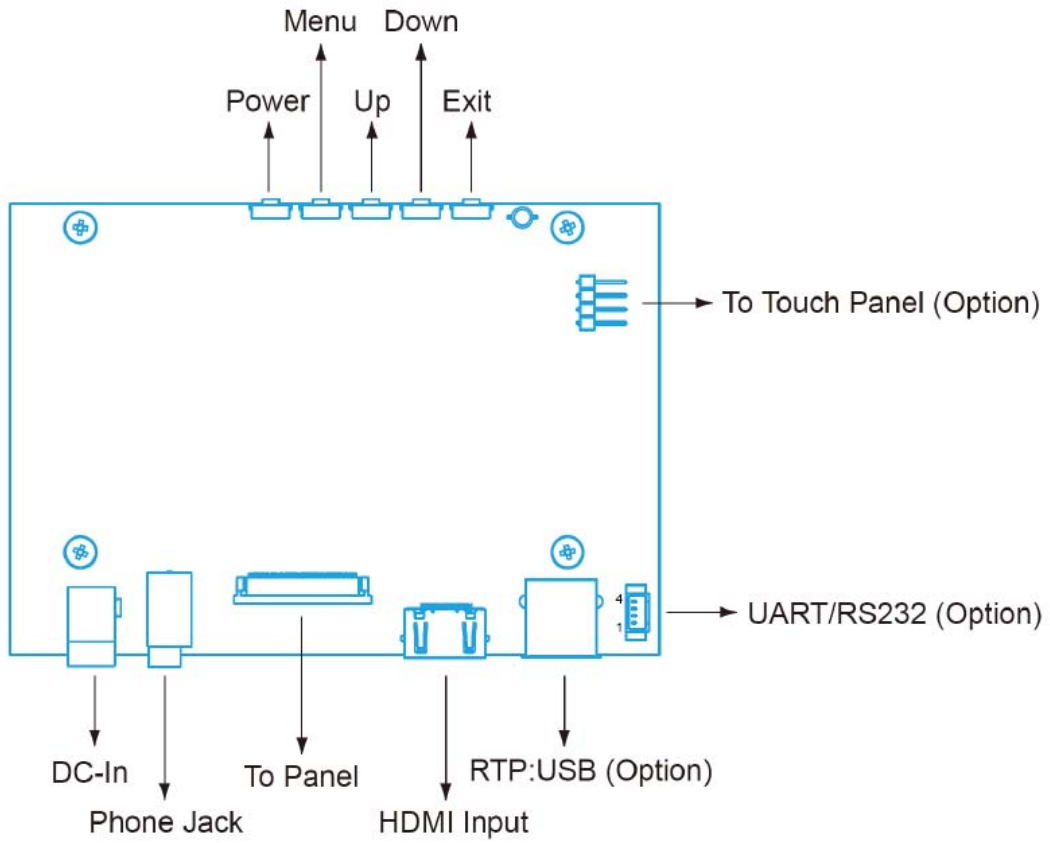

### 7.2 RS232 Touch Driver Board

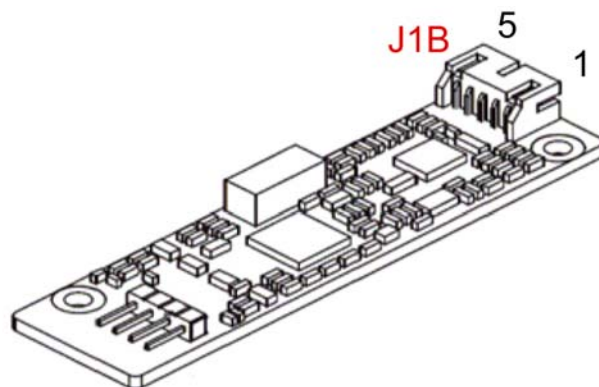



## 8. Pin Description

### 8.1 J101 : Pin Assignment of Power Input (DC Jack Inside Diameter:2.5 ϕ Outside Diameter:5.5 ϕ Side Entry Type)

Pin No.	Symbol	I/O	Description	Remark
1	DC-In	I	+5 Vdc Input Voltage	
2	GND	-	Power Ground	

### 8.2 J702 : Pin Assignment of UART (Pitch 1.25mm 4Pin, Top Entry Type)

※ Connector Part No.: MS24014 (STM) [Same as 53398-0471 (MOLEX)] ;

※ Matching Connector Part No.: P24014 (STM) [Same as 51021-0400 (MOLEX)].

Pin No.	Symbol	I/O	Description	Remark
1	TX / RS232 TX (Option)	O	UART / RS232 (Option) Transmission Data	
2	RX / RS232 RX (Option)	I	UART / RS232 (Option) Receive Data	
3	GND	-	Ground	
4	+3.3Vdc	O	+3.3Vdc Output Voltage	

**Note: All Functions can be controlled by UART , About UART command list please contact FDT sales.**

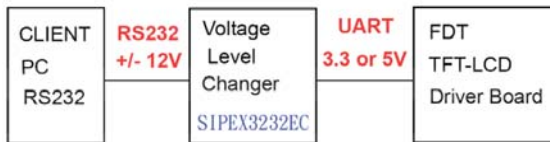

### 8.3 J401 : Pin Assignment of HDMI-A Type Input (HDMI 1.3a -19Pin Female)

Pin No.	Symbol	I/O	Description	Remark
1	DATA2+	I	Positive HDMI Input for B Link Data Channel 2	
2	DET_HDMI	-	HDMI Detect	
3	DATA2-	I	Negative HDMI Input for B Link Data Channel 2	
4	DATA1+	I	Positive HDMI Input for B Link Data Channel 1	
5	GND	-	Ground	
6	DATA1-	I	Negative HDMI Input for B Link Data Channel 1	
7	DATA0+	I	Positive HDMI Input for B Link Data Channel 0	
8	GND	-	Ground	
9	DATA0-	I	Negative HDMI Input for B Link Data Channel 0	
10	DCLK+	I	Positive HDMI Input for B Link Clock Channel	
11	GND	-	Ground	
12	DCLK-	I	Negative HDMI Input for B Link Clock Channel	
13	NC	-	No Connection	
14	NC	-	No Connection	
15	HDMI_SCL	I	DDC2 Clock	
16	HDMI_SDA	I	DDC2 Data	
17	GND	I	DDC/CEC Ground	
18	HDMI5V	I	HDMI +5Vdc Input	
19	HDMI_HPD	I	Hot Plug Detect	

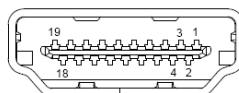

**8.4 J601D : Pin Assignment of Key Board (Pitch 1.25mm 12Pin , Side Entry Type)(Option)**

※ Connector Part No.: MS240112R (STM) [Same as 53261-1219 (MOLEX)] ;

※ Matching Connector Part No.: P240112 (STM) [Same as 51021-1200 (MOLEX)].

Pin No.	Symbol	I/O	Description	Remark
1	-	-	Don't Connect	
2	SW5	I	EXIT	
3	SW4	I	DOWN	
4	SW3	I	UP	
5	SW2	I	MENU / S	
6	SW1	I	POWER / SOURCE	
7	GND	-	Ground	
8	VDDP	-	VDDP +3.3Vdc Output Voltage	
9	-	-	Don't Connect	
10	RED	O	Indicator red LED for power off control	
11	GREEN	O	Indicator green LED for power on control	
12	GND	-	Ground	

**8.5 J701 : Pin Assignment of Touch USB (USB A Type - Female 2.0mm, Side Entry Type )(Option)**

Pin No.	Symbol	I/O	Description	Remark
1	VBUS	-	USB VCC	
2	D-	-	DATA (-)	
3	D+	-	DATA (+)	
4	DGND	-	Digital Ground	

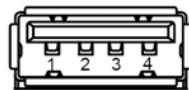

**8.6 J1B : Pin Assignment of Touch RS232 (Pitch 2.0mm 5Pin , Side Entry Type)(Option)**

※ Connector Part No.: M24265R (STM) [Same as S5B-PH-KL (JST)] ;

※ Matching Connector Part No.: P24265 (STM) [Same as PHR-5 (JST)].

Pin No.	Symbol	I/O	Description	Remark
1	GND	-	Ground	
2	V (+5V)	I	+5 Vdc Input Voltage	
3	GND	-	Ground	
4	TX	O	Transmission Data	
5	RX	I	Receive Data	

**8.7 J301 : Pin Assignment of Phone Jack (Outside Diameter:3.5 φ Side Entry Type)**

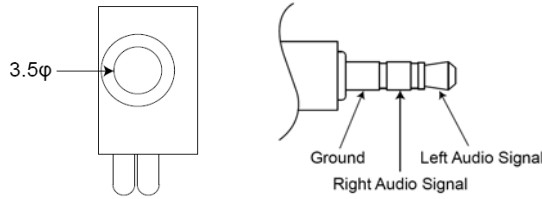

## 9. Absolute Maximum Ratings

**9.1 Absolute Maximum Ratings**

Parameter	Symbol	Min	Max	Unit	Remark
Input Voltage	V <sub>in</sub>	+4.5	+6	V	
Digital Input Signal	TTL	0.3	3.6	V	
HDMI Input Signal		-	165	MHz	
Operating Temp. without RTP		-10	+40 (Ts)	°C	
Storage Temp. without RTP		-20	+60	°C	
Operating Temp. 4W RTP		-10	+40 (Ts)	°C	
Storage Temp. 4W RTP		-20	+60	°C	
High Temperature & High Humidity (Non-condensing) without RTP		-	+40 / 90	°C / %	
High Temperature & High Humidity (Non-condensing) 4W RTP		-	+40 / 90	°C / %	

## 10. Recommended Operating Conditions

**10.1 Electrical Characteristics**

Parameter	Symbol	I/O	Min	Typ	Max	Unit	Note
Input Voltage	DC-in	I	+4.8	+5	+5.8	V	
Total Current	I-in	I		720		mA	+5V
Power Consumption		I		3.6		W	±15%
Output Voltage	VDD	O	3.2	3.3	3.4	V	
HDMI Input Signal					165	MHz	

**10.2 Support Display Mode Characteristics**

Dots per inch	H	Unit	Polarity	V	Unit	Polarity	Note
800*600	37.88	KHz	Positive	60.3	Hz	Positive	
1024*600	37.54	KHz	Positive	60	Hz	Positive	
1024*768	48.36	KHz	Positive	60	Hz	Positive	
1280 × 1024	63.98	KHz	Positive	60	Hz	Positive	
1600 × 1200	75	KHz	Positive	60	Hz	Positive	
1920 × 1080	67.5	KHz	Positive	60	Hz	Positive	



## 11. 4W Resistive Touch Panel Characteristics

### 11.1 4W Electrical Performance

Parameter	Symbol	Min	Typ	Max	Unit	Note
Terminal Resistance	X	20		500	$\Omega$	
	Y	20		500	$\Omega$	
Linearity				1.5	%	
Insulation Impedance		20			M $\Omega$	DC 25V
Response Time				10	ms	

### 11.2 4W Optical Performance

Parameter	Specifications
Light Transmittance	>80%
Haze	< 10%

### 11.3 4W Mechanical Performance

Parameter	Specifications
Input Method	Stylus or Finger
Operating Force	100g, R8 Silicon Rubber, 60HS
Surface Hardness	3H pencil, pressure 1N/45°

### 11.4 4W Durability Performance

Parameter	Specifications
Knock Test	1,000,000 times, Weight $\leq$ 100g. 2 times/sec (Tip R8 mm Silicone rubber)
Pen Sliding Test	100,000 times, Weight $\leq$ 100g. 30 times/sec (Tip R0.8 mm Stylus pen)



**11.5 Resistive Touch Panel Operation System Support**

Driver Vender : EETI (eGalax\_eMPIA Technology Inc.)

OS	Version	Interface
<b>Windows</b>	Windows XP Embedded	USB
	Windows Vista, XP, 2000	
	Windows Embedded POSReady 2009	
	Windows Embedded 7, 8	
	Windows 7, 8, 8.1, 10	
<b>Windows CE</b>	Windows CE.Net (4.x / 5.0)	USB
	Windows CE 6.0	
	Windows Embedded Compact 7	
	Windows Embedded Compact 2013	
<b>Linux</b>	Kernel 2.4.x (x86)	USB
	Kernel 2.6.23 Downward (X86)	
	Kernel 2.6.24 Upward and 3.x.x (X86 / ARM / MIPS)	
<b>Android</b>	Android Version 2.3.x upwards (X86 / ARM / MIPS)	USB
<b>Mac OS</b>	Mac OS X 10.5.3 Leopard ( Power PC )	USB
	Mac OS X 10.7.4 Earlier ( 32Bit ) ( Intel CPU )	
	Mac OS X 10.7.4 Earlier ( 64Bit ) ( Intel CPU )	
	Mac OS X 10.7.5 ( 32Bit ) ( Intel CPU )	
	Mac OS X 10.7.5 ( 64bit ) ( Intel CPU )	
	Mac OS X 10.8.x Mountain Lion ( Intel CPU )	
	Mac OS X 10.9.x Mavericks ( Intel CPU )	
	Mac OS X 10.10.x Yosemite ( Intel CPU )	
<b>QNX</b>	QNX RTOS V6.3	USB
	QNX Neutrino RTOS V6.5/6.4	
<b>DOS</b>	DOS	PS2

Please refer to the iTech website for the latest driver version and support operating system.

iTech website: <http://www.itechlcd.com>

**11.6 Resistive Touch Panel Integration Design Guide**

Avoid the design that Front-case overlap and press on the active area of the touch-panel.

Give enough gap (over 0.5mm at compressed) between the front case and touch-panel to protect wrong operating.

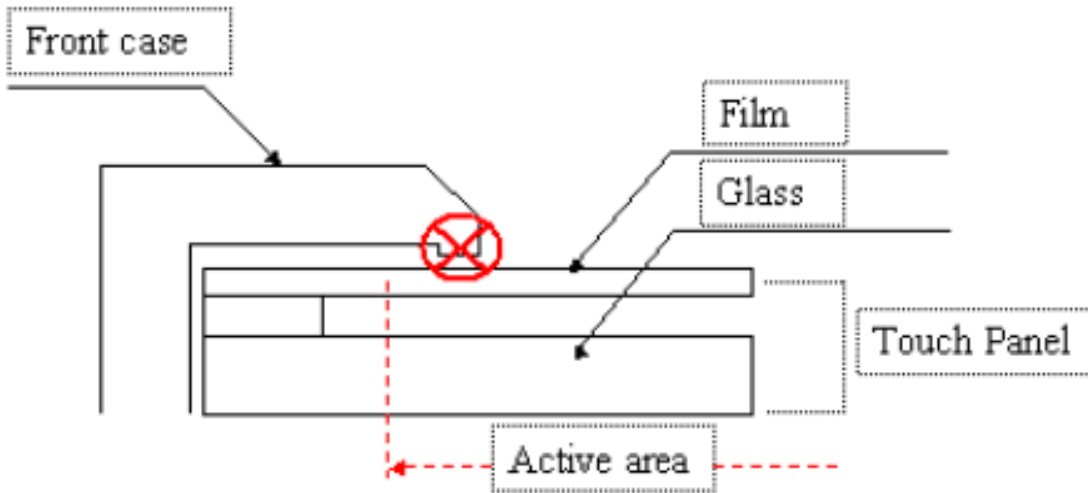

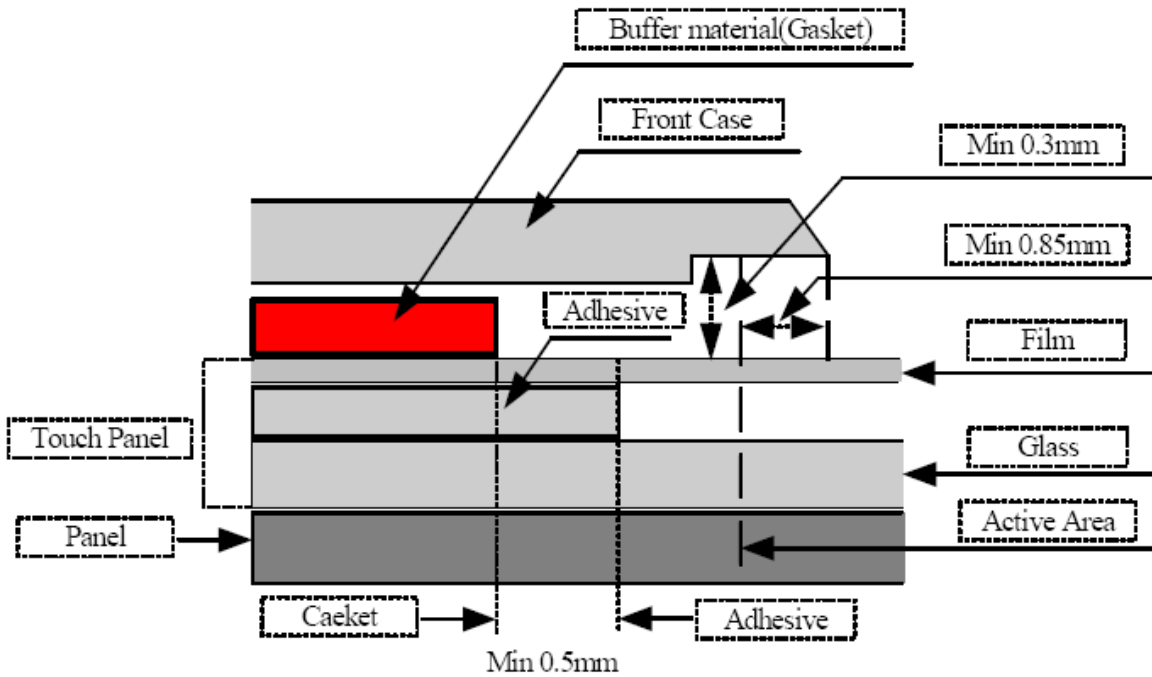

Use a buffer material (Gasket) between the touch-panel and front-case to protect damage and wrong operating.

Avoid the design that buffer material overlap and press on the inside of touch-panel viewing area.

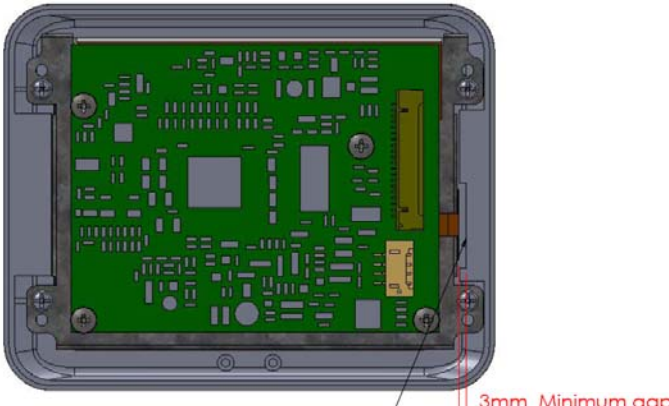
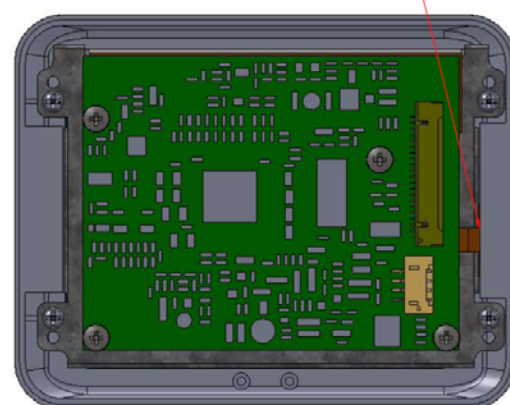
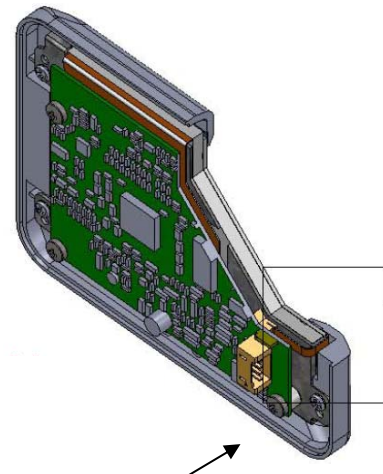
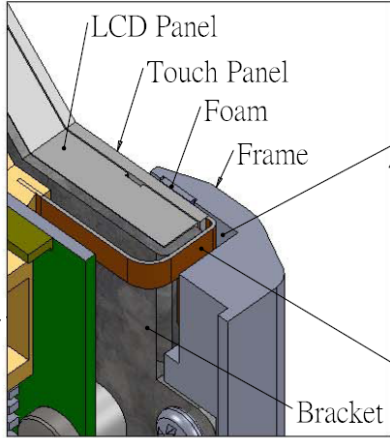

**11.7 Mechanical Design Notice For Resistive Touch Panel**

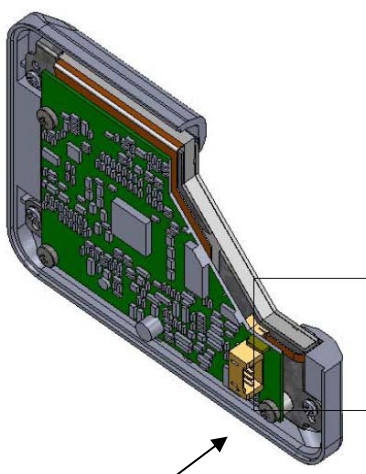
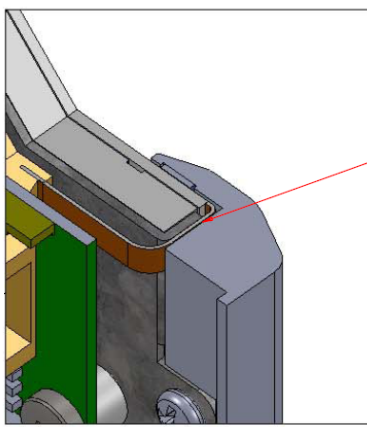
Correct Installation	Incorrect Installation
 <p data-bbox="159 795 478 840">&lt;Correct Installation&gt;</p> <p data-bbox="558 761 766 795">3mm Minimum gap</p>	 <p data-bbox="957 369 1308 414">&lt;Incorrect Installation&gt;</p>
 <p data-bbox="399 1400 766 1444">&lt;Correct Installation&gt;</p> <div data-bbox="87 1456 478 1892">  <p data-bbox="159 1467 399 1881">LCD Panel Touch Panel Foam Frame Bracket</p> </div> <p data-bbox="223 1892 319 1926">Zoom-In</p> <div data-bbox="478 1568 782 1859">  <p data-bbox="478 1635 782 1724">Frame can not surpress on LCD Panel and FPC to Touch Panel</p> <p data-bbox="478 1814 734 1859">FPC to Touch Panel</p> </div>	 <p data-bbox="1117 1411 1500 1456">&lt;Incorrect Installation&gt;</p> <div data-bbox="813 1456 1181 1881">  <p data-bbox="1197 1568 1260 1635">!</p> <p data-bbox="1197 1646 1500 1747">Supression on FPC to Touch Panel causes the fracture.</p> </div> <p data-bbox="957 1881 1053 1915">Zoom-In</p>

## 12. Key Function by OSD

### 12.1 Menu Operation

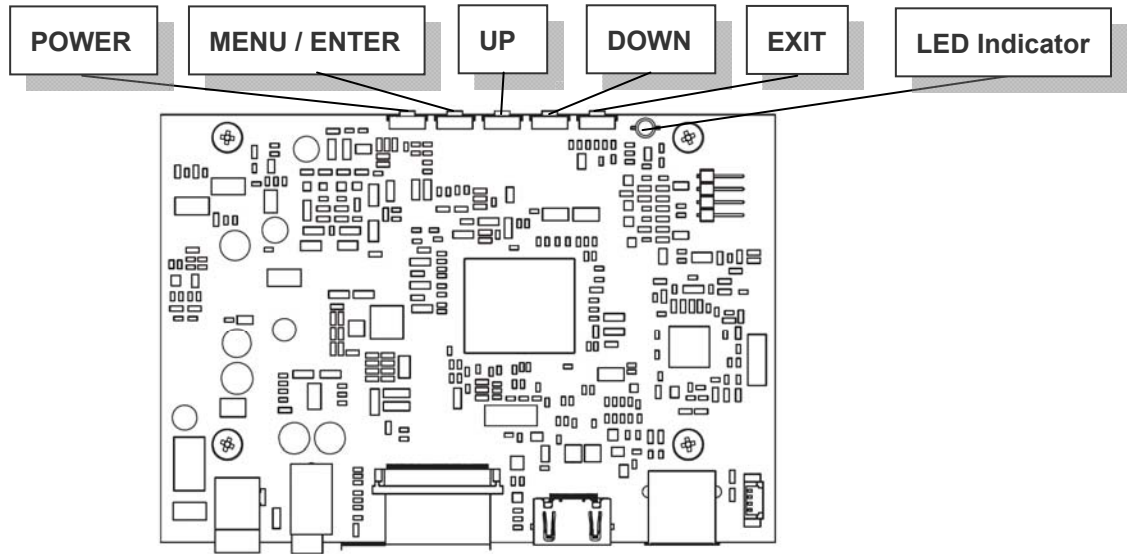

### OSD ICON Instructions :

1. POWER : Power On/Off
2. MENU / ENTER : (After turning on MENU, only ENTER is available)
3. UP : Move Upward / Increase Value / Option Switch
4. DOWN : Move Downward / Decrease Value / Option Switch
5. EXIT : Return to Previous Page
6. LED Indicator
  - Waiting : Flickering Green
  - Power ON : Green
  - Power OFF : Red

### Save OSD Setting:

1. EXIT MENU and settings will be saved automatically
2. Settings will be saved as well when MENU shuts down automatically

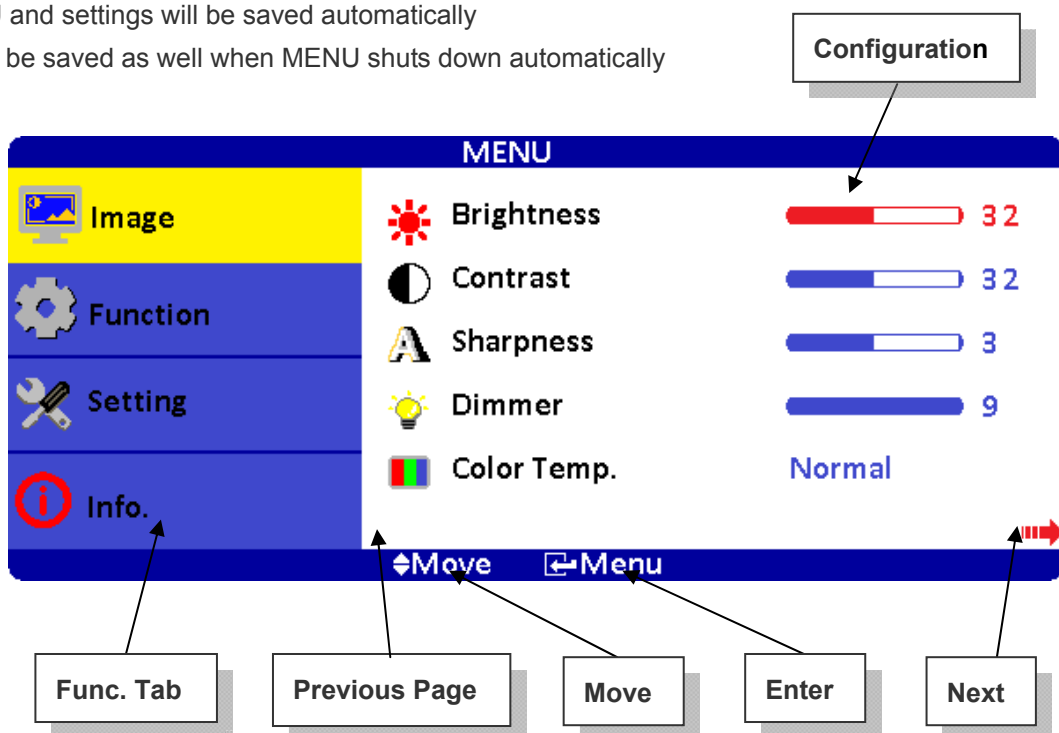



## Overview of the Menu :



### Image

Indicator	Meaning	Default	Adjustable range	Remark
	Brightness	32	0~63	Adjust-Bar
	Contrast	32	0~63	Adjust-Bar
	Sharpness	3	1~5	Adjust-Bar
	Dimmer	15	0~15	Adjust-Bar
	Color Temp.	Normal	Normal / Warm / Cool	
	Exit			



### Function

ICON	Meaning	Default	Adjustable range	Function	Remark
	Show Status	On	On / Off	Information of input source	ON: Show ; OFF: Hidden
	Blue Screen	On	On / Off	No signal input shows blue or black screen.	ON: Blue ; OFF: Black
	Auto Power On	On	On / Off	Modules turns on automatically Without power key input.	ON: Auto ; OFF: Manual
	Auto Power Saving	Off	6s / 15s / 30s / Off	Modules go ready when no input source is detected.	ON: Auto ; OFF: Normal
	Auto Sleep	Off	15M / 30M / 60M / Off	Modules go sleep when set timing is out.	ON: Auto ; OFF: Normal
	Exit				

**Note :** After configuration is set, **RESET** won't restore to default setting.



### Setting

Indicator	Meaning	Default	Adjustable range	Remark
	Volume	32	0~63	
	Mute	Off	On / Off	On : Mute · Off : Sound
	Mirror	Off	On / Off	Left-right reversal
	Flip	Off	On / Off	Upside down
	Language	English	English / 中文 / 日本語 / 한국의 / Française / Deutsch / Italiano / Española / Português	Reset won't restore to default setting
	Reset			Restore to default
	Exit			



Info.

## MENU

Image

Source : HDMI

Function

Resolution : 1024x600

Setting

H-Position : 37.5KHz  
V-Position : 59.8Hz

Information

Program Ver : 1.00  
Command Ver : 1.00

↔ Move   ← Exit / Menu



### Hot Key When OSD Menu is Off :

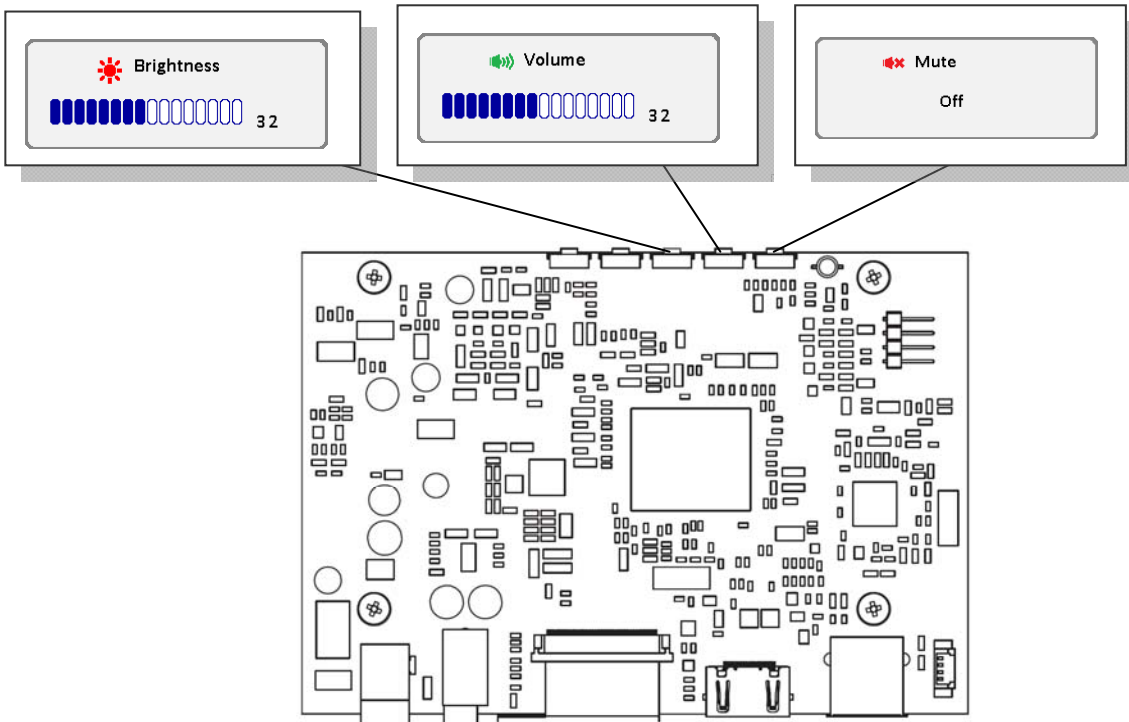

## Information of Input Source and Functionality :

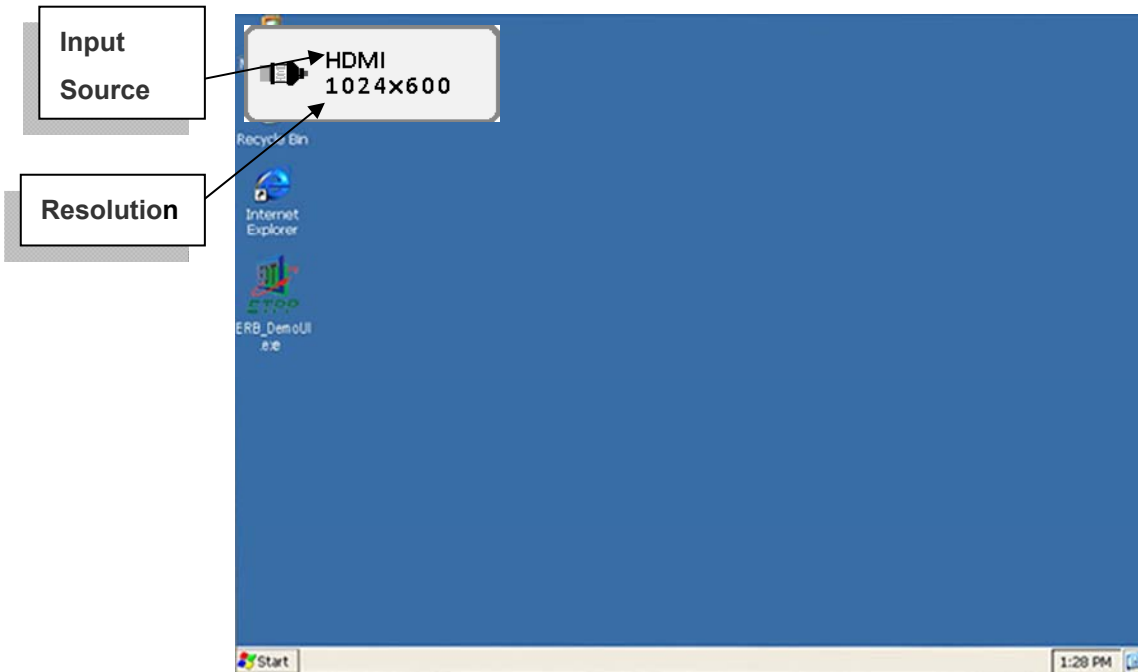

[Source] : Input Signal Switch

## Overview of Input Signals :

Indicator	Interface
	HDMI

## 13. Dimension Information

### 13.1 Unit (FCOPW0700)

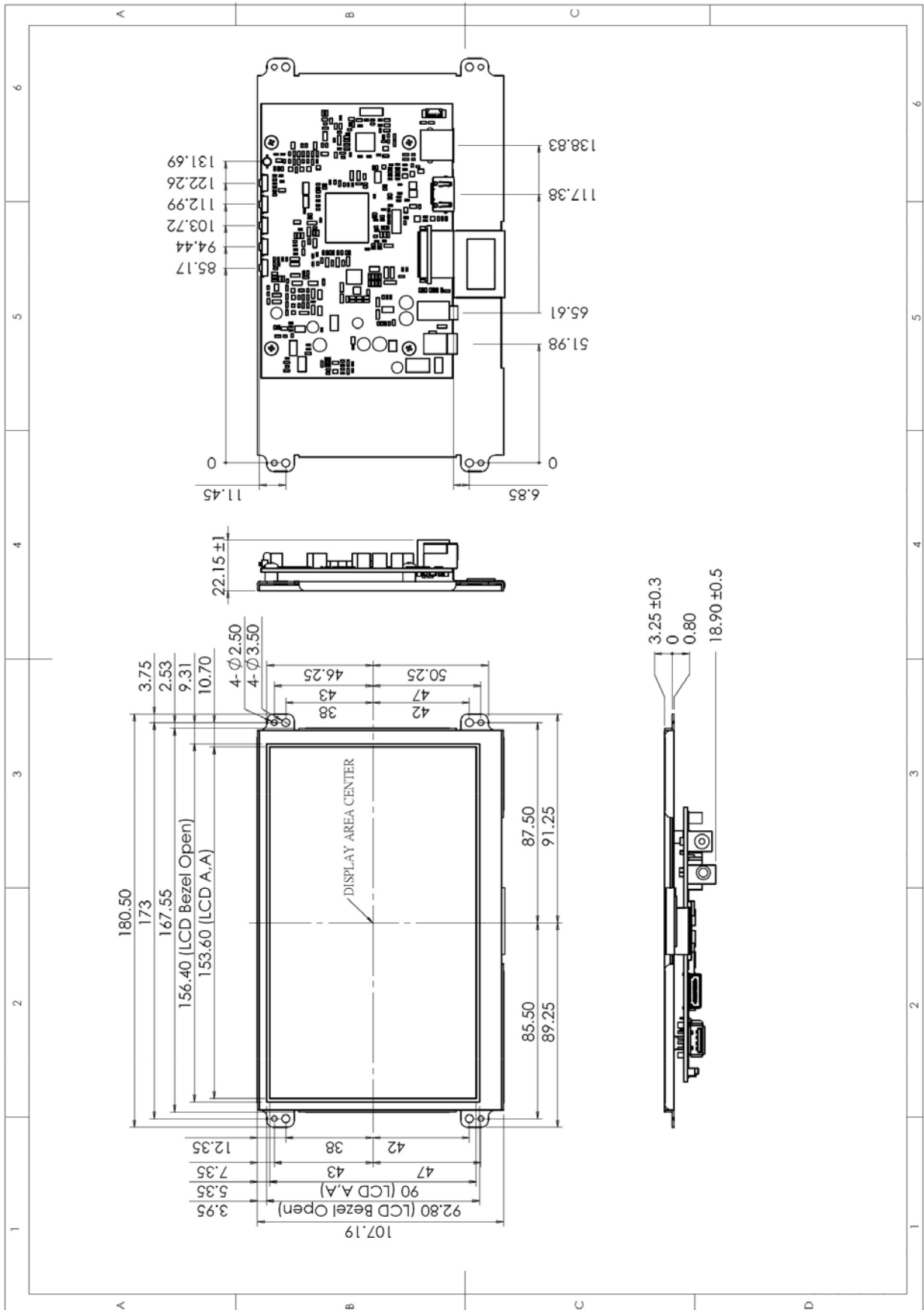



## 14. Appendix

### 14.1 TFT-LCD Mechanical Specifications

Parameter	Specifications	Unit
Screen Size	7 (diagonal)	Inch
Display Format	1024 x (R.G.B) x 600	Dot
Active Area	153.6(W) × 90.0(H)	mm
Pixel Pitch	0.15(H) x 0.15(V)	mm
Pixel Arrangement	RGB-stripe	
Surface Treatment	Clear	

### 14.2 TFT-LCD Optical Characteristics

Parameter	Symbol	Condition	Min	Typ	Max	Unit	Remark
Viewing Angle	Horizontal	Left	65	75	---	deg	
		Right	65	75	---	deg	
	Vertical	Top	60	70	---	deg	
		Bottom	65	75	---	deg	
Contrast Ratio	CR	At optimized Viewing angle	500	700	---	---	
Luminance without RTP	L		200	250	---	cd/m <sup>2</sup>	
LED Life Time		25°C	15000	---	---	Hrs	Note

Note: The "LED Life Time" is defined as the module brightness decrease to 50% original.



## 15. Revision History

### 15.1 Record of Revision

NO	Date	Description	Page	Note
1.0	October 6, 2014	· First draft	21	
1.1	September 11, 2015	· Modify 10.1 Electrical Characteristics	11	
		· Modify 14.1 Menu Operation	17	
1.2	October 13, 2015	· Modify 7. Dimension Information	8	
		· Modify 10.1 Electrical Characteristics	11	
1.3	October 6, 2016	· Modify Operating Temperature	4, 10	
		· Add High Temperature & High Humidity	4, 10	
		· Add Dimension · Weight · Condition	5	
		· Modify HDMI Cable length	6	
		· Modify 11.5 Resistive Touch Panel Operation System Support	12	
1.4	December 27, 2017	· Add RS232	-	
		· Modify 1.1 Features	1	
		· Add 11.5 Resistive Touch Panel Operation System Support Note	12	