

## SPECIFICATION APPROVAL SHEET

Open frame 10.1" (1280x800) Digital TFT LCD, Aspect Ratio: 16:10  
Input Signal VGA / HDMI 1.3a, Maximum Support Resolution  
1920x1080, Headphone Driver, 46mW@320, 5 Key Buttons Controls,  
9 Language OSD Menu, LED Backlight, Single Operation Voltage +12V,  
No accessory is included.

**MODEL: FCOPW1010**



**i-Tech Company LLC**

TOLL FREE: (888) 483-2418 • EMAIL: [info@itechlcd.com](mailto:info@itechlcd.com) • WEB: [www.iTechLCD.com](http://www.iTechLCD.com)



**Resistive Touch Panel**



**Projected Capacitive Touch**

## ***1. General Description***

### ***1.1 Features***

- 10.1" (1280x800) Digital TFT LCD
- Aspect Ratio: 16:10
- Input Signal VGA / HDMI 1.3a
- Maximum Support Resolution 1920x1080
- Headphone Driver, 46mW@32Ω
- 4W Resistive Touch Panel / 10 Points Projected Capacitive Touch
- 5 Key Buttons Controls
- 9 Language OSD Menu
- LED Backlight
- Single Operation Voltage +12V

### ***1.2 Applications***

- Industrial
- Medical Environment
- Instrument Display
- Kiosk
- Security
- Signage
- Office Electronics
- Home Application
- Educate Application



## 2. Contents

Contents	Page
<b>1. General Description.....</b>	<b>1</b>
1.1 Features	1
1.2 Applications	1
<b>2. Contents.....</b>	<b>2-3</b>
<b>3. Specifications.....</b>	<b>4</b>
<b>4. Block Diagram.....</b>	<b>4</b>
<b>5. Order Information.....</b>	<b>5</b>
5.1 Unit	5
<b>6. Accessories (Option).....</b>	<b>6</b>
<b>7. Operation manual / Connection.....</b>	<b>7</b>
7.1 Driver Board Manual	7
<b>8. Pin Description.....</b>	<b>8-10</b>
8.1 J101A : Pin Assignment of Power Input (DC-Jack Inside Diameter:2.1 $\phi$ Outside Diameter:5.5 $\phi$ Side Entry Type)	8
8.2 J702 : Pin Assignment of UART (Pitch 1.25mm 4Pin, Top Entry Type)	8
8.3 J801 : Pin Assignment of Analog RGB Input ( D-Sub 15Pin)	8
8.4 J401 : Pin Assignment of HDMI-A Type Input (HDMI 1.3a -19Pin Female)	9
8.5 J601C : Pin Assignment of Key Board (Pitch 1.25mm 12Pin , Side Entry Type)(Option)	9
8.6 J701A : Pin Assignment of Touch USB (USB A Type - Female 2.0mm, Side Entry Type )(Option)	10
8.7 J706B : Pin Assignment of Touch RS232 (Pitch 1.25mm 5Pin , Side Entry Type)(Option)	10
8.8 J301 : Pin Assignment of Line-Out/Ear Phone (Option) (Outside Diameter:3.5 $\phi$ Side Entry Type)	10
8.9 J302 : Pin Assignment of Line-In/Ear Phone (Option) (Outside Diameter:3.5 $\phi$ Side Entry Type)	10
<b>9. Absolute Maximum Ratings.....</b>	<b>11</b>
9.1 Absolute Maximum Ratings	11
<b>10. Recommended Operating Conditions.....</b>	<b>11-12</b>
10.1 Electrical Characteristics	11
10.2 VGA Mode Characteristics	12
<b>11. Touch Panel Characteristics.....</b>	<b>12-16</b>
<b>11.1 4W Resistance Touch Panel Characteristics</b>	<b>12-14</b>
11.1.1 Electrical Performance	12
11.1.2 Optical Performance	12
11.1.3 Mechanical Performance	12
11.1.4 Durability Performance	12
11.1.5 Resistive Touch Panel Integration Design Guide	13
11.1.6 Mechanical Design Notice For Resistive Touch Panel	14
11.1.7 Resistance Touch Panel Operation System Support	15
<b>11.2 Projected Capacitive Touch Panel Characteristics</b>	<b>16</b>



11.2.1 Electrical Performance	16
11.2.2 Optical Performance	16
11.2.3 Mechanical Performance	16
11.2.4 Projected Capacitive Touch Panel Operation System Support	16
<b>12. Key Function by OSD.....</b>	<b>17-20</b>
12.1 Menu Operation	17-20
<b>13. Dimension Information.....</b>	<b>21-23</b>
13.1 Unit (FCOPW1010)	21
<b>14. Installation Recommendations.....</b>	<b>22</b>
<b>15. Appendix.....</b>	<b>23</b>
14.1 TFT-LCD Mechanical Specifications	23
14.2 TFT-LCD Optical Characteristics	23
<b>16. Revision History.....</b>	<b>24</b>
16.1 Record of Revision	24

## 3. Specifications

LCD	
Panel Size	10.1"
Resolution (Pixels)	1280x800
Luminance without RTP	300 cd/m <sup>2</sup>
Luminance (RTP)	234cd/m <sup>2</sup>
Luminance (PCAP)	255 cd/m <sup>2</sup>
Contrast Ratio	800
View Angle	85 / 85 / 85 / 85
LED Life Time	20K (Min)
Power Requirement	
Power Input (DC Jack 2.1 $\phi$ )	+12 V <sub>DC</sub>
Power Consumption	6.16W (@Without Headphone Driver)
Touch Screen	
Resistive / PCAP Type	USB Interface
Resistive Type Support OS	Windows / Linux / DOS / Mac / QNX
Projected Capacitive Touch Support OS	Windows / Linux

Input Signal				
VGA	D-Sub15			
HDMI	1.3a			
Audio				
Headphone Driver (Line In & out)	46mW@32 $\Omega$ Phone Jack $\phi$ 3.5			
Controls				
Key	5 Buttons			
Serial Remote Control	UART / RS232 (Option)			
Environment				
	Without RTP	4W RTP	PCAP	
Temperature Range	Operating	0 ~ +50 $^{\circ}$ C	0 ~ +50 $^{\circ}$ C	0 ~ +50 $^{\circ}$ C
	Storage	-20 ~ +60 $^{\circ}$ C	-20 ~ +60 $^{\circ}$ C	-20 ~ +60 $^{\circ}$ C
High Temperature & High Humidity (Non-condensing)	Operating	+40 $^{\circ}$ C / 90%	+40 $^{\circ}$ C / 90%	+40 $^{\circ}$ C / 90%

## 4. Block Diagram

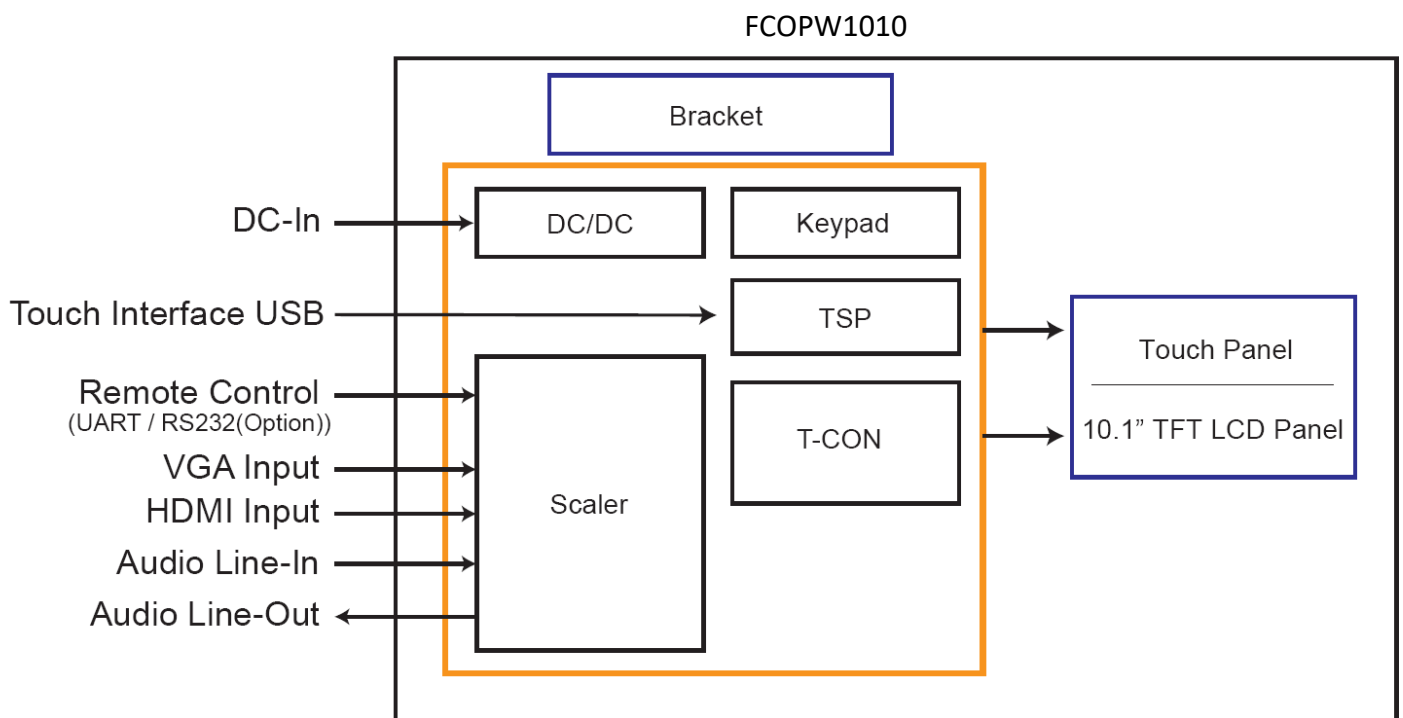



## 5. Order Information

### 5.1 Unit

Item	FCOPW1010			Unit	Remark
VGA	⊙				
HDMI	⊙				
Touch Panel Type	-				
Touch Screen Interface	-				
Headphone Driver (Line In & out)	⊙				
5 Keys	⊙				
UART Remote Control	⊙				
Dimensions	244.5 x 150.9 x 22.83			mm	
Weight	485.5			g	±10%
Condition	Standard				

**Note: 1.** The assembling of panel and bracket is aimed for delivery, packaging and experiment. If the demand of shockproof and long-term fix, pls. have it into consideration of mechanism design.

Item	Condition
RS232 Remote Control External Key	Customized

**Note:** Special order condition will apply to non-standard items and pls. contact salespersons in iTech.

## 6. Accessories (Option)

Before you begin installing the KIT, please make sure that the following materials have been shipped:



A.



B.



C.



D.



E.



F.

- A. AC to DC Adapter (L:1500mm,100-240V<sub>AC</sub> 50-60Hz to +12V<sub>DC</sub> @ 3.3A,  $\phi$  2.1)
- B. Power Cord (L:1800mm, Plug Type B for USA)
- C. HDMI Cable (L:1800mm)
- D. VGA Cable (L:1800mm)
- E. USB Cable (L:1800mm)
- F. AUDIO Cable (L:1800mm)
- G. Touch Screen Driver CD Disk / User Manual

## 7. Operation manual / Connection

### 7.1 Driver Board Manual

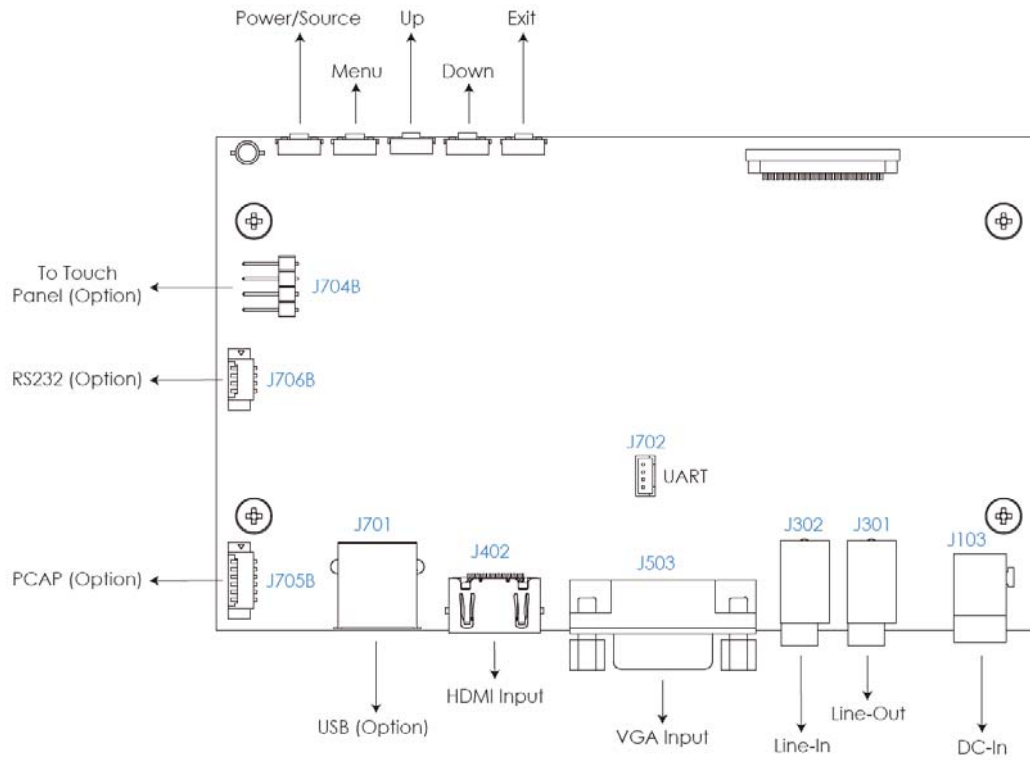



## 8. Pin Description

### 8.1 J101A : Pin Assignment of Power Input (DC-Jack Inside Diameter:2.1 ϕ Outside Diameter:5.5 ϕ Side Entry Type)

Pin No.	Symbol	I/O	Description	Remark
1	DC-In	I	+12Vdc Input Voltage	
2	GND	-	Power Ground	

### 8.2 J702 : Pin Assignment of UART (Pitch 1.25mm 4Pin, Top Entry Type)

※ Connector Part No.: MS24014 (STM) [Same as 53398-0471 (MOLEX)] ;

※ Matching Connector Part No.: P24014 (STM) [Same as 51021-0400 (MOLEX)].

Pin No.	Symbol	I/O	Description	Remark
1	TX / RS232 TX (Option)	O	UART / RS232 (Option) Transmission Data	
2	RX / RS232 RX (Option)	I	UART / RS232 (Option) Receive Data	
3	GND	-	Ground	
4	+3.3Vdc	O	+3.3Vdc Output Voltage	

Note: All Functions can be controlled by UART, About UART command list please contact sales.

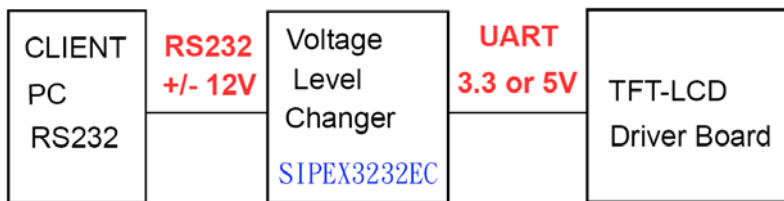

### 8.3 J801 : Pin Assignment of Analog RGB Input ( D-Sub 15Pin)

Pin No.	Symbol	I/O	Description	Remark
1	RI+	I	Analog Red Signal	
2	GI+	I	Analog Green Signal	
3	BI+	I	Analog Blue Signal	
4	GND	-	Ground	
5	VGA-Det	I	VGA Detect	
6	AGND	-	Analog Ground	
7	AGND	-	Analog Ground	
8	AGND	-	Analog Ground	
9	VGA5V	-	VGA +5Vdc Input	
10	GND	-	Ground	
11	GND	-	Ground	
12	VGA_SDA	-	DDC2 Data	
13	HS_IN	I	TTL Horizontal sync.	
14	VS_IN	I	TTL Vertical sync.	
15	VGA_SCL	-	DDC2 Clock	

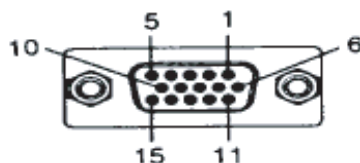

**8.4 J401 : Pin Assignment of HDMI-A Type Input (HDMI 1.3a -19Pin Female)**

Pin No.	Symbol	I/O	Description	Remark
1	DATA2+	I	Positive HDMI Input for B Link Data Channel 2	
2	DET_HDMI	-	HDMI Detect	
3	DATA2-	I	Negative HDMI Input for B Link Data Channel 2	
4	DATA1+	I	Positive HDMI Input for B Link Data Channel 1	
5	GND	-	Ground	
6	DATA1-	I	Negative HDMI Input for B Link Data Channel 1	
7	DATA0+	I	Positive HDMI Input for B Link Data Channel 0	
8	GND	-	Ground	
9	DATA0-	I	Negative HDMI Input for B Link Data Channel 0	
10	DCLK+	I	Positive HDMI Input for B Link Clock Channel	
11	GND	-	Ground	
12	DCLK-	I	Negative HDMI Input for B Link Clock Channel	
13	NC	-	No Connection	
14	NC	-	No Connection	
15	HDMI_SCL	I	DDC2 Clock	
16	HDMI_SDA	I	DDC2 Data	
17	GND	I	DDC/CEC Ground	
18	HDMI5V	I	HDMI +5Vdc Input	
19	HDMI_HPD	I	Hot Plug Detect	

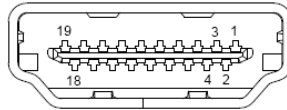

**8.5 J601C : Pin Assignment of Key Board (Pitch 1.25mm 12Pin , Side Entry Type)(Option)**

※ Connector Part No.: MS240112R (STM) [Same as 53261-1219 (MOLEX)] ;

※ Matching Connector Part No.: P240112 (STM) [Same as 51021-1200 (MOLEX)].

Pin No.	Symbol	I/O	Description	Remark
1	-	-	Don't Connect	
2	SW5	I	EXIT	
3	SW4	I	DOWN	
4	SW3	I	UP	
5	SW2	I	MENU / S	
6	SW1	I	POWER / SOURCE	
7	GND	-	Ground	
8	VDDP	-	+3.3Vdc Output Voltage	
9	-	-	Don't Connect	
10	RED	O	Indicator red LED for power off control	
11	GREEN	O	Indicator green LED for power on control	
12	GND	-	Ground	

**8.6 J701A : Pin Assignment of Touch USB (USB A Type - Female 2.0mm, Side Entry Type)(Option)**

Pin No.	Symbol	I/O	Description	Remark
1	VBUS	-	USB VCC	
2	D-	-	DATA (-)	
3	D+	-	DATA (+)	
4	DGND	-	Digital Ground	

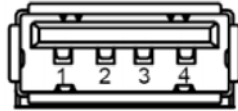

**8.7 J706B : Pin Assignment of Touch RS232 (Pitch 1.25mm 5Pin , Side Entry Type)(Option)**

※ Connector Part No.: MS24015R (STM) [Same as 53261-0519 (MOLEX)] ;

※ Matching Connector Part No.: P24015 (STM) [Same as 51021-0500 (MOLEX)].

Pin No.	Symbol	I/O	Description	Remark
1	VCC	-	RS232 VCC	
2	RXD	I	Receive Data	
3	TXD	O	Transmit Data	
4	GND	-	Ground	
5	NC	-	No Connection	

**8.8 J301 : Pin Assignment of Headphone Line-Out (Outside Diameter:3.5 φ Side Entry Type)**

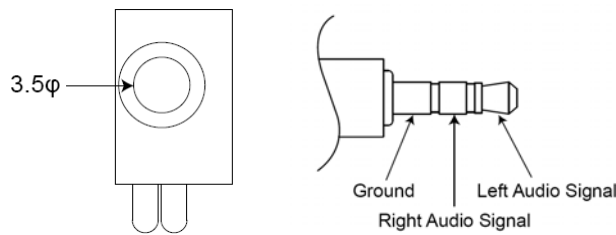

**8.9 J302 : Pin Assignment of Headphone Line-In (Outside Diameter:3.5 φ Side Entry Type)**

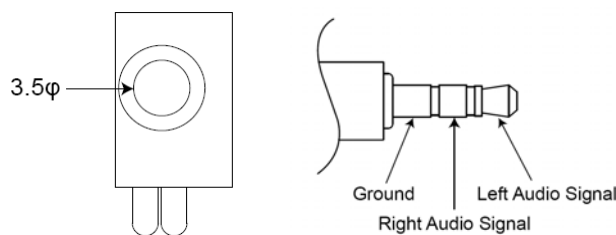



## 9. Absolute Maximum Ratings

### 9.1 Absolute Maximum Ratings

Parameter	Symbol	Min	Max	Unit	Remark
Input Voltage	V <sub>in</sub>	+11	+13.5	V	
Analog RGB Input Signal	Analog RGB in	0.5	2.0	V <sub>p-p</sub>	
Digital Input Signal	TTL	0.3	3.6	V	
HDMI Input Signal		-	165	MHz	
Operating Temp. without TP		0	+50	°C	
Storage Temp. without TP		-20	+60	°C	
Operating Temp. with 4W RTP		0	+50	°C	
Storage Temp. with 4W RTP		-20	+60	°C	
Operating Temp. with PCAP		0	+50	°C	
Storage Temp. with PCAP		-20	+60	°C	
High Temperature & High Humidity (Non-condensing) without TP		-	+40 / 90	°C / %	
High Temperature & High Humidity (Non-condensing) with 4W RTP		-	+40 / 90	°C / %	
High Temperature & High Humidity (Non-condensing) with PCAP		-	+40 / 90	°C / %	

## 10. Recommended Operating Conditions

### 10.1 Electrical Characteristics

Parameter	Symbol	I/O	Min	Typ	Max	Unit	Note
Input Voltage	DC-in	I	+11.5	+12	+13	V	
Total Current	I-in	I	-	580	-	mA	+12V
Power Consumption		I	-	6.96	-	W	±15% @Without Headphone
Output Voltage	VDD	O	3.2	3.3	3.4	V	
Analog RGB Input Signal	Analog RGB in	RGB	I	0.7	-	V <sub>p-p</sub>	@75Ω
HDMI Input Signal			-	-	165	MHz	



## 10.2 VGA Mode Characteristics

Dots per inch	H	Unit	Polarity	V	Unit	Polarity	Note
640 × 480	31.47	KHz	Positive	59.9	Hz	Positive	
800 × 600	37.88	KHz	Positive	60.3	Hz	Positive	
1024 × 768	48.36	KHz	Positive	60	Hz	Positive	
1280 × 800	49.2	KHz	Positive	59.7	Hz	Positive	
1280 × 1024	63.98	KHz	Positive	60	Hz	Positive	
1600 × 1200	75	KHz	Positive	60	Hz	Positive	
1920 × 1080	67.5	KHz	Positive	60	Hz	Positive	

## 11. Touch Panel Characteristics

### 11.1 4W Resistance Touch Panel Characteristics

#### -11.1.1 Electrical Performance

Parameter	Symbol	Min	Typ	Max	Unit	Note
Terminal Resistance	X	300		1000	Ω	
	Y	100		450	Ω	
Linearity				1.5	%	
Insulation Impedance		20			MΩ	DC 25V
Response Time				15	ms	

#### -11.1.2 Optical Performance

Parameter	Specifications
Light Transmittance	78% ±2%
Haze	6.5%±2%

#### -11.1.3 Mechanical Performance

Parameter	Specifications
Input Method	Stylus or Finger
Operating Force	R0.8 Silicon Rubber, 20~150 gf
Surface Hardness	3H pencil

#### -11.1.4 Durability Performance

Parameter	Specifications
Knock Test	≥ 1,000,000 times
Pen Sliding Test	≥ 100,000 times

-11.1.5 Resistive Touch Panel Integration Design Guide

Avoid the design that Front-case overlap and press on the active area of the touch-panel.

Give enough gap (over 0.5mm at compressed) between the front case and touch-panel to protect wrong operating.

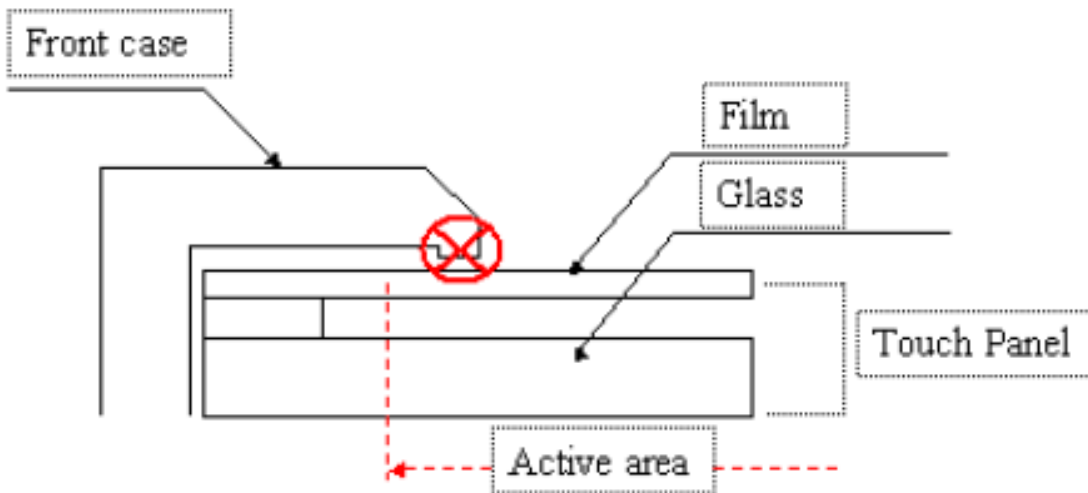



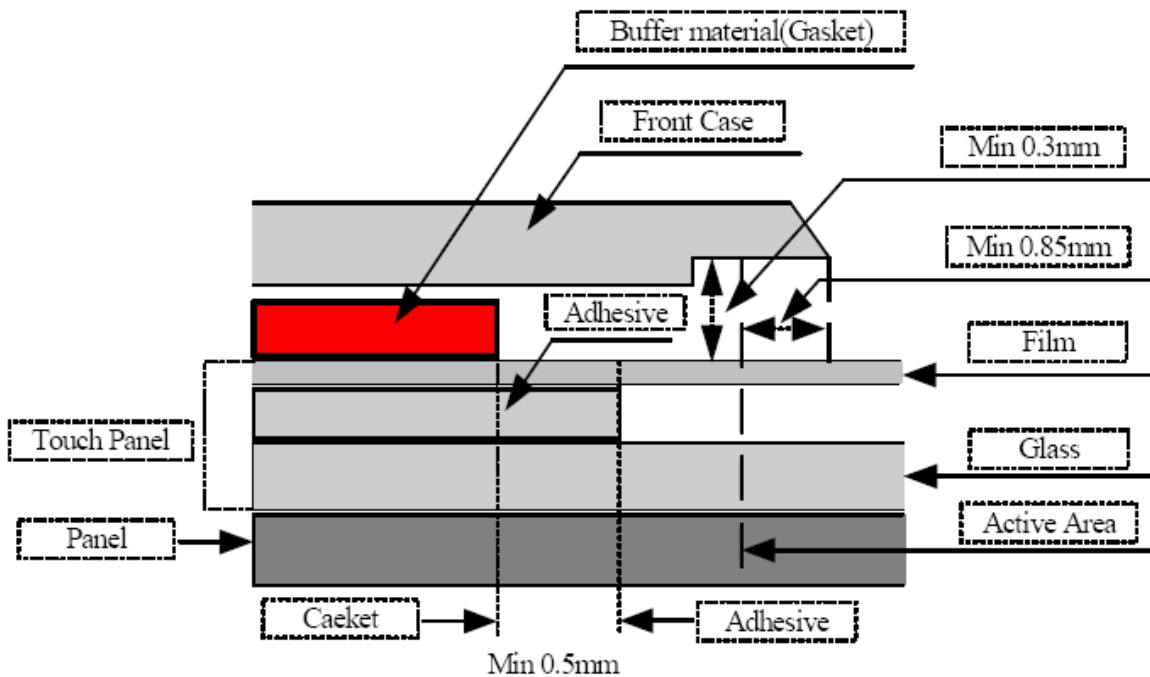

Use a buffer material (Gasket) between the touch-panel and front-case to protect damage and wrong operating.

Avoid the design that buffer material overlap and press on the inside of touch-panel viewing area.

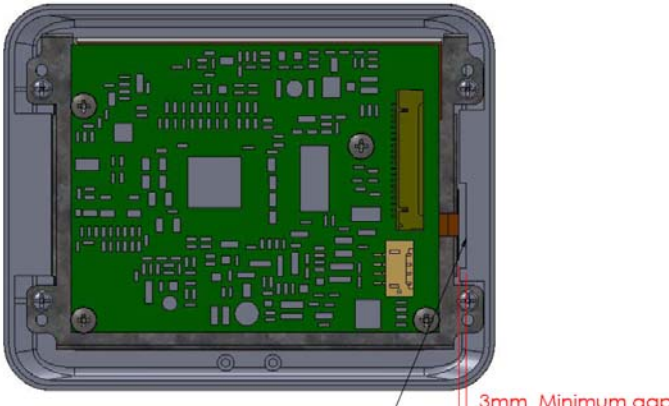
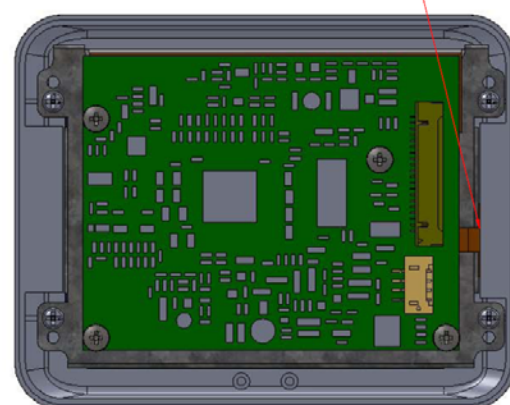
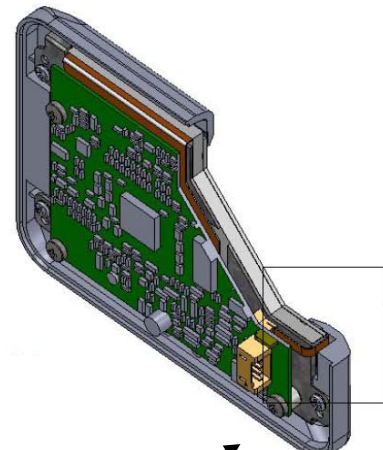
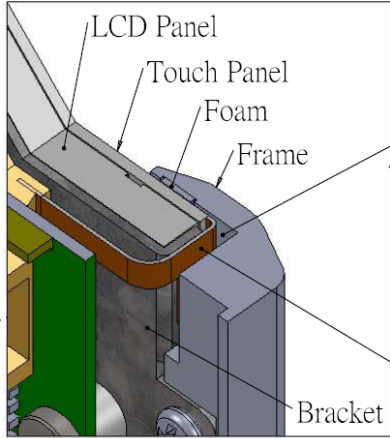

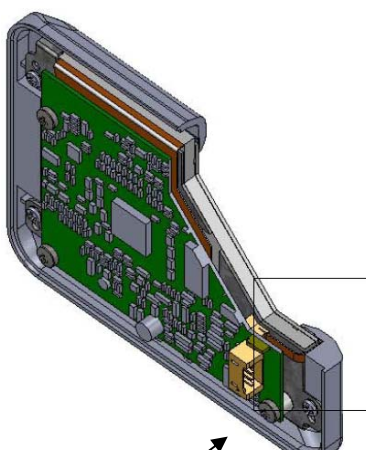
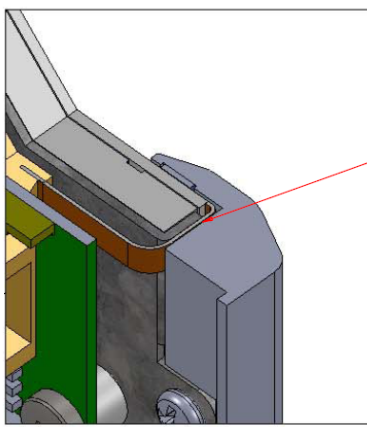
## -11.1.6 Mechanical Design Notice For Resistive Touch Panel

Correct Installation	Incorrect Installation
 <p data-bbox="159 795 478 840">&lt;Correct Installation&gt;</p> <p data-bbox="558 761 766 795">3mm Minimum gap</p>	 <p data-bbox="957 369 1308 414">&lt;Incorrect Installation&gt;</p>
 <p data-bbox="399 1400 766 1444">&lt;Correct Installation&gt;</p> <div data-bbox="87 1456 478 1892">  <p data-bbox="159 1467 319 1500">LCD Panel</p> <p data-bbox="207 1512 335 1545">Touch Panel</p> <p data-bbox="255 1556 335 1590">Foam</p> <p data-bbox="287 1601 367 1635">Frame</p> <p data-bbox="367 1848 462 1881">Bracket</p> <p data-bbox="494 1814 718 1848">FPC to Touch Panel</p> <p data-bbox="223 1892 319 1926">Zoom-In</p> </div> <p data-bbox="478 1568 782 1724">  Frame can not surpress on LCD Panel and FPC to Touch Panel         </p>	 <p data-bbox="1117 1411 1500 1456">&lt;Incorrect Installation&gt;</p> <div data-bbox="813 1456 1181 1881">  <p data-bbox="1197 1568 1260 1635">  </p> <p data-bbox="1212 1646 1484 1747">Supression on FPC to Touch Panel causes the fracture.</p> </div> <p data-bbox="957 1881 1053 1915">Zoom-In</p>



## -11.1.7 Resistance Touch Panel Operation System Support

**Driver Vender : EETI (eGalax\_eMPIA Technology Inc.)**

OS	Version	Interface
<b>Windows</b>	Windows 7, 8, 8.1, 10	USB/RS232
	Windows Embedded 7, 8	
	Windows Embedded POSReady 2009	
	Windows , XP, 2000	
	Windows XP Embedded	
<b>Windows CE</b>	Windows Embedded Compact 2013	USB/RS232
	Windows Embedded Compact 7	
	Windows CE 6.0	
	Windows CE.Net (4.x / 5.0)	
<b>Linux</b>	Kernel 2.6.24 Upward and 3.x.x (X86 / ARM / MIPS)	USB
	Kernel 2.6.23 Downward (X86)	
	Kernel 2.4.x (x86)	
<b>Android</b>	Android Version 2.3.x upwards (X86 / ARM / MIPS)	USB
<b>Mac OS</b>	Mac OS X 10.5.3 Leopard (Power PC)	USB
	Mac OS X 10.7.4 Earlier (32Bit) (Intel CPU)	
	Mac OS X 10.7.4 Earlier (64Bit) (Intel CPU)	
	Mac OS X 10.7.5 (32Bit) (Intel CPU)	
	Mac OS X 10.7.5 (64bit) (Intel CPU)	
	Mac OS X 10.8.x Mountain Lion (Intel CPU)	
	Mac OS X 10.9.x Mavericks (Intel CPU)	
	Mac OS X 10.10.x Yosemite (Intel CPU)	
<b>QNX</b>	QNX Neutrino RTOS V6.5/6.4	USB/RS232
	QNX Neutrino RTOS V6.3	

**Note: 1. How to use Touch Driver, please refer to Readme of Touch Screen Driver CD Disk.**

**2. Please refer to the website for the latest driver version and support operating system.**

**Website:** <http://www.itechlcd.com>





## 11.2 Projected Capacitive Touch Panel Characteristics

### -11.2.1 Electrical Performance

Parameter	Symbol	Min	Typ	Max	Unit	Note
Operating Voltage		-	-	5V		

### -11.2.2 Optical Performance

Parameter	Specifications
Light Transmittance	Min 85%

### -11.2.3 Mechanical Performance

Parameter	Specifications
Input Method	Finger
Touch Function	10 Points
Interface	USB
Surface Hardness	7H
Cover Spec.	T=1.2mm Black Printing
Knock Test	≥ 1,000,000 times

### -11.2.4 Projected Capacitive Touch Panel Operation System Support

Driver Vender : ITE (ITE Tech. Inc.)

OS	Version	Interface
Windows	Windows 7	USB
	Windows 8 / 8.1	
Linux	Kernel 3.0.8 and above	USB

**Note: 1. How to use Touch Driver, please refer to Readme of Touch Screen Driver CD Disk.**

**2. Please refer to the website for the latest driver version and support operating system.**

**Website:** <http://www.itechlcd.com>

## 12. Key Function by OSD

### 12.1 Menu Operation

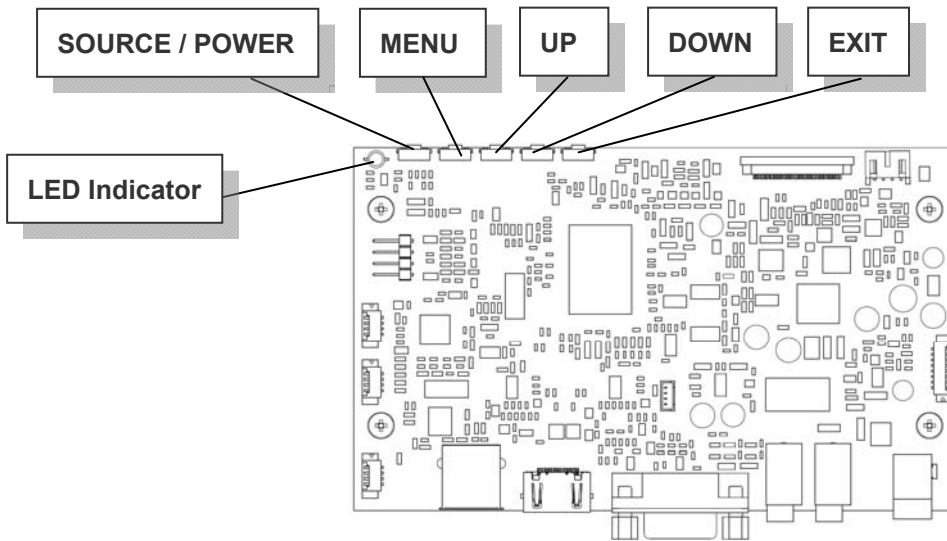

### OSD ICON Instructions :

1. POWER : Power On/Off (※Press for 3 secs to turn off)
2. MENU / ENTER : (After turning on MENU, only ENTER is available)
3. UP : Move Upward / Increase Value / Option Switch
4. DOWN : Move Downward / Decrease Value / Option Switch
5. EXIT : Return to Previous Page
6. LED Indicator
  - Waiting : Flickering Green
  - Power ON : Green
  - Power OFF : Red

### Save OSD Setting:



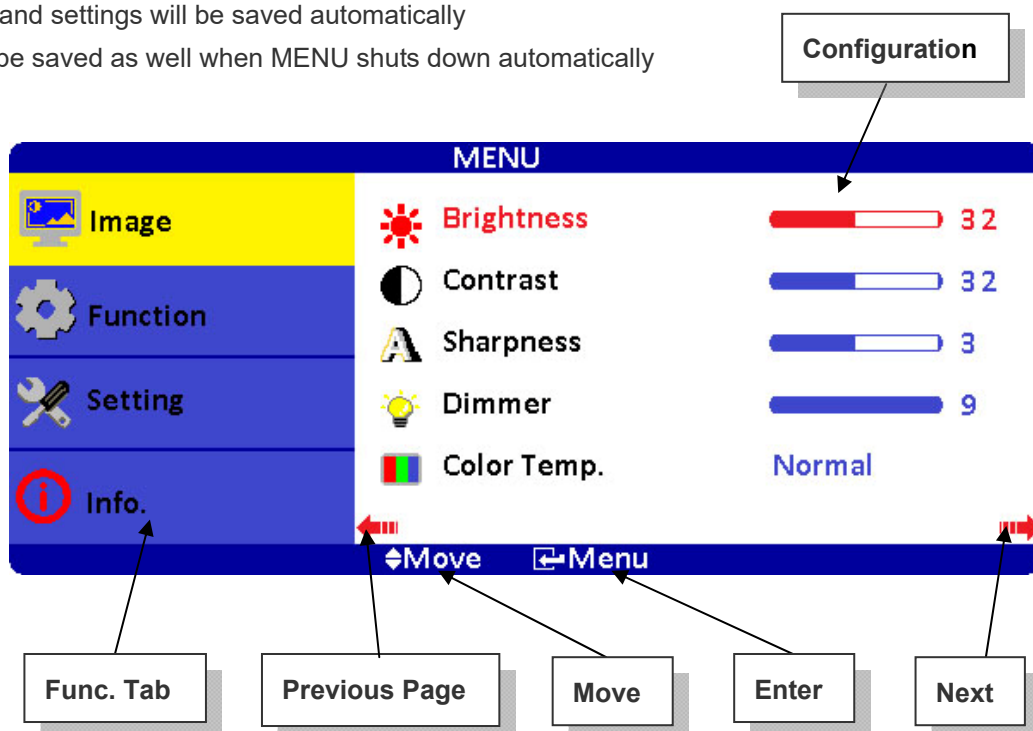







1. EXIT MENU and settings will be saved automatically
2. Settings will be saved as well when MENU shuts down automatically



## Overview of the Menu :









### Image

Indicator	Meaning	Default	Adjustable range	Remark
	Brightness	32	0~63	Adjust-Bar
	Contrast	32	0~63	Adjust-Bar
	Sharpness	3	1~5	Adjust-Bar
	Dimmer	15	0~15	Adjust-Bar
	Color Temp.	Normal	Normal / Warm / Cool	
	H-Position	0	-25~+25	VGA only
	V-Position	0	-25~+25	VGA only
	Clock	0	-25~+25	VGA only
	Phase	32	0~63	VGA only
	Auto	By different resolution		VGA only
	Exit			



### Function

ICON	Meaning	Default	Adjustable range	Function	Remark
	Show Status	On	On / Off	Information of input source	ON: Show ; OFF: Hidden
	Blue Screen	On	On / Off	No signal input shows blue or black screen.	ON: Blue ; OFF: Black
	Auto Power On	On	On / Off	Modules turns on automatically without power key input.	ON: Auto ; OFF: Manual
	Detect Source	On	On / Off	Auto detect input source.	ON: Auto ; OFF: Normal
	Auto Power Saving	Off	6s / 15s / 30s / Off	Modules go ready when no input source is detected.	ON: Auto ; OFF: Normal
	Auto Sleep	Off	15M / 30M / 60M / Off	Modules go sleep when set timing is out.	ON: Auto ; OFF: Normal
	Exit				

**Note :** After configuration is set, RESET won't restore to default setting.



## Setting

Indicator	Meaning	Default	Adjustable range	Remark
	Source	VGA	VGA / HDMI	
	Volume	32	0~63	
	Mute	Off	On / Off	On : Mute · Off : Sound
	Language	English	English / 中文 / 日本語 / 한국의 / Française / Deutsch / Italiano / Española / Português	
	Reset			Restore to default
	Exit			



## Info.

**MENU**

Image	Source : VGA Resolution : 1280×800
Function	H-Position : 49.2KHz V-Position : 59.7Hz
Setting	Program Ver : 1.00 Command Ver : 1.00
Information	

⬅️ Move    ⬅️ Exit / Menu    ➡️

## Hot Key When OSD Menu is Off :

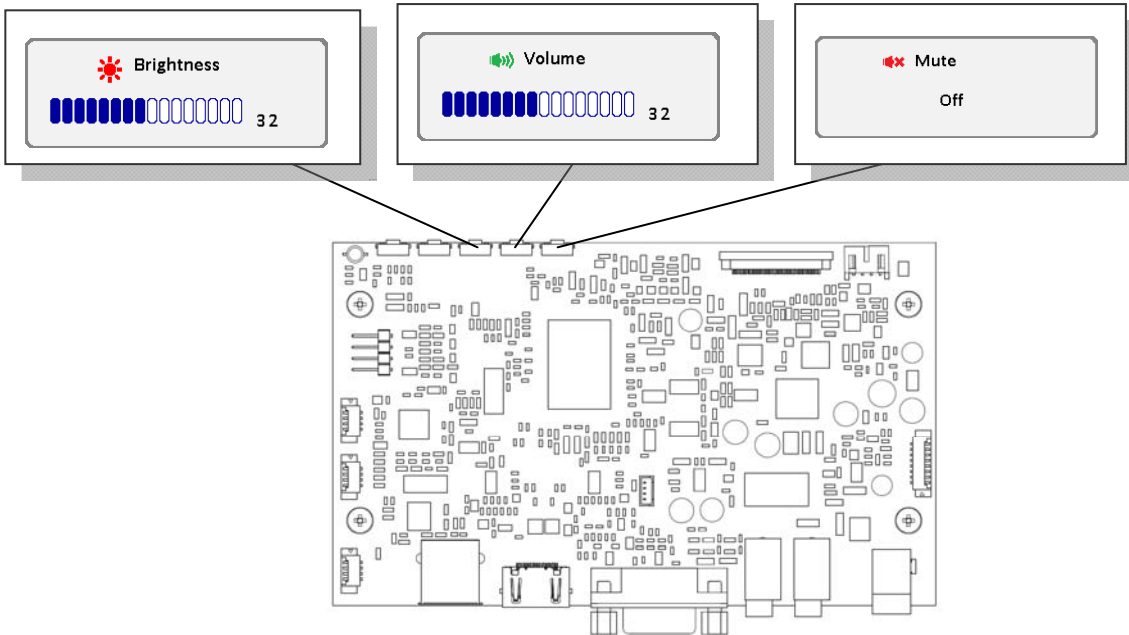

## Information of Input Source and Functionality :

The screenshot shows a Windows desktop with the following information:

- Input Source:** A callout box points to the 'VGA' icon in the system tray, which displays 'VGA 1280x800'.
- Resolution:** A callout box points to the '1280x800' text in the system tray.
- Detect Source Remaining Secs:** A callout box points to the '5' in the 'Detect Source 5' indicator.
- VGA Mode Remaining Secs:** A callout box points to the '1' in the 'VGA 1' indicator.

[Source] : Input Signal Switch

## Overview of Input Signals :

Indicator	Interface
	VGA
	HDMI

## 13. Dimension Information

### 13.1 Unit (FCOPW1010)

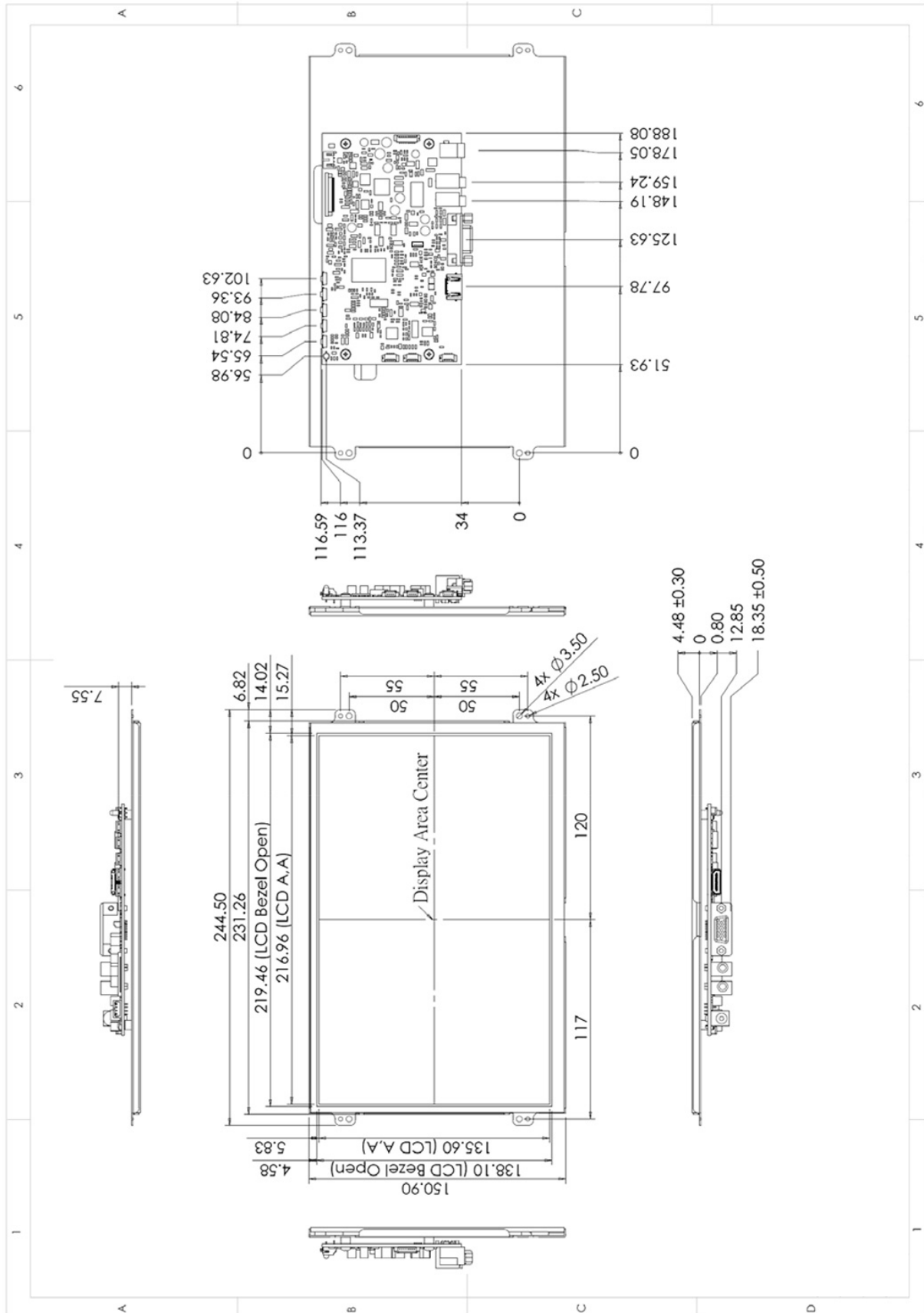

## 14. Installation Recommendations

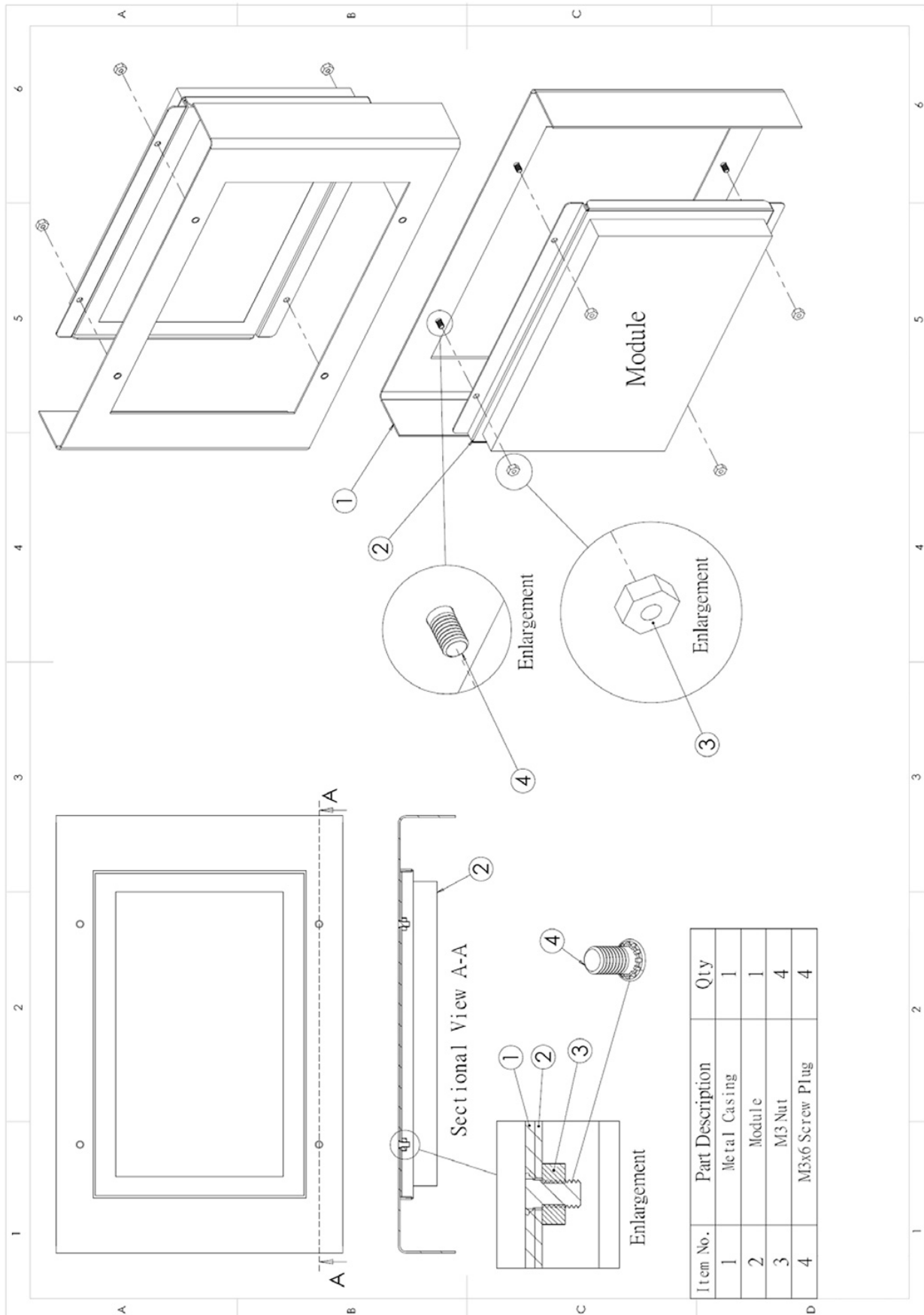



## 15. Appendix

### 15.1 TFT-LCD Mechanical Specifications

Parameter	Specifications	Unit
Screen Size	10.1 (diagonal)	Inch
Display Format	1280 x (R.G.B) x 800	Dot
Active Area	216.96 (H)× 135.6(V)	mm
Pixel Pitch	0.1695(H) x 0.1695(V)	mm
Pixel Arrangement	RGB stripe	

### 15.2 TFT-LCD Optical Characteristics

Parameter	Symbol	Condition	Min	Typ	Max	Unit	Remark
Viewing Angle	Horizontal	Left	75	85	---	deg	
		Right	75	85	---	deg	
	Vertical	Top	75	85	---	deg	
		Bottom	75	85	---	deg	
Contrast Ratio	CR	At optimized Viewing angle	600	800	---	---	
Luminance without RTP	L		250	300	---	cd/m <sup>2</sup>	
LED Life Time		25°C	20000	---	---	Hrs	Note

Note: The "LED Life Time" is defined as the module brightness decrease to 50% original.





## 16. Revision History

### 16.1 Record of Revision

NO	Date	Description	Page	Note
1.0	August 30, 2018	· First draft	25	