

SPECIFICATION APPROVAL SHEET

Open Frame 15.6" (1366x768) Digital TFT LCD 300nits Contrast Ratio 500, Viewing 80/80/80/80, Aspect Ratio: 16:9, Input Signal VGA / DVI-D/ HDMI 1.3a, Maximum Support Resolution 1920x1080, Stereo Audio Amplifier, Output 2W@4Ω Speaker, Audio Line-In, Projected Capacitive Touch USB controller, 5 Key Buttons Control, 9 Language OSD Menu, LED Backlight, Signal Operation Voltage +12V, No cables, no accessories, no Power adapter.

MODEL: FCOPW1560-PCAP



i-Tech Company LLC

TOLL FREE: (888) 483-2418 • EMAIL: info@itechlcd.com • WEB: www.iTechLCD.com



Resistive Touch Panel



Projected Capacitive Touch

1. General Description

1.1 Features

- 15.6" (1366x768) Digital TFT LCD
- Aspect Ratio: 16:9
- Input Signal VGA / DVI-D/ HDMI 1.3a
- Maximum Support Resolution 1920x1080
- Stereo Audio Amplifier, Output 2W@4Ω Speaker
- Audio Line-In
- 5W Resistive Touch Panel / Projected Capacitive Touch
- 5 Key Buttons Control
- 9 Language OSD Menu
- LED Backlight
- Signal Operation Voltage +12V

1.2 Applications

- Industrial
- Medical Environment
- Instrument Display
- Kiosk
- Security
- Signage
- Office Electronics
- Home Application
- Educate Application



2. Contents

Contents	Page
1. General Description	1
1.1 Features	1
1.2 Applications	1
2.Contents	2-3
3. Specifications	4
4. Block Diagram	4
5. Order Information	5
5.1 Unit	5
6. Accessories (Option)	6
7. Operation manual / Connection	7
7.1 Driver Board Manual	7
8. Pin Description	8-11
8.1 J103 : Pin Assignment of Power Input (DC-Jack Inside Diameter:2.1 μ Outside Diameter:5.5 μ Side Entry Type)	8
8.2 J702 : Pin Assignment of UART (Pitch 1.25mm 4Pin, Top Entry Type)	8
8.3 J503 : Pin Assignment of Analog RGB Input (D-Sub 15Pin)	8
8.4 J401 : Pin Assignment of DVI-D (24 Pin)	9
8.5 J402 : Pin Assignment of HDMI-A Type Input (HDMI 1.3a -19Pin Female)	10
8.6 J303 : Pin Assignment of Speaker Left (Pitch 2.0mm 2Pin , Top Entry Type)	10
8.7 J302 : Pin Assignment of Speaker Right (Pitch 2.0mm 2Pin , Top Entry Type)	10
8.8 J701 : Pin Assignment of Touch USB (USB A Type - Female 2.0mm, Side Entry Type)(Option)	11
8.9 J705 : Pin Assignment of Touch RS232 (D-SUB 9 Male)(Option)	11
8.10 J301 : Pin Assignment of Line-In/Ear Phone (Option) (Outside Diameter:3.5 ϕ Side Entry Type)	11
9. Absolute Maximum Ratings	12
9.1 Absolute Maximum Ratings	12
10. Recommended Operating Conditions	12-13
10.1 Electrical Characteristics	12
10.2 VGA Mode Characteristics	13
11. Touch Panel Characteristics	13-16
11.1 5W Resistance Touch Panel Characteristics	13-15
11.1.1 Electrical Performance	13
11.1.2 Optical Performance	13
11.1.3 Mechanical Performance	13
11.1.4 Durability Performance	13
11.1.5 Resistive Touch Panel Integration Design Guide	14
11.1.6 Mechanical Design Notice For Resistive Touch Panel	15
11.1.7 Resistive Touch Panel Operation System Support	16

11.2 Projected Capacitive Touch Panel Characteristics	17
11.2.1 Electrical Performance	17
11.2.2 Optical Performance	17
11.2.3 Mechanical Performance	17
11.2.4 Projected Capacitive Touch Panel Operation System Support	17
<i>12. Key Function by OSD.....</i>	18-21
12.1 Menu Operation	18-21
<i>13. Dimension Information.....</i>	22-25
13.1 Unit (FCOPW1560-PCAP)	22
<i>14. Appendix.....</i>	23
14.1 TFT-LCD Mechanical Specifications	23
14.2 TFT-LCD Optical Characteristics	23

3. Specifications

LCD	
Panel Size	15.6"
Resolution (Pixels)	1366x768
Color	16.7M
Luminance without TP	300 cd/m ²
Luminance (RTP)	234cd/m ²
Luminance (PCAP)	240cd/m ²
Contrast Ratio	500
View Angle	80 / 80 / 80 / 80
LED Life Time	50K (Min)
Power Requirement	
Power Input (DC Jack 2.1 ϕ)	+12 V _{DC}
Power Consumption@+12V	12.7Watts (@Without Amplifier)
Touch Screen	
Resistive Type	USB/RS232 Interface
Resistive Type Support OS	Windows / Linux / DOS / Mac / QNX
PCAP Type	USB Interface
Projected Capacitive Touch Support OS	Windows / Linux

Input Signal			
VGA	D-Sub15		
DVI	DVI-D		
HDMI	1.3a		
Audio			
Amplifier	1W@8 Ω / 2W@4 Ω		
Line-In	Stereo Input Phone Jack ϕ 3.5		
Controls			
Key	5 Buttons		
Serial Remote Control	UART / RS232 (Option)		
Environment			
	Without RTP	5W RTP	PCAP
Temperature Range	Operating	0~+60 $^{\circ}$ C	-0~+60 $^{\circ}$ C
	Storage	-20~+60 $^{\circ}$ C	-20~+60 $^{\circ}$ C
High Temperature & High Humidity (Non-condensing)	Operating	+50 $^{\circ}$ C / 80%	+50 $^{\circ}$ C / 80%

4. Block Diagram

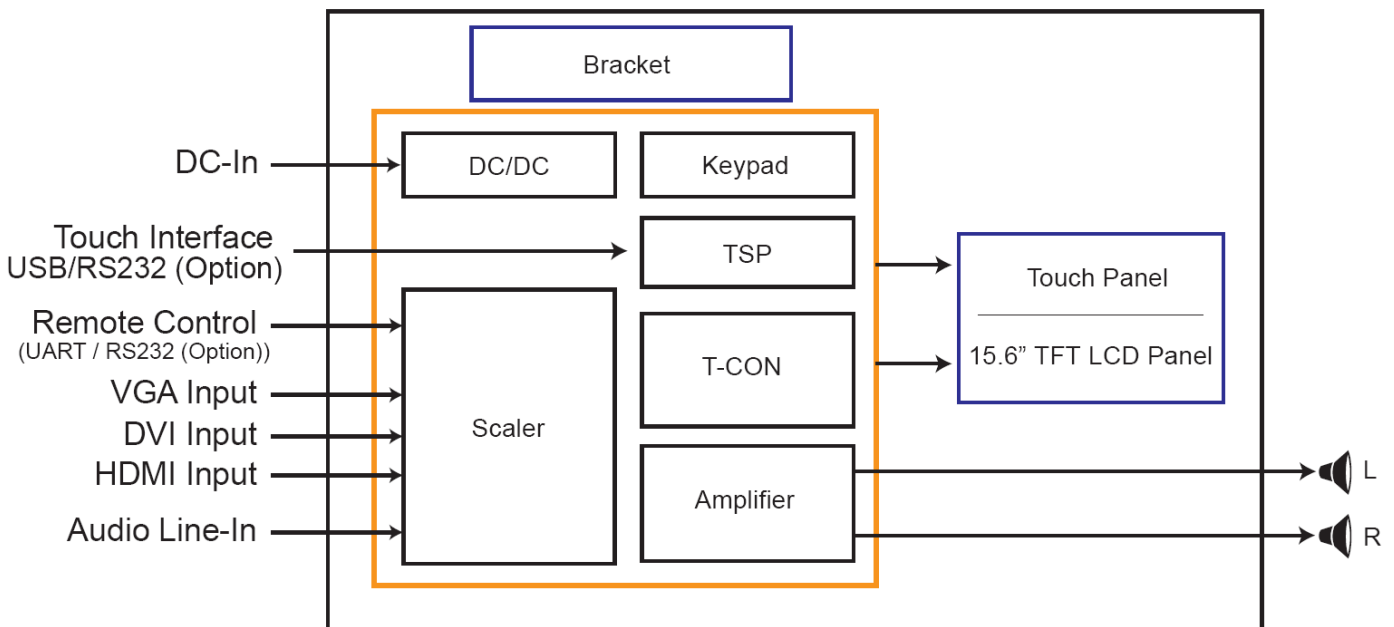

5. Order Information

5.1 Unit

Item	FCOPW1560-PCAP			Unit	Remark
VGA	◎				
DVI	◎				
HDMI	◎				
Touch Panel Type	Projected Capacitive Touch				
Touch Screen Interface	USB				
Audio Amplifier	◎				
Audio Line-In	◎				
5 Keys	◎				
UART Remote Control	◎				
Dimensions	401.6 x 269 x 43.08			mm	
Weight	2460			g	±10%
Condition	Standard				

Note: The assembling of panel and bracket is aimed for delivery, packaging and experiment. If the demand of shockproof and long-term fix, pls. have it into consideration of mechanism design.

Item	Condition
Ear Phone	Customized
RS232 Remote Control	
Back Cover	
External Key	
Light Sensor	

Note: Special order condition will apply to non-standard items and pls. contact salespersons in iTech.

6. Accessories (Option)

Before you begin installing the KIT, please make sure that the following materials have been shipped:



A.



B.



C.



D.



E.



F.



G.



H.



I.

- A. AC to DC Adapter (L:1500mm,100-240V_{AC} 50-60Hz to +12V_{DC} @ 3.3A, ϕ 2.1)
- B. Power Cord (L:1800mm, Plug Type B for USA)
- C. HDMI Cable (L:1800mm)
- D. DVI Cable (L:1800mm)
- E. VGA Cable (L:1800mm)
- F. USB Cable (L:1800mm)
- G. RS232 Cable (L:1800mm, Null Modem)
- H. AUDIO Cable (L:1800mm)
- I. Speaker (2.5W @ 4 Ω L:400mm *2 Pieces)

7. Operation manual / Connection

7.1 Driver Board Manual

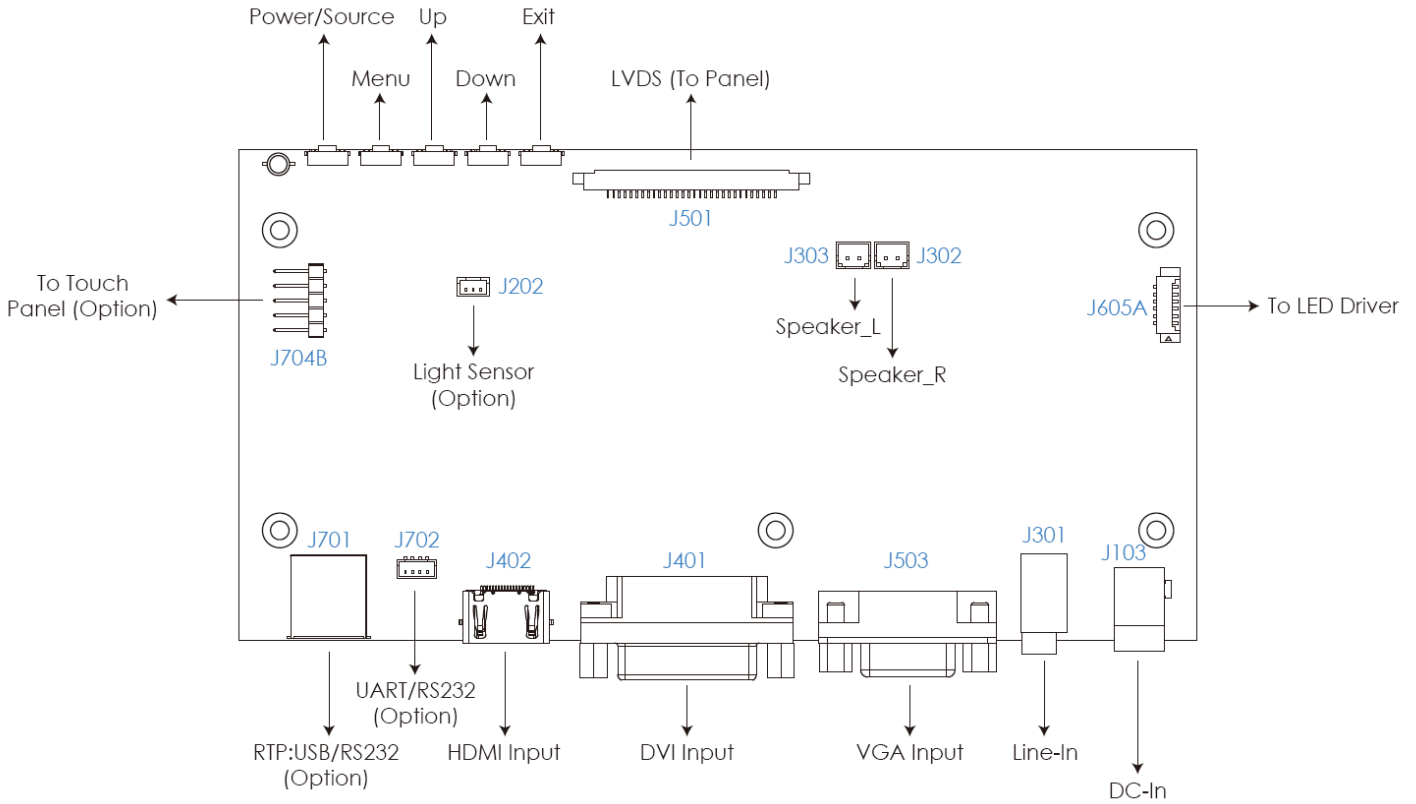

8. Pin Description

8.1 J103 : Pin Assignment of Power Input (DC-Jack Inside Diameter:2.1 ϕ Outside Diameter:5.5 ϕ Side Entry Type)

Pin No.	Symbol	I/O	Description	Remark
1	DC-In	I	+12Vdc Input Voltage	
2	GND	-	Power Ground	

8.2 J702: Pin Assignment of UART (Pitch 1.25mm 4Pin, Top Entry Type)

※ Connector Part No.: MS24014 (STM) [Same as 53398-0471 (MOLEX)] ;

※ Matching Connector Part No.: P24014 (STM) [Same as 51021-0400 (MOLEX)].

Pin No.	Symbol	I/O	Description	Remark
1	TX / RS232 TX (Option)	O	UART / RS232 (Option) Transmission Data	
2	RX / RS232 RX (Option)	I	UART / RS232 (Option) Receive Data	
3	GND	-	Ground	
4	+3.3Vdc	O	+3.3Vdc Output Voltage	

Note: All Functions can be controlled by UART , About UART command list please contact iTech sales.

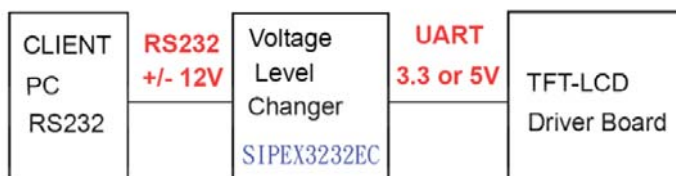

8.3 J503 : Pin Assignment of Analog RGB Input (D-Sub 15Pin)

Pin No.	Symbol	I/O	Description	Remark
1	RI+	I	Analog Red Signal	
2	GI+	I	Analog Green Signal	
3	BI+	I	Analog Blue Signal	
4	GND	-	Ground	
5	VGA-Det	I	VGA Detect	
6	AGND	-	Analog Ground	
7	AGND	-	Analog Ground	
8	AGND	-	Analog Ground	
9	VGA5V	-	VGA +5Vdc Input	
10	GND	-	Ground	
11	GND	-	Ground	
12	VGA_SDA	-	DDC2 Data	
13	HS_IN	I	TTL Horizontal sync.	
14	VS_IN	I	TTL Vertical sync.	
15	VGA_SCL	-	DDC2 Clock	

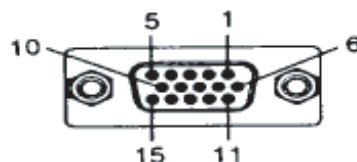

8.4 J401 : Pin Assignment of DVI-D (24 Pin)

Pin No.	Symbol	I/O	Description	Remark
1	DATA2-	I	Negative DVI Input for A Link Data Channel 2	
2	DATA2+	I	Positive DVI Input for A Link Data Channel 2	
3	GND	-	Ground	
4	NC	-	No Connection	
5	NC	-	No Connection	
6	DVI_SCL	I	DDC2 Clock	
7	DVI_SDA	I	DDC2 Data	
8	NC	-	No Connection	
9	DATA1-	I	Negative DVI Input for A Link Data Channel 1	
10	DATA1+	I	Positive DVI Input for A Link Data Channel 1	
11	GND	-	Ground	
12	NC	-	No Connection	
13	NC	-	No Connection	
14	DVI5V	I	DVI +5Vdc Input	
15	DET_DVI	I	DVI Detect	
16	DVI_HPD	-	Hot Plug Detect	
17	DATA0-	I	Negative DVI Input for A Link Data Channel 0	
18	DATA0+	I	Positive DVI Input for A Link Data Channel 0	
19	GND	-	Ground	
20	NC	-	No Connection	
21	NC	-	No Connection	
22	GND	-	Ground	
23	DCLK+	I	Positive DVI Input for A Link Clock Channel	
24	DCLK-	I	Negative DVI Input for A Link Clock Channel	

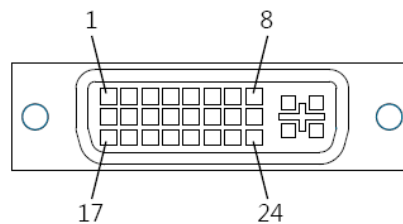

8.5 J402 : Pin Assignment of HDMI-A Type Input (HDMI 1.3a -19Pin Female)

Pin No.	Symbol	I/O	Description	Remark
1	DATA2+	I	Positive HDMI Input for B Link Data Channel 2	
2	DET_HDMI	-	HDMI Detect	
3	DATA2-	I	Negative HDMI Input for B Link Data Channel 2	
4	DATA1+	I	Positive HDMI Input for B Link Data Channel 1	
5	GND	-	Ground	
6	DATA1-	I	Negative HDMI Input for B Link Data Channel 1	
7	DATA0+	I	Positive HDMI Input for B Link Data Channel 0	
8	GND	-	Ground	
9	DATA0-	I	Negative HDMI Input for B Link Data Channel 0	
10	DCLK+	I	Positive HDMI Input for B Link Clock Channel	
11	GND	-	Ground	
12	DCLK-	I	Negative HDMI Input for B Link Clock Channel	
13	NC	-	No Connection	
14	NC	-	No Connection	
15	HDMI_SCL	I	DDC2 Clock	
16	HDMI_SDA	I	DDC2 Data	
17	GND	I	DDC/CEC Ground	
18	HDMI5V	I	HDMI +5Vdc Input	
19	HDMI_HPD	I	Hot Plug Detect	

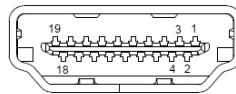

8.6 J303 : Pin Assignment of Speaker Left (Pitch 2.0mm 2Pin , Top Entry Type)

※ Connector Part No.: A2001WV2-2P(JWT) ;

※ Matching Connector Part No.: A2001H02-2P(JWT) .

Pin No.	Symbol	I/O	Description	Remark
1	+LOUT	O	Left Speaker Out+	
2	-LOUT	O	Left Speaker Out -	

8.7 J302 : Pin Assignment of Speaker Right (Pitch 2.0mm 2Pin , Top Entry Type)

※ Connector Part No.: A2001WV2-2P(JWT) ;

※ Matching Connector Part No.: A2001H02-2P(JWT) .

Pin No.	Symbol	I/O	Description	Remark
1	+ROUT	O	Right Speaker Out+	
2	-ROUT	O	Right Speaker Out-	

8.8 J701 : Pin Assignment of Touch USB (USB A Type - Female 2.0mm, Side Entry Type)(Option)

Pin No.	Symbol	I/O	Description	Remark
1	VBUS	-	USB VCC	
2	D-	-	DATA (-)	
3	D+	-	DATA (+)	
4	DGND	-	Digital Ground	

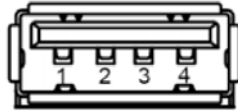

8.9 J705 : Pin Assignment of Touch RS232 (D-SUB 9 Male)(Option)

Pin No.	Symbol	I/O	Description	Remark
1	-	-	Don't Connect	
2	RXD	I	Receive Data	
3	TXD	O	Transmit Data	
4	-	-	Don't Connect	
5	GND	-	Ground	
6	NC	-	No Connection	
7	NC	-	No Connection	
8	-	-	Don't Connect	
9	-	-	Don't Connect	

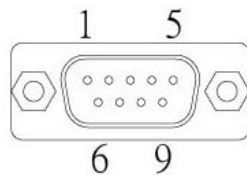

8.10 J301 : Pin Assignment of Line-In/Ear Phone (Option) (Outside Diameter:3.5 φSide Entry Type)

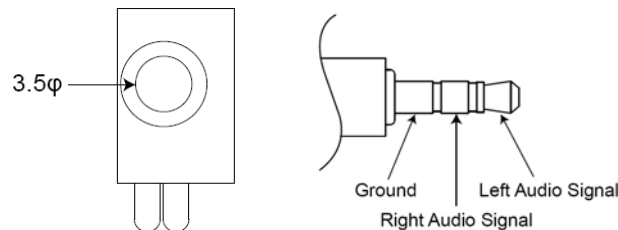



9. Absolute Maximum Ratings

9.1 Absolute Maximum Ratings

Parameter	Symbol	Min	Max	Unit	Remark
Input Voltage	Vin	+10.8	+13.2	V	
Analog RGB Input Signal	Analog RGB in	0.5	2.0	Vp-p	
Digital Input Signal	TTL	0.3	3.6	V	
DVI Input Signal		-	165	MHz	
HDMI Input Signal		-	165	MHz	
Line-in			1.8	Vp-p	
Operating Temp. without TP		0	+60	°C	
Storage Temp. without TP		-20	+60	°C	
Operating Temp. with 5W RTP		0	+60	°C	
Storage Temp. with 5W RTP		-20	+60	°C	
Operating Temp. with PCAP		0	+50	°C	
Storage Temp. with PCAP		-20	+60	°C	
High Temperature & High Humidity (Non-condensing) without TP		-	+50 / 80	°C / %	
High Temperature & High Humidity (Non-condensing) with 5W RTP		-	+50 / 80	°C / %	
High Temperature & High Humidity (Non-condensing) with PCAP		-	+50 / 80	°C / %	

10. Recommended Operating Conditions

10.1 Electrical Characteristics

Parameter	Symbol	I/O	Min	Typ	Max	Unit	Note
Input Voltage	DC-in	I	+11	+12	+13	V	
Total Current	I-in	I	-	1060	-	mA	
Power Consumption		I	-	12.7	-	W	±15% @Without Headphone
Output Voltage	VDD	O	3.2	3.3	3.4	V	
Analog RGB Input Signal	Analog RGB in	RGB	I	0.7	-	Vp-p	@75Ω
DVI Input Signal					165	MHz	
HDMI Input Signal			-	-	165	MHz	



10.2 VGA Mode Characteristics

Dots per inch	H	Unit	Polarity	V	Unit	Polarity	Note
640 × 480	31.5	KHz	Positive	60	Hz	Negative	
800 × 600	37.7	KHz	Positive	60	Hz	Positive	
1024 × 768	48.2	KHz	Positive	59.8	Hz	Positive	
1366 × 768	47.6	KHz	Negative	59.6	Hz	Positive	
1280 × 1024	64.0	KHz	Positive	60	Hz	Positive	
1600 × 1200	74.9	KHz	Positive	59.9	Hz	Positive	
1920 × 1080	67.6	KHz	Positive	60	Hz	Positive	

11. Touch Panel Characteristics

11.1 5W Resistance Touch Panel Characteristics

-11.1.1 Electrical Performance

Parameter	Symbol	Min	Typ	Max	Unit	Note
Terminal Resistance	X	20		500	Ω	
	Y	20		500	Ω	
Linearity				1.5	%	
Insulation Impedance		20			MΩ	DC 25V
Response Time				10	ms	

-11.1.2 Optical Performance

Parameter	Specifications
Light Transmittance	78%
Haze	8%±2%

-11.1.3 Mechanical Performance

Parameter	Specifications
Input Method	Stylus or Finger
Operating Force	R0.8 Silicon Rubber, ≤250 gf
Surface Hardness	3H pencil

-11.1.4 Durability Performance

Parameter	Specifications
Knock Test	≥ 10,000,000 times

-11.1.5 Resistive Touch Panel Integration Design Guide

Avoid the design that Front-case overlap and press on the active area of the touch-panel.

Give enough gap (over 0.5mm at compressed) between the front case and touch-panel to protect wrong operating.

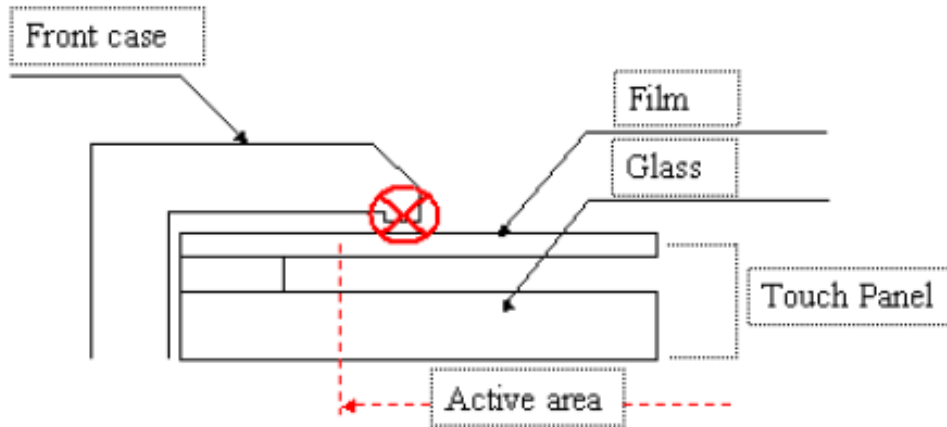

Use a buffer material (Gasket) between the touch-panel and front-case to protect damage and wrong operating.

Avoid the design that buffer material overlap and press on the inside of touch-panel viewing area.

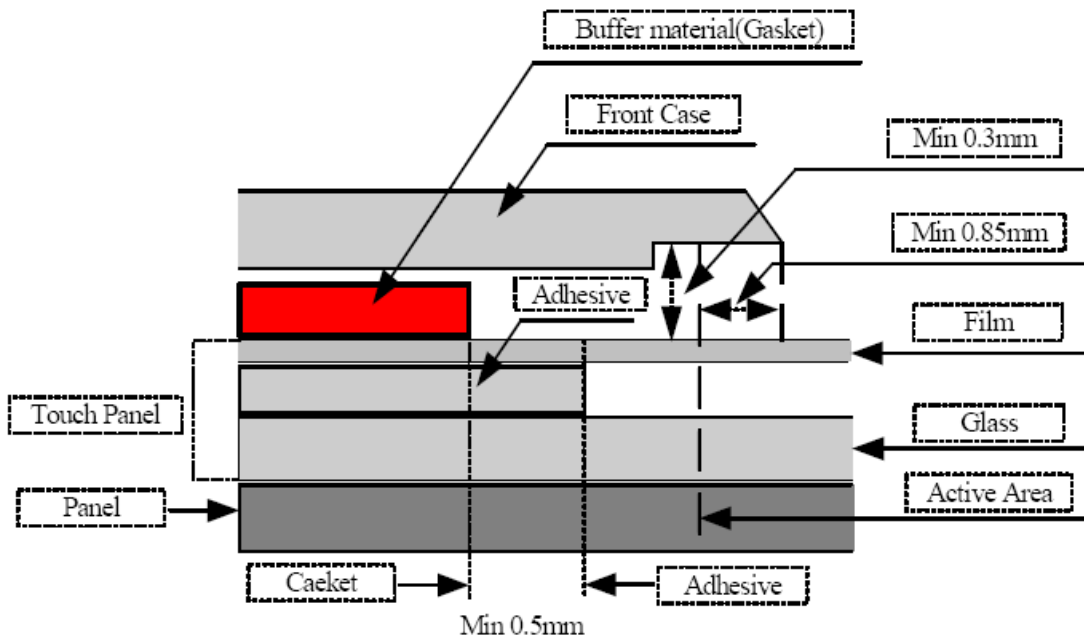

-11.1.6 Mechanical Design Notice For Resistive Touch Panel

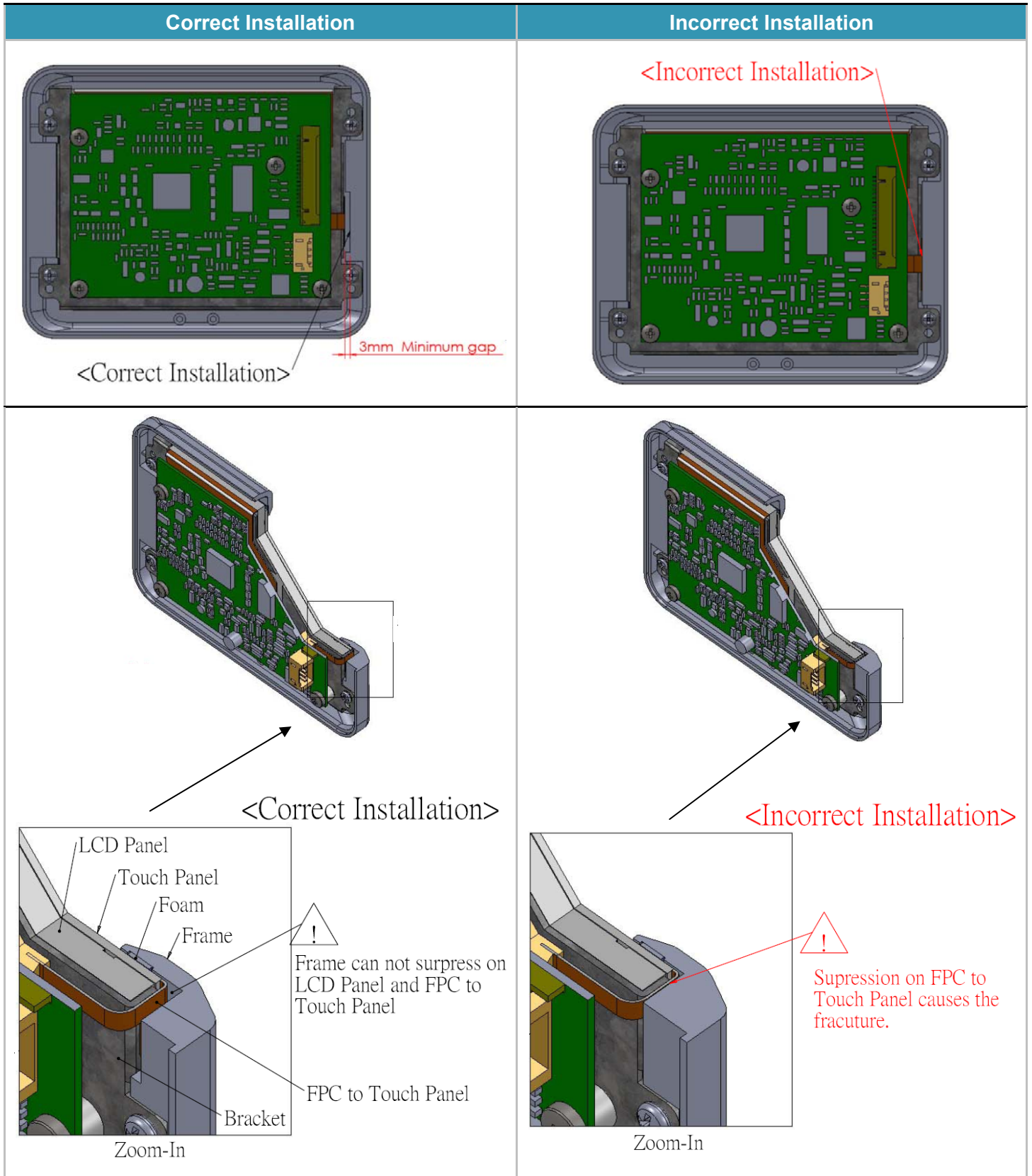



-11.1.7 Resistive Touch Panel Operation System Support

Driver Vender : EETI (eGalax_eMPIA Technology Inc.)

OS	Version	Interface
Windows	Windows 7, 8, 8.1, 10	USB/RS232
	Windows Embedded 7, 8	
	Windows Embedded POSReady 2009	
	Windows , XP, 2000	
	Windows XP Embedded	
Windows CE	Windows Embedded Compact 2013	USB/RS232
	Windows Embedded Compact 7	
	Windows CE 6.0	
	Windows CE.Net (4.x / 5.0)	
Linux	Kernel 2.6.24 Upward and 3.x.x (X86 / ARM / MIPS)	USB
	Kernel 2.6.23 Downward (X86)	
	Kernel 2.4.x (x86)	
Android	Android Version 2.3.x upwards (X86 / ARM / MIPS)	USB
Mac OS	Mac OS X 10.5.3 Leopard (Power PC)	USB
	Mac OS X 10.7.4 Earlier (32Bit) (Intel CPU)	
	Mac OS X 10.7.4 Earlier (64Bit) (Intel CPU)	
	Mac OS X 10.7.5 (32Bit) (Intel CPU)	
	Mac OS X 10.7.5 (64bit) (Intel CPU)	
	Mac OS X 10.8.x Mountain Lion (Intel CPU)	
	Mac OS X 10.9.x Mavericks (Intel CPU)	
	Mac OS X 10.10.x Yosemite (Intel CPU)	
QNX	QNX Neutrino RTOS V6.5/6.4	USB/RS232
	QNX Neutrino RTOS V6.3	

Note: 1. How to use Touch Driver, please refer to Readme of Touch Screen Driver CD Disk.

2. Please refer to the iTech website for the latest driver version and support operating system.

iTech website: <http://www.itechlcd.com>



11.2 Projected Capacitive Touch Panel Characteristics

-11.2.1 Electrical Performance

Parameter	Symbol	Min	Typ	Max	Unit	Note
Operating Voltage		-	-	5V		

-11.2.2 Optical Performance

Parameter	Specifications
Light Transmittance	≥ 80%

-11.2.3 Mechanical Performance

Parameter	Specifications
Input Method	Finger & Cap. Stylus
Touch Function	10 Points
Interface	USB
Surface Hardness	≥ 7H
Cover Spec.	Chemically strengthened T=1.8mm Black Printing
Knock Test	≥ 10,000,000 times

-11.2.4 Projected Capacitive Touch Panel Operation System Support

Driver Vender : WEIDA (WEIDA HI-TECH Co. Ltd.)

OS	Version	Interface
Linux	Ubuntu 10.10~17.10	USB
	Lubuntu 12.04~16.04	
	Fedora 14~25	
	RHEL 6.2~7.0	
	CentOS 6.2~7.0	
	openSUSE 12.1~42.3	
	SUSE 12	
Debian 6~9		
Android	Android 5	USB
Windows	Win 7 & Win8 & Win 10 built-in	USB

Note: 1. How to use Touch Driver, please refer to Readme of Touch Screen Driver CD Disk.

2. Please refer to the iTech website for the latest driver version and support operating system.

iTech website: <http://www.itechlcd.com>

12. Key Function by OSD

12.1 Menu Operation

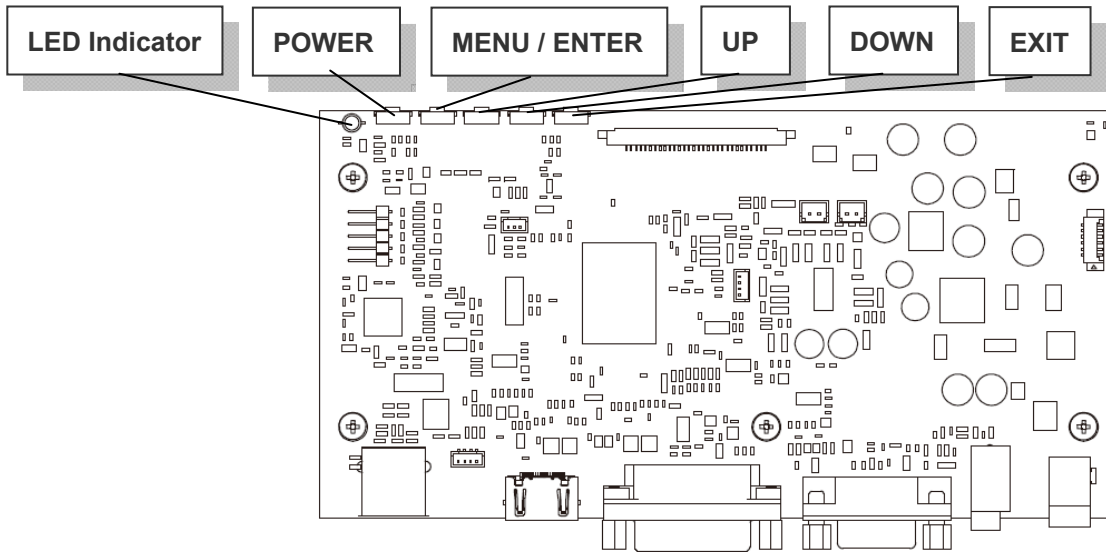

OSD ICON Instructions :

1. POWER : Power On/Off (※Press for 3 secs to turn off)
2. MENU / ENTER : (After turning on MENU, only ENTER is available)
3. UP : Move Upward / Increase Value / Option Switch
4. DOWN : Move Downward / Decrease Value / Option Switch
5. EXIT : Return to Previous Page
6. LED Indicator
 - Waiting : Flickering Green
 - Power ON : Green
 - Power OFF : Red

Save OSD Setting:



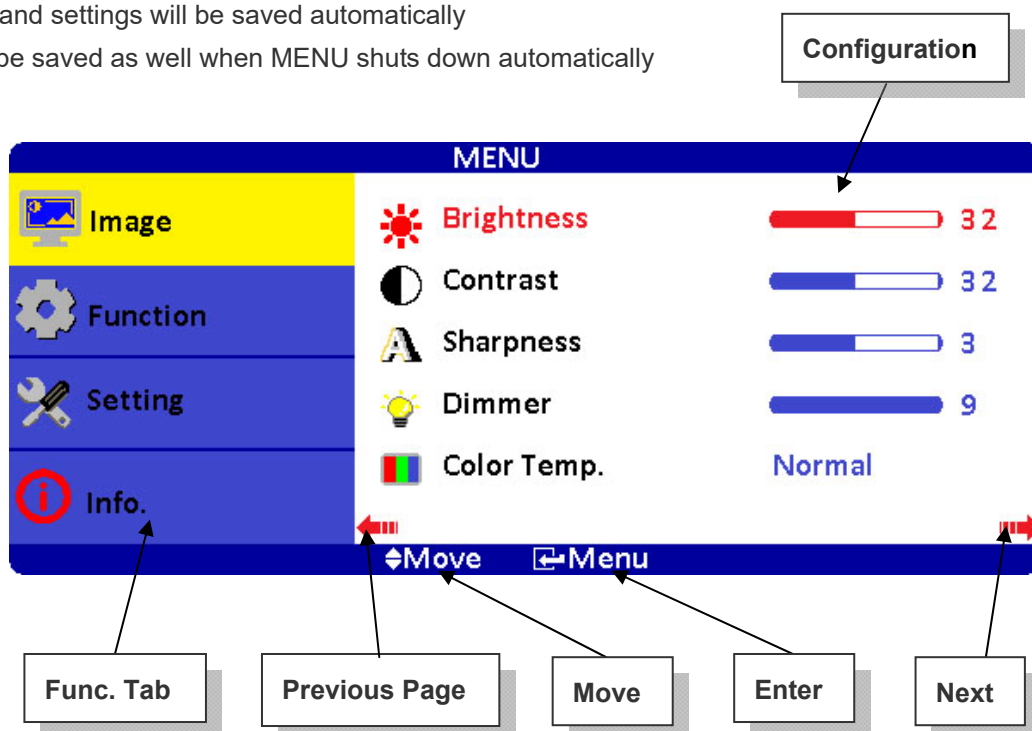







1. EXIT MENU and settings will be saved automatically
2. Settings will be saved as well when MENU shuts down automatically



Overview of the Menu :









Image

Indicator	Meaning	Default	Adjustable range	Remark
	Brightness	32	0~63	Adjust-Bar
	Contrast	32	0~63	Adjust-Bar
	Sharpness	3	1~5	Adjust-Bar
	Dimmer	15	0~15	Adjust-Bar
	Color Temp.	Normal	Normal / Warm / Cool	
	H-Position	0	-25~+25	VGA only
	V-Position	0	Normal :-25~+21 800*600:-25~+20	VGA only
	Clock	0	-25~+25	VGA only
	Phase	32	0~63	VGA only
	Auto	By different resolution		VGA only
	Exit			



Function

ICON	Meaning	Default	Adjustable range	Function	Remark
	Show Status	On	On / Off	Information of input source	ON: Show ; OFF: Hidden
	Blue Screen	On	On / Off	No signal input shows blue or black screen.	ON: Blue ; OFF: Black
	Auto Power On	On	On / Off	Modules turns on automatically without power key input.	ON: Auto ; OFF: Manual
	Detect Source	On	On / Off	Auto detect input source.	ON: Auto ; OFF: Normal
	Auto Power Saving	Off	6s / 15s / 30s / Off	Modules go ready when no input source is detected.	ON: Auto ; OFF: Normal
	Auto Sleep	Off	15M / 30M / 60M / Off	Modules go sleep when set timing is out.	ON: Auto ; OFF: Normal
	Exit				

Note : After configuration is set, **RESET** won't restore to default setting.



Setting

Indicator	Meaning	Default	Adjustable range	Remark
	Source	VGA	VGA / HDMI	
	Volume	32	0~63	
	Mute	Off	On / Off	On : Mute · Off : Sound
	Language	English	English / 中文 / 日本語 / 한국의 / Française / Deutsch / Italiano / Española / Português	
	Reset			Restore to default
	Exit			



Info.

MENU

Image	Source : VGA Resolution : 1280x800
Function	H-Position : 49.2KHz V-Position : 59.7Hz
Setting	Program Ver : 1.00 Command Ver : 1.00
Information	

↕ Move ↩ Exit / Menu

Hot Key When OSD Menu is Off :

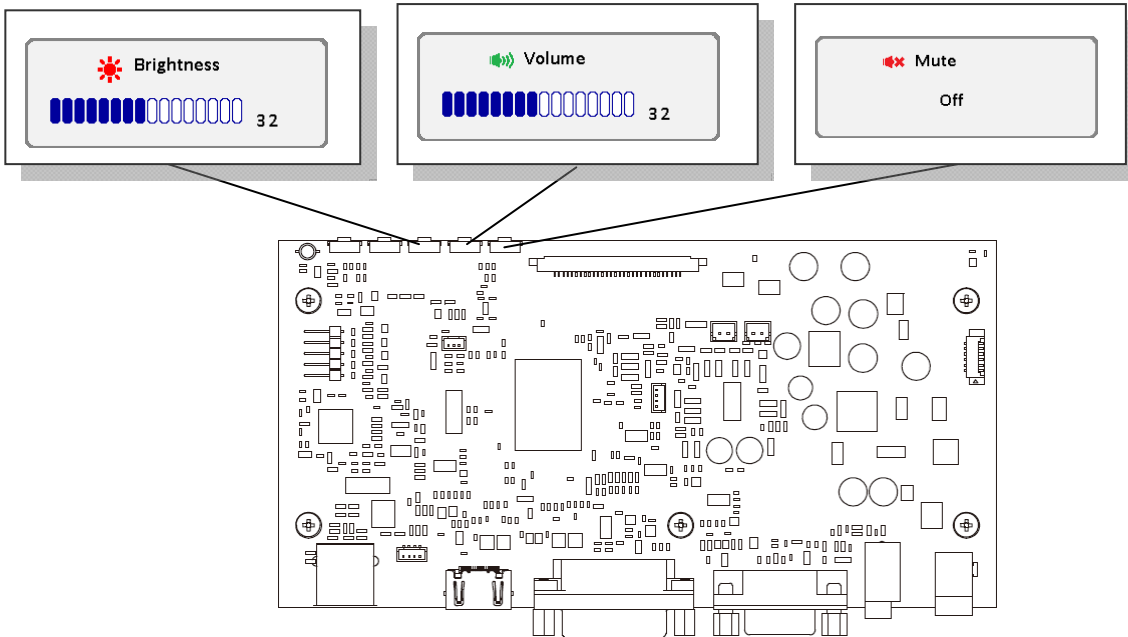

Information of Input Source and Functionality :

The screenshot shows a Windows desktop with the following information:

- Input Source:** VGA (1280x800)
- Resolution:** 1280x800
- Detect Source Warning:** A warning icon with the text "Detect Source 5" and "VGA 1".

Callouts from the warning icon indicate:

- Detect Source Remaining Secs:** 5
- VGA Mode Remaining Secs:** 1

[Source] : Input Signal Switch

Overview of Input Signals :

Indicator	Interface
	VGA
	DVI
	HDMI

13. Dimension Information

13.1 Unit (FCOPW1560-PCAP)

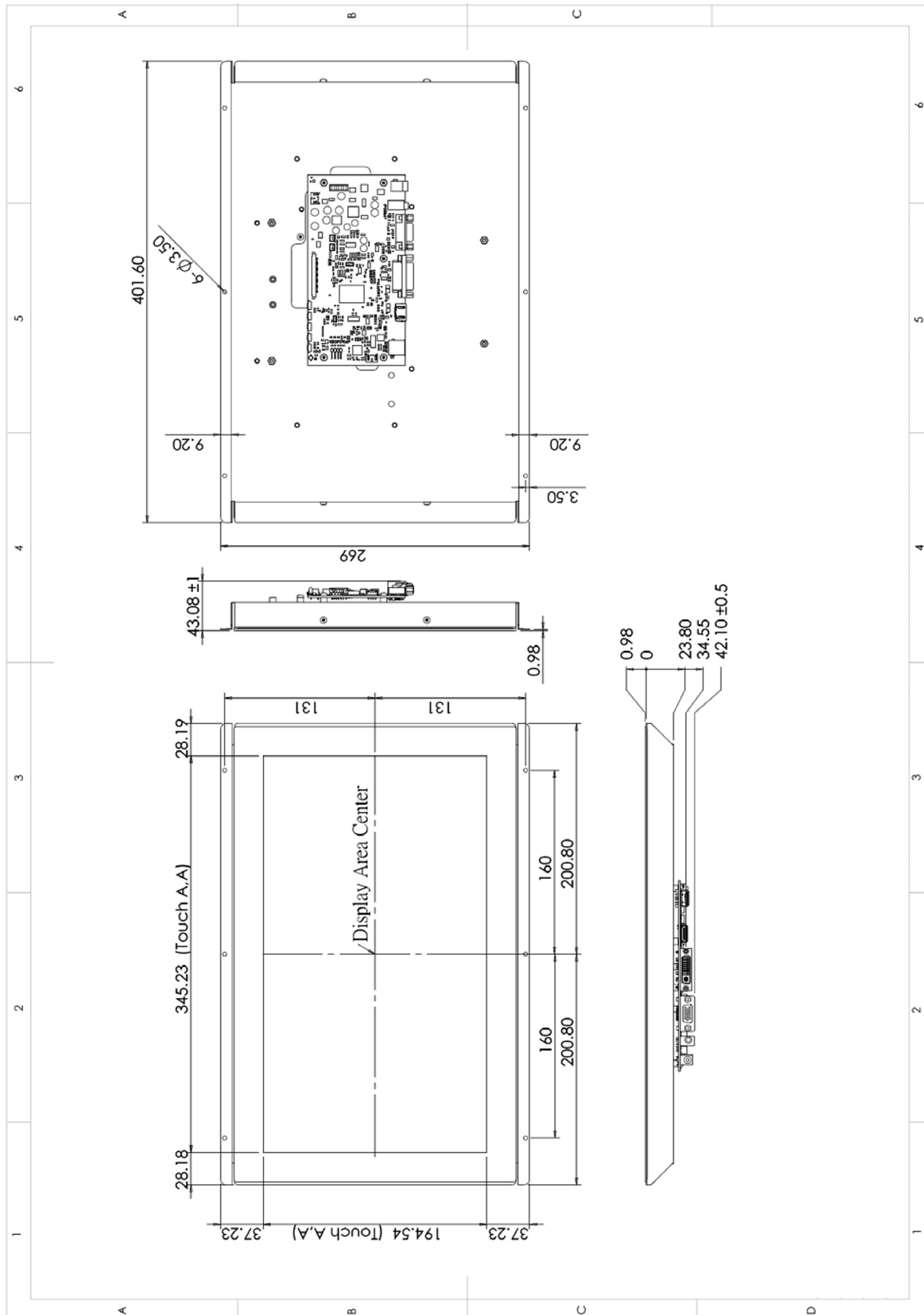



14. Appendix

14.1 TFT-LCD Mechanical Specifications

Parameter	Specifications	Unit
Screen Size	15.6 (diagonal)	Inch
Display Format	1366 x (R.G.B) x 768	Dot
Active Area	344.232(W) × 193.536(H)	mm
Pixel Pitch	0.252(H) x 0.252(V)	mm
Pixel Arrangement	RGB vertical stripe	
Surface Treatment	AG type, 3H hard coating	

14.2 TFT-LCD Optical Characteristics

Parameter	Symbol	Condition	Min	Typ	Max	Unit	Remark	
Viewing Angle	Horizontal	Left	---	80	---	deg		
		Right	---	80	---	deg		
	Vertical	Top	CR ≥ 10	---	80	---	deg	
		Bottom		---	80	---	deg	
Contrast Ratio	CR	At optimized Viewing angle	400	500	---	---		
Luminance	L		240	300	---	cd/m ²		
LED Life Time		25°C	50000	---	---	Hrs	Note	

Note: The "LED Life Time" is defined as the module brightness decrease to 50% original.