

SPECIFICATION APPROVAL SHEET

Full Flat Panel Design (Non IP Rated) 15" (1024x768) Digital TFT LCD, Aspect Ratio: 4:3, Input Signal VGA / DVI-D/ HDMI 1.3a, Maximum Support Resolution 1920x1080, Stereo Audio Amplifier, Output 2W@40 Speaker Audio Line-In, 5 Wires Resistive Touch Panel, 5 Key Buttons Control, 8 Language OSD Menu, LED Backlight, Single Operation Voltage +12V, No cables, no accessories, no Power adapter.

MODEL: FCPM1500-TR



i-Tech Company LLC

TOLL FREE: (888) 483-2418 • EMAIL: info@itechlcd.com • WEB: www.iTechLCD.com



1. General Description

1.1 Features

- Full Flat Panel Design
- 15" (1024x768) Digital TFT LCD
- Aspect Ratio: 4:3
- Input Signal VGA / DVI-D/ HDMI 1.3a
- Maximum Support Resolution 1920x1080
- Stereo Audio Amplifier, Output 2W@4Ω Speaker
- Audio Line-In
- 5 Wire Resistive Touch
- 5 Key Buttons Control
- 8 Language OSD Menu
- LED Backlight
- Single Operation Voltage +12V

1.2 Applications

- Industrial
- Medical Environment
- Instrument Display
- Kiosk
- Security
- Signage
- Office Electronics
- Home Application
- Educate Application

2. Contents

Contents	Page
1. General Description.....	1
1.1 Features	1
1.2 Applications	1
2.Contents.....	2-3
3 . Specifications.....	4
4. Block Diagram.....	4
5. Order Information.....	5
5.1 Unit	5
6. Accessories (Option).....	6
7. Pin Description.....	7-10
7.1 DC-In : Pin Assignment of Power Input (DC Jack Inside Diameter:2.1 ϕ Outside Diameter:5.5 ϕ Side Entry Type)	7
7.2 VGA : Pin Assignment of Analog RGB Input (D-Sub 15Pin)	7
7.3 DVI : Pin Assignment of DVI-D (24 Pin)	8
7.4 HDMI : Pin Assignment of HDMI-A Type Input (HDMI 1.3a -19Pin Female)	9
7.5 L : Pin Assignment of Speaker Left (Pitch 2.0mm 2Pin , Side Entry Type)	9
7.6 R : Pin Assignment of Speaker Right (Pitch 2.0mm 2Pin , Side Entry Type)	10
7.7 USB Port : Pin Assignment of Touch USB (USB A Type - Female 2.0mm, Side Entry Type)	10
7.8 Line-In : Pin Assignment of Line-In/Ear Phone (Option) (Outside Diameter:3.5 ϕ Side Entry Type)	10
8. Absolute Maximum Ratings.....	11
8.1 Absolute Maximum Ratings	11
9. Recommended Operating Conditions.....	11
9.1 Electrical Characteristics	11
9.2 VGA Mode Characteristics	11
10. 5 Wire Resistive Touch Panel Characteristics.....	12-13
10.1 Electrical Performance	12
10.2 Optical Performance	12
10.3 Mechanical Performance	12
10.4 Touch Panel Operation System Support	13
11. Installing the Monitor.....	14-15
11.1 Power cable connection	14
11.2 VGA signal cable connection	14
11.3 Switch on the power	14
11.4 Panel Mount Installation (Mount Clamp and Screw)	15
12. Key Function by OSD.....	16-19
12.1 Menu Operation	16-19
13. Dimension Information.....	20-21



13.1 Unit (FCPM1500-TR)	20
14. Appendix.....	21
14.1 TFT-LCD Mechanical Specifications	21
14.2 TFT-LCD Optical Characteristics	21

3. Specifications

LCD	
Panel Size	15"
Resolution (Pixels)	1024x768
Color	16.7M
Luminance without RTP	250 cd/m ²
Luminance (TR)	217 cd/m ²
Contrast Ratio	700
View Angle	80 / 80 / 70 / 70
LED Life Time	50K (Min)
Power Requirement	
Power Input (DC Jack 2.1 ϕ)	+12 VDC
Power Consumption@+12V	10.2 Watts (@Without Amplifier)
Touch Screen	
Resistive Touch	USB Interface
Resistive Touch Support OS	Windows / Linux

Input Signal		
VGA	D-Sub15	
DVI	DVI-D	
HDMI	1.3a	
Audio		
Amplifier	1W@8 Ω / 2W@4 Ω	
Line-In	Stereo Input Phone Jack ϕ 3.5	
Controls		
Key	5 Buttons	
Serial Remote Control	RS232 (Option)	
Mechanical		
Construction	Aluminum Front Bezel with Completely Covered Glass and SECC steel chassis	
Mounting Type	Panel / VESA 100 x 100 Mount	
Environment		
Temperature Range	Operating	-20 ~ +70 $^{\circ}$ C
	Storage	-20 ~ +70 $^{\circ}$ C
High Temperature & High Humidity (Non-condensing)	Operating	+40 $^{\circ}$ C / 90%

4. Block Diagram

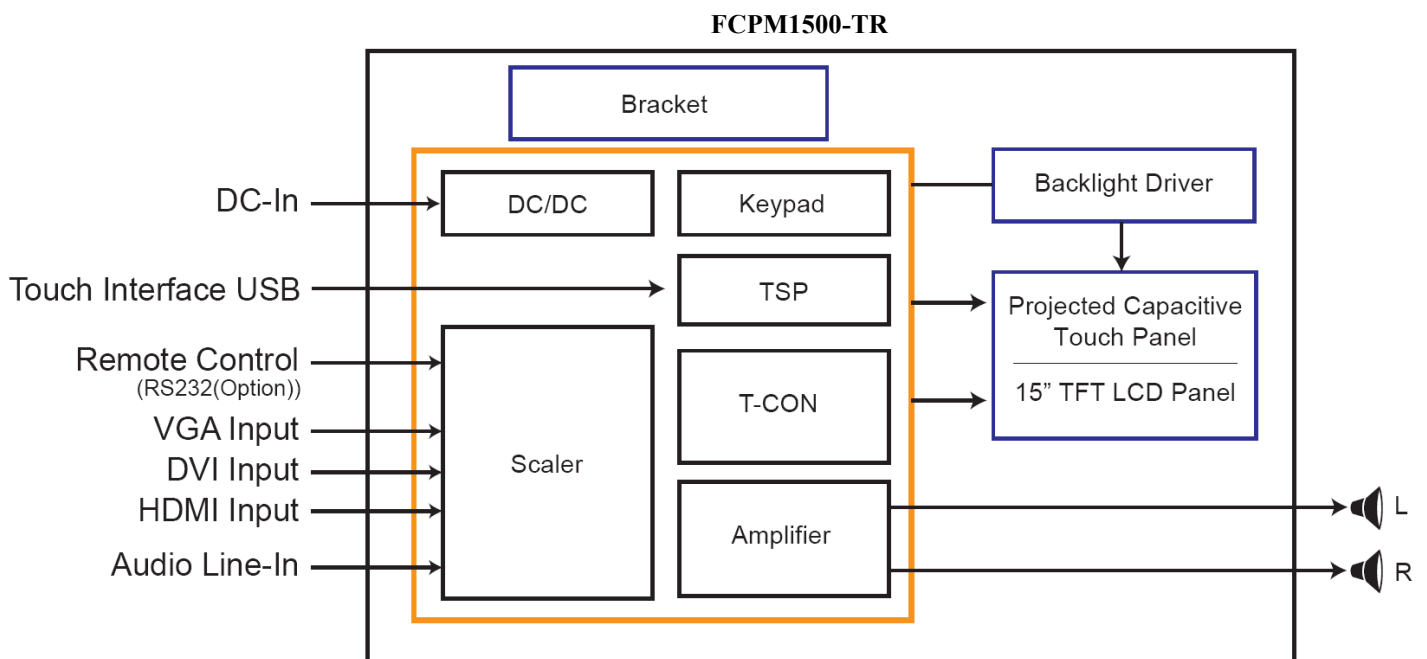



5. Order Information

5.1 Unit

Parameter	FCPM1500-TR		Unit	Remark
VGA	⊙			
DVI	⊙			
HDMI	⊙			
Touch Panel Type	Resistive Touch			
Touch Screen Interface	USB			
Audio Amplifier	⊙			
Audio Line-In	⊙			
5 Keys	⊙			
Waterproof	-			
Dimensions	369.69 x 284.15 x 47.3		mm	
Weight	3		Kg	±10%
Condition	Standard			

Note: 1. The assembling of panel and bracket is aimed for delivery, packaging and experiment. If the demand of shockproof and long-term fix, pls have it into consideration of mechanism design.

Parameter	Condition
Ear Phone	Non-standard
RS232 Remote Control	
Light Sensor	
Accessories (Option)	Standard

Note: Special order condition will apply to non-standard items and pls contact salespersons in iTech.

6. Accessories (Option)

Before you begin installing the Open Frame, please make sure that the following materials have been shipped:



A.



B.



C.



D.



E.



F.



G.



H.



I.

A. AC to DC Adapter (L:1500mm,100-240V_{AC} 50-60Hz to +12V_{DC} @ 3.3A, ϕ 2.1)

B. Power Cord (L:1800mm, Plug Type B for USA)

C. HDMI Cable (L:1800mm)

D. DVI Cable (L:1800mm)

E. VGA Cable (L:1800mm)

F. USB Cable (L:1800mm)

G. AUDIO Cable (L:1800mm)

H. Speaker (2.5W @ 4 Ω L:400mm *2 Pieces)

I. Mount Clamp and Screw *12 Pieces

7. Pin Description

7.1 DC-In : Pin Assignment of Power Input (DC Jack Inside Diameter:2.1 ϕ Outside Diameter:5.5 ϕ Side Entry Type)

Pin No.	Symbol	I/O	Description	Remark
1	DC-IN	I	+12Vdc Input Voltage	
2	GND	-	Power Ground	

7.2 VGA : Pin Assignment of Analog RGB Input (D-Sub 15Pin)

Pin No.	Symbol	I/O	Description	Remark
1	RI+	I	Analog Red Signal	
2	GI+	I	Analog Green Signal	
3	BI+	I	Analog Blue Signal	
4	GND	-	Ground	
5	VGA-Det	I	VGA Detect	
6	AGND	-	Analog Ground	
7	AGND	-	Analog Ground	
8	AGND	-	Analog Ground	
9	VGA5V	-	VGA +5V Input	
10	GND	-	Ground	
11	GND	-	Ground	
12	VGA_SDA	-	DDC2 Data	
13	HS_IN	I	TTL Horizontal sync.	
14	VS_IN	I	TTL Vertical sync.	
15	VGA_SCL	-	DDC2 Clock	

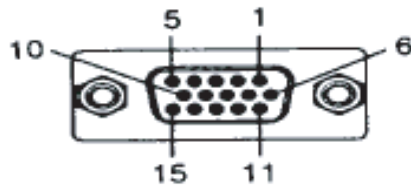

7.3 DVI : Pin Assignment of DVI-D (24 Pin)

Pin No.	Symbol	I/O	Description	Remark
1	DATA2-	I	Negative DVI Input for A Link Data Channel 2	
2	DATA2+	I	Positive DVI Input for A Link Data Channel 2	
3	GND	-	Ground	
4	NC	-	No Connection	
5	NC	-	No Connection	
6	DVI_SCL	I	DDC2 Clock	
7	DVI_SDA	I	DDC2 Data	
8	NC	-	No Connection	
9	DATA1-	I	Negative DVI Input for A Link Data Channel 1	
10	DATA1+	I	Positive DVI Input for A Link Data Channel 1	
11	GND	-	Ground	
12	NC	-	No Connection	
13	NC	-	No Connection	
14	DVI5V	I	DVI +5V Input	
15	DET_DVI	I	DVI Detect	
16	DVI_HPD	-	Hot Plug Detect	
17	DATA0-	I	Negative DVI Input for A Link Data Channel 0	
18	DATA0+	I	Positive DVI Input for A Link Data Channel 0	
19	GND	-	Ground	
20	NC	-	No Connection	
21	NC	-	No Connection	
22	GND	-	Ground	
23	DCLK+	I	Positive DVI Input for A Link Clock Channel	
24	DCLK-	I	Negative DVI Input for A Link Clock Channel	

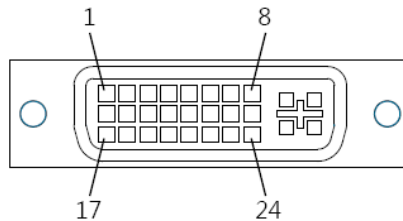

7.4 HDMI : Pin Assignment of HDMI-A Type Input (HDMI 1.3a -19Pin Female)

Pin No.	Symbol	I/O	Description	Remark
1	DATA2+	I	Positive HDMI Input for B Link Data Channel 2	
2	DET_HDMI	-	HDMI Detect	
3	DATA2-	I	Negative HDMI Input for B Link Data Channel 2	
4	DATA1+	I	Positive HDMI Input for B Link Data Channel 1	
5	GND	-	Ground	
6	DATA1-	I	Negative HDMI Input for B Link Data Channel 1	
7	DATA0+	I	Positive HDMI Input for B Link Data Channel 0	
8	GND	-	Ground	
9	DATA0-	I	Negative HDMI Input for B Link Data Channel 0	
10	DCLK+	I	Positive HDMI Input for B Link Clock Channel	
11	GND	-	Ground	
12	DCLK-	I	Negative HDMI Input for B Link Clock Channel	
13	NC	-	No Connection	
14	NC	-	No Connection	
15	HDMI_SCL	I	DDC2 Clock	
16	HDMI_SDA	I	DDC2 Data	
17	GND	I	DDC/CEC Ground	
18	HDMI5V	I	HDMI +5V Input	
19	HDMI_HPD	I	Hot Plug Detect	

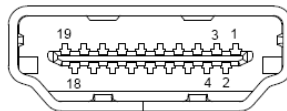

7.5 L : Pin Assignment of Speaker Left (Pitch 2.0mm 2Pin , Side Entry Type)

※ Connector Part No.: A2001WR2-2P(JWT) ;

※ Matching Connector Part No.: A2001H02-2P(JWT) .

Pin No.	Symbol	I/O	Description	Remark
1	+LOUT	O	Left Speaker Out+	
2	-LOUT	O	Left Speaker Out -	

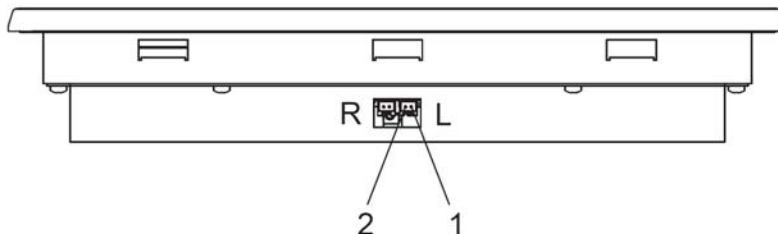

7.6 R : Pin Assignment of Speaker Right (Pitch 2.0mm 2Pin , Side Entry Type)

※ Connector Part No.: A2001WR2-2P(JWT) ;

※ Matching Connector Part No.: A2001H02-2P(JWT) .

Pin No.	Symbol	I/O	Description	Remark
1	+ROUT	O	Right Speaker Out+	
2	-ROUT	O	Right Speaker Out-	

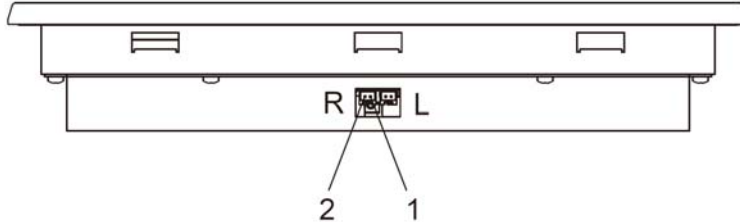

7.7 USB Port : Pin Assignment of Touch USB (USB A Type - Female 2.0mm, Side Entry Type)

Pin No.	Symbol	I/O	Description	Remark
1	VBUS	-	USB VCC	
2	D-	-	DATA (-)	
3	D+	-	DATA (+)	
4	DGND	-	Digital Ground	

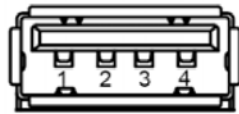

7.8 Line-In : Pin Assignment of Line-In/Ear Phone (Option) (Outside Diameter:3.5 φ Side Entry Type)

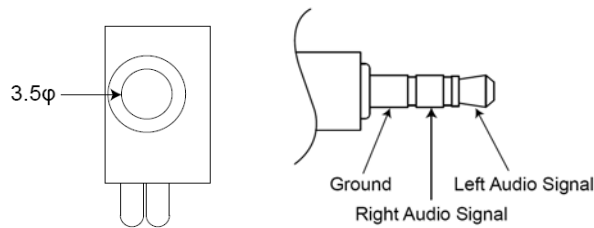



8. Absolute Maximum Ratings

8.1 Absolute Maximum Ratings

Parameter	Symbol	Min	Max	Unit	Remark
Input Voltage	V _{in}	11	13.5	V	
Analog RGB Input Signal	Analog RGB in	0.5	2.0	V _{p-p}	
Digital Input Signal	TTL	-0.3	3.6	V	
DVI Input Signal		-	165	MHz	
HDMI Input Signal		-	165	MHz	
Line-in			1.8	V _{p-p}	
Operating Temp.		-20	+70	°C	
Storage Temp.		-20	+70	°C	
High Temperature & High Humidity (Non-condensing)		-	+40°C / 90%	°C / %	

9. Recommended Operating Conditions

9.1 Electrical Characteristics

Parameter	Symbol	I/O	Min	Typ	Max	Unit	Note
Input Voltage	DC-in	I	11.5	12	13	V	
Total Current	I-in	I		850		ma	+12V
Power Consumption		I		10.2		w	±15% @Without Amplifier
Output Voltage	VDD	O	3.2	3.3	3.4	V	
Analog RGB Input Signal	Analog RGB in	RGB		0.7		V _{p-p}	@75Ω
DVI Input Signal					165	MHz	
HDMI Input Signal					165	MHz	

9.2 VGA Mode Characteristics

Dots per inch	H	Unit	Polarity	V	Unit	Polarity	Note
640 x 480	31.47	KHz	Positive	59.9	Hz	Positive	
800 x 600	37.88	KHz	Positive	60.3	Hz	Positive	
1024 x 768	48.36	KHz	Positive	60	Hz	Positive	
1280 x 1024	63.98	KHz	Positive	60	Hz	Positive	
1600 x 1200	75	KHz	Positive	60	Hz	Positive	
1920 x 1080	67.5	KHz	Positive	60	Hz	Positive	



10. 5 Wire Resistive Touch Panel Characteristics

10.1 Electrical Performance

Parameter	Symbol	Min	Typ	Max	Unit	Note
Input Voltage		-	-	5V		
Response Time		25	-	30	ms	

10.2 Optical Performance

Parameter	Specifications
Light Transmittance	≥ 87%

10.3 Mechanical Performance

Parameter	Specifications
Input Method	Stylus for Resistive or Finger Available
Touch Function	2 Points
Interface	USB
Surface Hardness	≥ 6H
Cover Spec.	Chemically strengthened T=1.8mm Black Printing
Knock Test	10,000,000 times above



10.4 Touch Panel Operation System Support

Driver Vender : EETI (eGalax_eMPIA Technology Inc.)

OS	Version	Interface
Windows	Windows XP Embedded	RS232/USB
	Windows Vista, XP, 2000	
	Windows Embedded POSReady 2009	
	Windows Embedded 7, 8	
	Windows 7, 8, 8.1, 10	
Windows CE	Windows CE.Net (4.x / 5.0)	RS232/USB
	Windows CE 6.0	
	Windows Embedded Compact 7	
	Windows Embedded Compact 2013	
Linux	Kernel 2.4.x (x86)	USB
	Kernel 2.6.23 Downward (X86)	
	Kernel 2.6.24 Upward and 3.x.x (X86 / ARM / MIPS)	
Android	Android Version 2.3.x upwards (X86 / ARM / MIPS)	USB
Mac OS	Mac OS X 10.5.3 Leopard (Power PC)	USB
	Mac OS X 10.7.4 Earlier (32Bit) (Intel CPU)	
	Mac OS X 10.7.4 Earlier (64Bit) (Intel CPU)	
	Mac OS X 10.7.5 (32Bit) (Intel CPU)	
	Mac OS X 10.7.5 (64bit) (Intel CPU)	
	Mac OS X 10.8.x Mountain Lion (Intel CPU)	
	Mac OS X 10.9.x Mavericks (Intel CPU)	
	Mac OS X 10.10.x Yosemite (Intel CPU)	
QNX	QNX RTOS V6.3	USB
	QNX Neutrino RTOS V6.5/6.4	
DOS	DOS	PS2

Note: How to use Touch Driver, please refer to Readme of Touchkit Disk.

11. Installing the Monitor

11.1 Power cable connection:

Connect the power cord to the AC outlet, and connect the power to the monitor through the AC/DC adapter.

11.2 VGA signal cable connection:

Plug one end of the 15-pin signal cable to the VGA connector at the rear of the PC system and the other end to the Open Frame monitor.

Secure the connectors with the screws on the cable connector at both ends.

11.3 Switch on the power:

Switch on the power switch on the rear cover of the Open Frame Monitor.

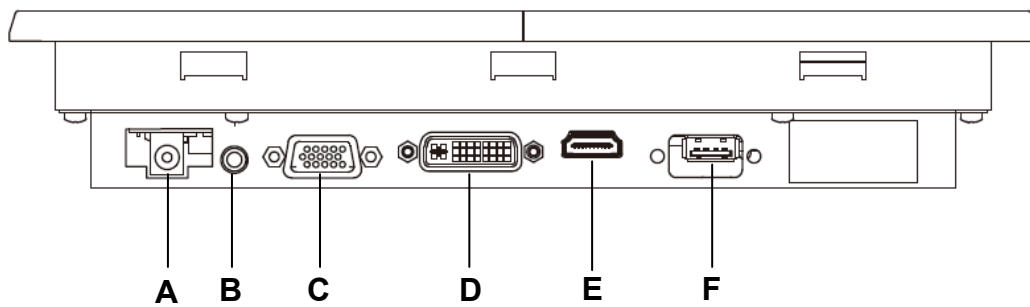

A. DC-In (+12V_{DC} The DC jack core is positive)

B. Line-In : Phone Jack ϕ 3.5

C. VGA D-sub 15 (Female)

D. DVI

E. HDMI

F. USB (For Touch Controller)

11.4 Panel Mount Installation (Mount Clamp and Screw):

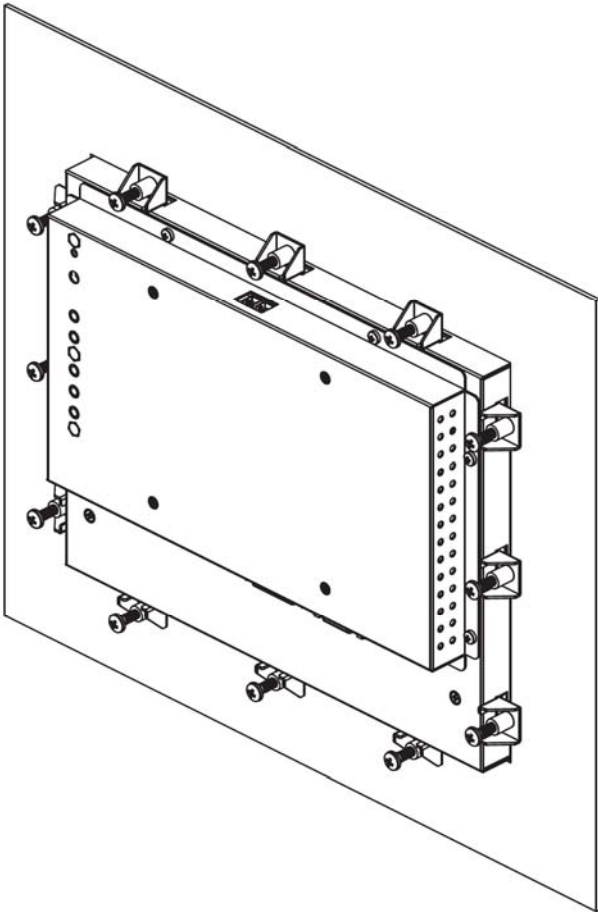

12. Key Function by OSD

12.1 Menu Operation

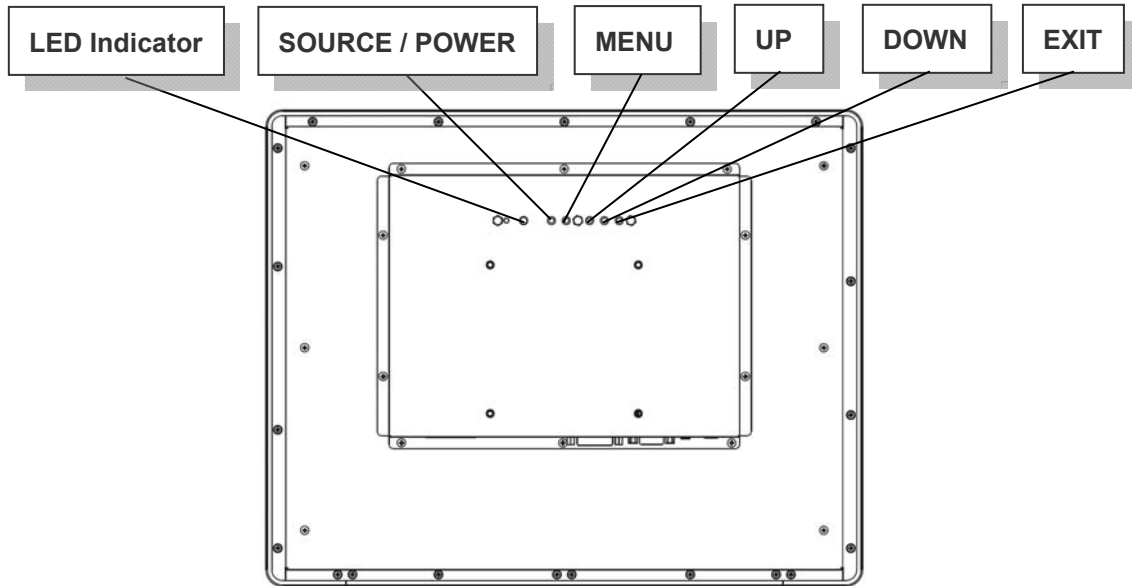

OSD ICON Instructions :

1. POWER : Power On/Off (※Press for 3 secs to turn off)
2. MENU / ENTER : (After turning on MENU, only ENTER is available)
3. UP : Move Upward / Increase Value / Option Switch
4. DOWN : Move Downward / Decrease Value / Option Switch
5. EXIT : Return to Previous Page
6. LED Indicator
 - Waiting : Flickering Green
 - Power ON : Green
 - Power OFF : Red

Save OSD Setting:



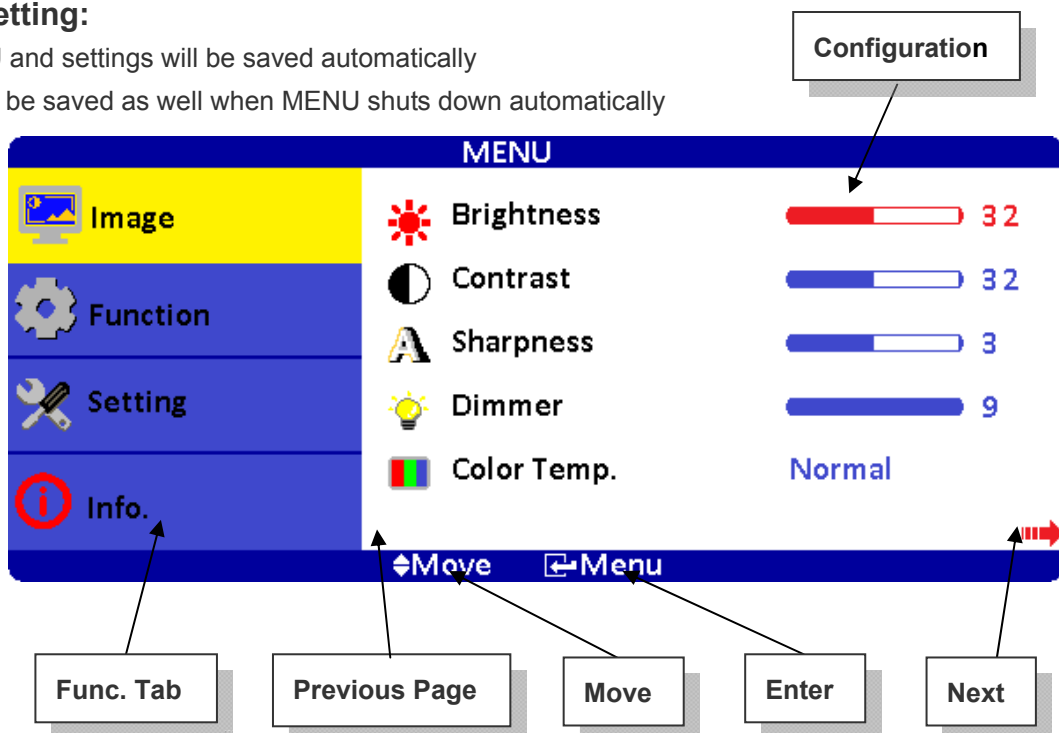







1. EXIT MENU and settings will be saved automatically
2. Settings will be saved as well when MENU shuts down automatically



Overview of the Menu :









Image

Indicator	Meaning	Default	Adjustable range	Remark
	Brightness	32	0~63	Adjust-Bar
	Contrast	32	0~63	Adjust-Bar
	Sharpness	3	1~5	Adjust-Bar
	Dimmer	15	0~15	Adjust-Bar
	Color Temp.	Normal	Normal / Warm / Cool	
	H-Position	0	-25~+25	VGA only
	V-Position	0	-25~+25	VGA only
	Clock	0	-25~+25	VGA only
	Phase	32	0~63	VGA only
	Auto	By different resolution		VGA only
	Exit			



Function

ICON	Meaning	Default	Adjustable range	Function	Remark
	Show Status	On	On / Off	Information of input source	ON: Show ; OFF: Hidden
	Blue Screen	On	On / Off	No signal input shows blue or black screen.	ON: Blue ; OFF: Black
	Auto Power On	On	On / Off	Modules turns on automatically Without power key input.	ON: Auto ; OFF: Manual
	Detect Source	On	On / Off	Auto detect input source.	ON: Auto ; OFF: Normal
	Auto Power Saving	Off	6s / 15s / 30s / Off	Modules go ready when no input source is detected.	ON: Auto ; OFF: Normal
	Auto Sleep	Off	15M / 30M / 60M / Off	Modules go sleep when set timing is out.	ON: Auto ; OFF: Normal
	Exit				

Note : After configuration is set, RESET won't restore to default setting.



Setting

Indicator	Meaning	Default	Adjustable range	Remark
	Source	VGA	VGA / DVI / HDMI	Reset won't restore to default setting
	Volume	32	0~63	
	Mute	Off	On / Off	On : Mute · Off : Sound
	Language	English	English / 中文 / 日本語 / 한국의 / Française / Deutsch / Italiano / Española / Português	Reset won't restore to default setting
	Reset			Restore to default
	Exit			



Info.

MENU

Image

Source : VGA

Function

Resolution : 1024x768

Setting

H-Position : 48.2KHz

V-Position : 59.8Hz

Information

Program Ver : 1.00

Command Ver : 1.00

◀ Move ▶ Exit / Menu



HOT KEY When OSD Menu is Off :

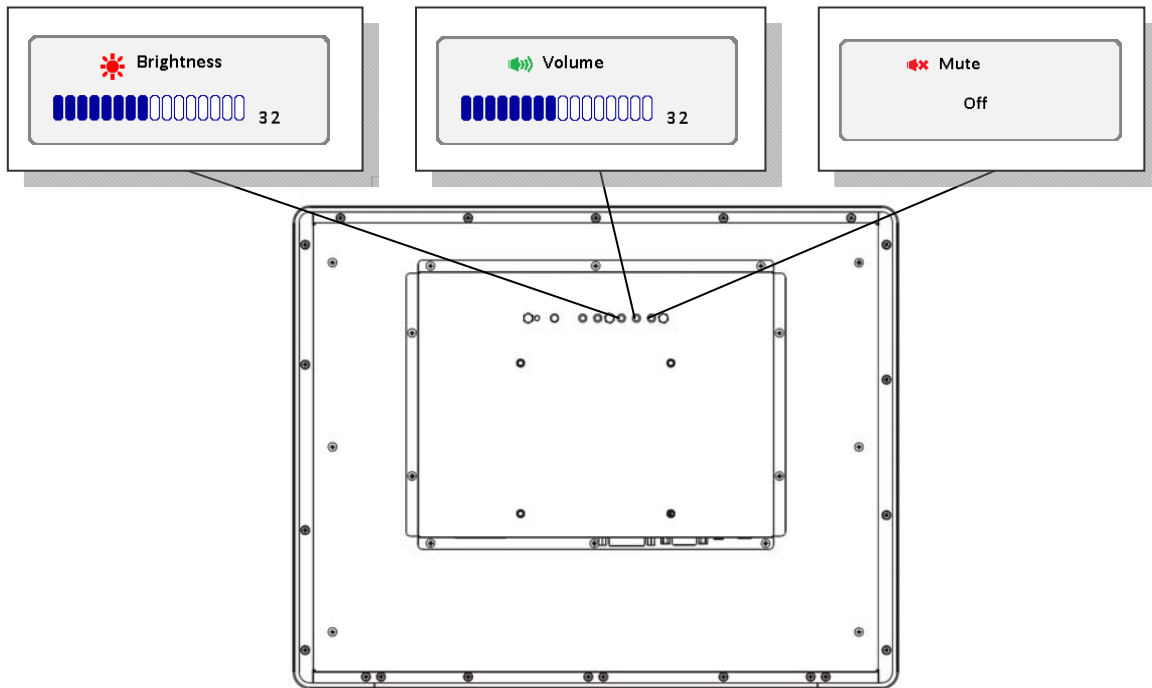

Information of Input Source and Functionality :

The screenshot shows a Windows desktop with the following elements:

- Input Source:** A box labeled 'Input Source' points to the 'VGA 1024x768' display icon in the system tray.
- Resolution:** A box labeled 'Resolution' points to the '1024x768' part of the display icon.
- Detect Source:** A system tray icon shows 'Detect Source 5' (with a red lightbulb icon) and 'VGA 1' (with a green lightbulb icon).
 - A box labeled 'Detect Source Remaining Secs' points to the '5'.
 - A box labeled 'VGA Mode Remaining Secs' points to the '1'.

[Source] : Input Signal Switch

Overview of Input Signals :

Indicator	Interface
	VGA
	DVI
	HDMI

13. Dimension Information

13.1 Unit (FCPM1500-TR)

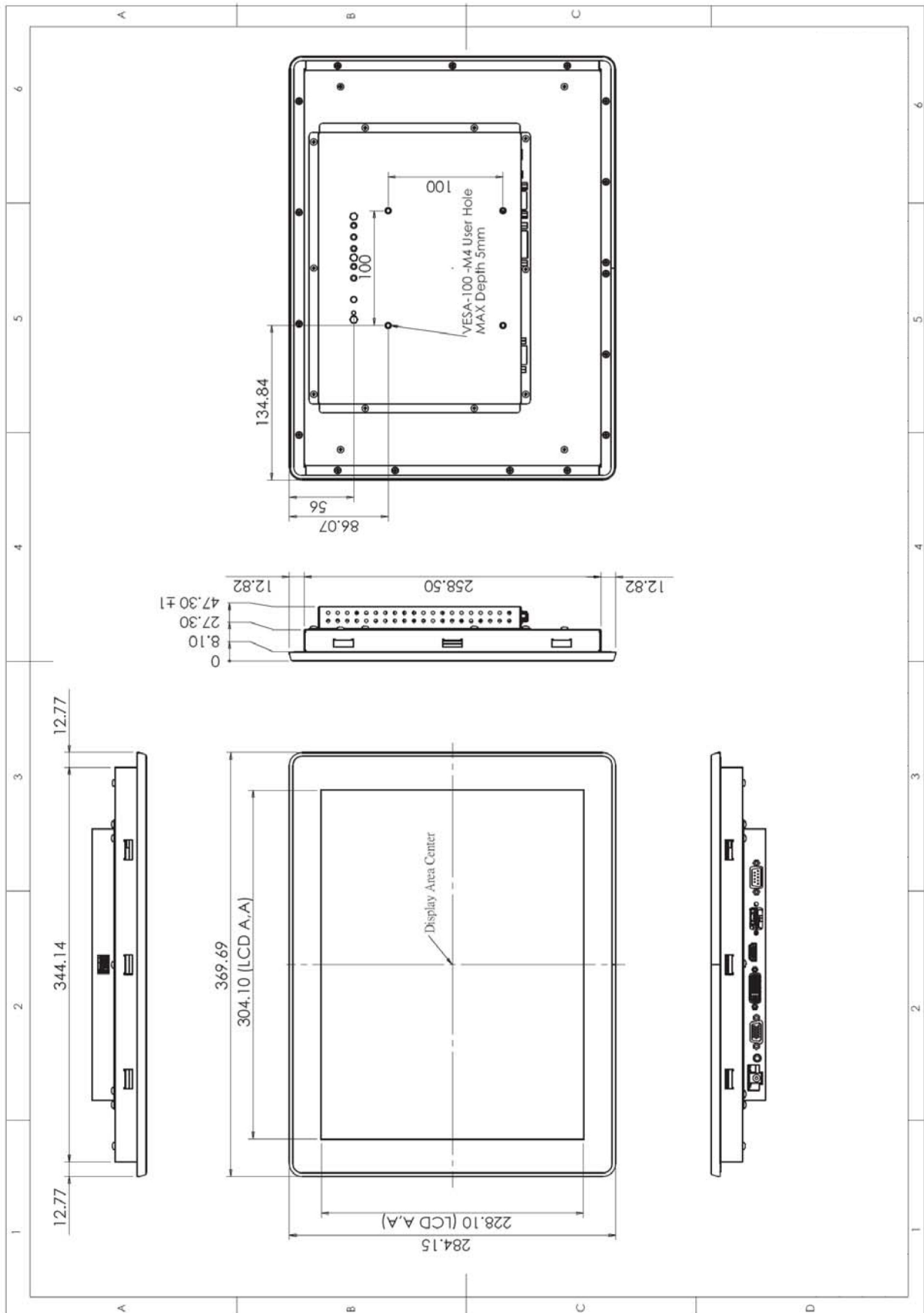



14. Appendix

14.1 TFT-LCD Mechanical Specifications

Parameter	Specifications	Unit
Screen Size	15 (diagonal)	Inch
Display Format	1024 x (R.G.B) x 768	Dot
Active Area	304.1(H) x 228.1(V)	mm
Pixel Pitch	0.297(H) x 0.297(V)	mm
Pixel Arrangement	RGB vertical stripe	
Surface Treatment	Anti-Glare, Haze=25%, Hard Coating (3H)	

14.2 TFT-LCD Optical Characteristics

Parameter	Symbol	Condition	Min	Typ	Max	Unit	Remark
Viewing Angle	Horizontal	Left	70	80	---	deg	
		Right	70	80	---	deg	
	Vertical	Top	50	70	---	deg	
		Bottom	50	70	---	deg	
Contrast Ratio	CR	At optimized Viewing angle	450	700	---	---	
Luminance without TR	L		200	250	---	cd/m ²	
LED Life Time		25°C	50000	---	---	Hrs	Note

Note: The "LED Life Time" is defined as the module brightness decrease to 50% original.