

## 19.5" Panel Mount Industrial Monitor

NEMA4 19.5" Panel Mount LCD Monitor (Stainless Steel Bezel) with tempered safety glass window HD-1080p (1920 x 1080, 16:9 aspect ratio). 250 nits (cd/m2) max, Video Input HD-15, DVI-D + DC Power Models – 9.6 to 36.6 VDC, 2.5 to 0.65 A, Class 2 or SELV/LPS,

*Rated for Hazardous Locations (optional) - UL Listed for Class I, Division 2 for Groups A, B, C, D; Class II, Division 2 for Groups F, G; Class III; Temp Code T4A (File No. E328481) per ANSI/ISA 12.12.01-2013.*



## Model: HPMW1950SG-C1D2-DC

Designed to provide the industrial user with excellent picture quality and rugged design for reliable continuous operation.

A unique single-cutout, stud-free design and depths of only 1.82" to 2.12" make them a snap to install. Options like touch screens and KVM Extenders make these displays highly versatile.

### FEATURES

- NEMA 4/12 or NEMA 4/4X/12, sealed to IP65/66 standards
- UL Rated for Hazardous Locations: Class I, II, III, Division 2
- High resolution and contrast
- Field-proven MTBF of more than 250,000 hours
- Touch Screen, Tempered Glass, and Acrylic Window options
- Only 1.82" to 2.12" deep
- Black carbon steel and stainless steel bezel options
- Panel mount without drilling stud holes
- 5 ft. cables included (optional to 1000 ft.)
- Industrial Certifications: UL 508A, UL 50E, FCC Class A, CE, UL 60950 3rd Edition / cUL Recognized Component

### OPTIONAL ACCESSORIES

- Industrial Panel Mount Keyboards (NEMA 4X rated)
- Screen Protectors (all sizes)
- Extended cable options up to 1000'
- KVM Extenders



RoHS

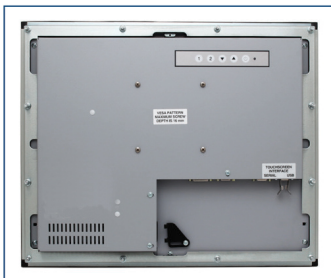

Rear view of 19" Panel Mount Monitor.



Panel Mount workstation configuration with monitor and industrial keyboard.



Optional KVM Extender allows monitor to be placed up to 1000' away from computer.



Optional Screen Protector guards touch screens from scratches and wear.

## SPECIFICATIONS

Display	
Type	Thin-film transistor (TFT) Active Matrix Liquid Crystal, LED Backlit
Size	19.5" diagonal / 16:9
Image Size (W x H)	435 x 239 mm (17.1" x 9.4")
Native Resolution*	HD1080p (1920 x 1080 @ 60 Hz)
Pixel Pitch	0.2265 mm x 0.221 mm
Number of Colors	16.7 million
Brightness (white)	250 nits (cd/m2)
Viewing Angle (Hori/Vert)	178° / 178°
Contrast Ratio	3000:1
Backlight Brightness half-life	50,000 hours
Video	
<b>Input Connectors</b>	HD-15, DVI-I
Inputs using Adapter**	HDMI, DisplayPort, or BNC
Input Signal Formats***	RGB Analog video, Separate H/V sync, Composite sync, Sync on Green; DVI
Horizontal / Vertical Scan	24-82 kHz / 50-75 Hz
Response Rate	20 ms
Environmental	
Temperature	Operating: 0° to 50°C (32° to 122°F); Storage: -20° to 60°C (-4° to 140°F)
Humidity	20% to 90% non-condensing
Operating Shock / Vibration	15 g, 6 msec, half-sine / Operating (sine): 1.0 g, swept sine 9-500 Hz; Transport (random): 0.1g2 /Hz, 10-200Hz; 0.03g2 /Hz, 200-2000 Hz
Altitude	Operating: up to 10,000 ft; Non-operating: up to 40,000 ft
Electrical	
Monitor Input	100 to 240 VAC, 1.5/0.75 A, 60/50 Hz or 9.6 to 36.6 VDC, 2.5 to 0.65 A
Power Consumption	~20 W
Physical	
Enclosure Type	Panel mount; rear collar compresses gasket against panel (5/16" maximum panel thickness); held by M5 studs
Panel Rating (with proper installation)	Black powder-coated carbon steel: NEMA/UL Type 12/4; built to IP65/IP66 standards Stainless steel: NEMA/UL Type 12/4/4X; built to IP65/IP66 standards
Depth behind Panel	50.0 mm (1.97")
Front Bezel Outside Dimensions (WxHxD)	527mm x 330mm x 7mm (20.75"x13.0"x0.28")
Cutout Dimensions (WxH)	497.8 mm x 298.5 mm (19.60" x 11.75")
Net / Shipping Weight	15 lbs. / 20 lbs
Window Options	Analog Resistive Touch Screen, Tempered Glass, or Acrylic Protective window options. Touch Screen option is a 5-wire resistive system, emulates a mouse, and uses Serial RS-232 or USB interface to host computer. Glass- armored touch screen including sulfur gas protection also available (call for details).
Compliances and Certifications	
Electrical	UL/EN/IEC62368-1, UL/EN/IEC60950-1, UL Recognized Component for US and Canada, UL 508A, CAN ICES-3A/NMB-3A, CE, FCC Class A, NOM
Enclosure, Environmental	UL 50E, IEC 60721-3 (Reliability), WEEE (Registration No. WEE/DJ1859ZX for UK only)
Hazardous Location	UL Listed for Class I, II, III, Div. 2, Groups A, B, C, D, F, G; T-Code T4A

\*Specifications subject to change without notice, not responsible for typographical errors.

# MECHANICAL DRAWINGS

This is subject to change without Notice. Final Drawings Will be Provided for Approval after Order.

Front View

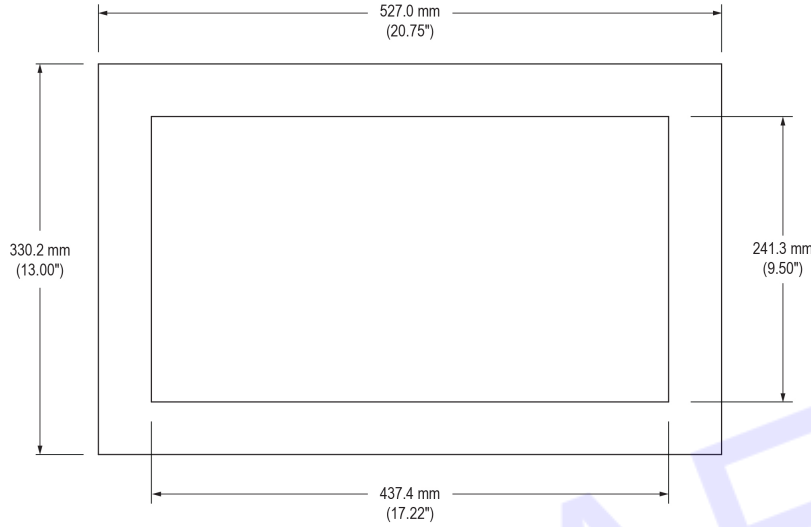

Side View

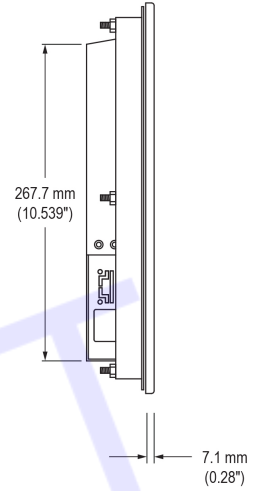

Rear View (showing Cutout Dimensions)

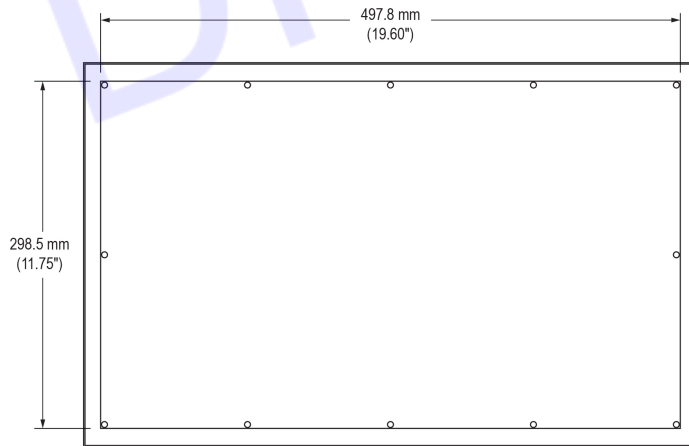

Bottom View

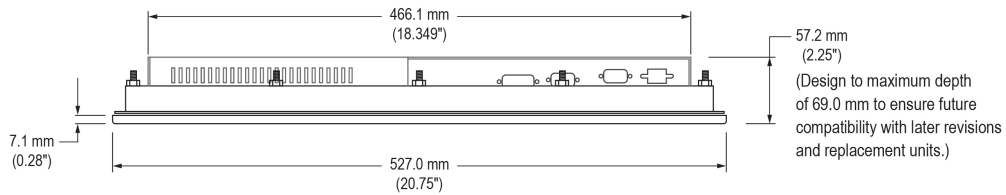

Cable Connections

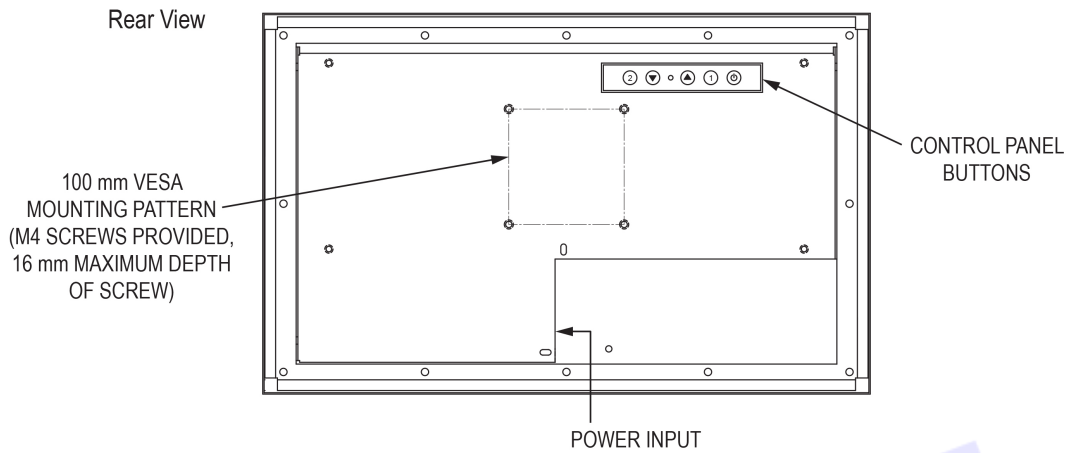

Bottom View

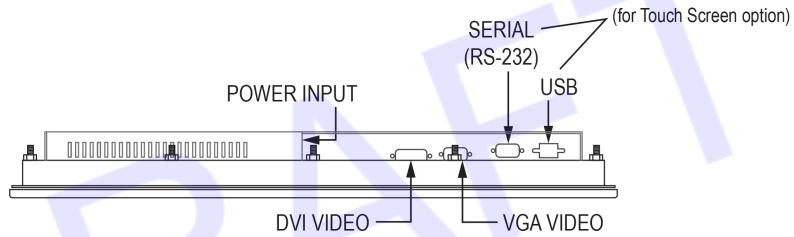

VB-20A Accessory Mounting Bracket

Rear View

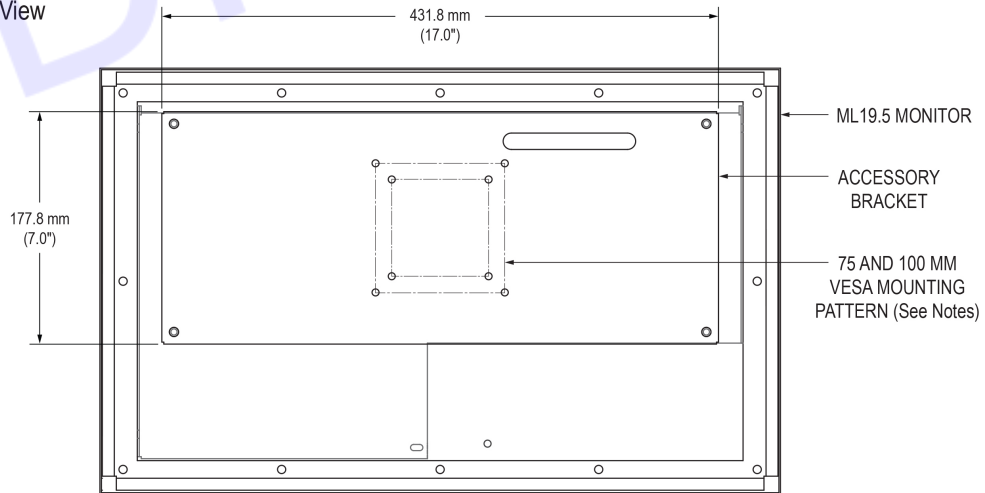

Bottom View

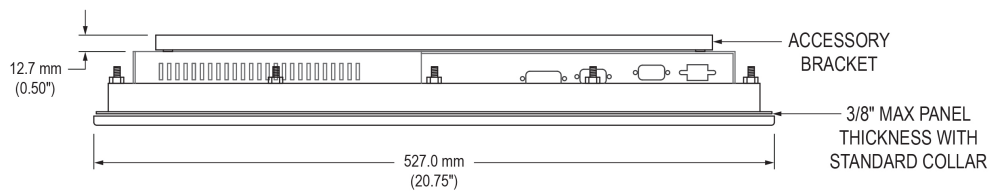

Drawing No.: HPMW1950SG-C1D2-D-03042023-V1