

Assembly Instructions

Rack Screws

Part Numbers:

10-32 - 0100-1-001-01, 0100-1-002-01, 0100-3-200-01, 0100-3-100-01

M5 - 0100-1-001-02, 0100-1-002-02, 0100-3-200-02, 0100-3-100-02

12-24 - 0100-1-001-03, 0100-1-002-03, 0100-3-200-03, 0100-3-100-03

M6 - 0100-1-001-04, 0100-1-002-04, 0100-3-200-04, 0100-3-100-04

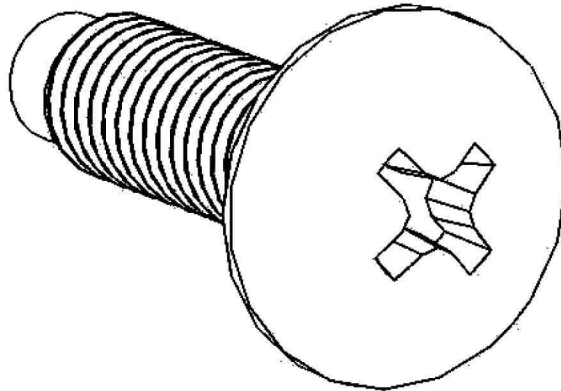

Tools Needed:

Screw Driver

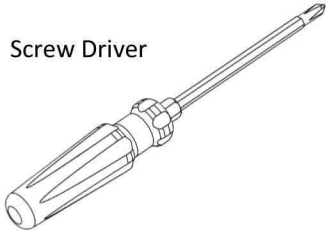

You may also need:

Cage Nuts



What's in the box?

Rack Screws

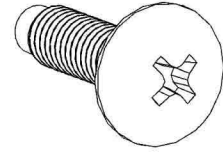

Cage Nut Style Rail

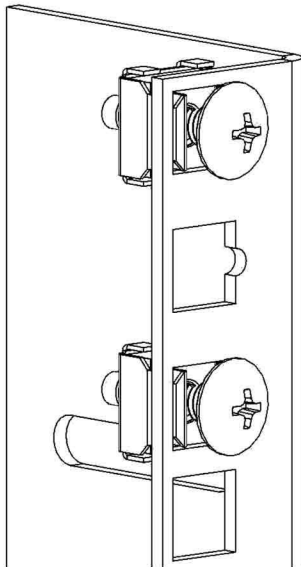
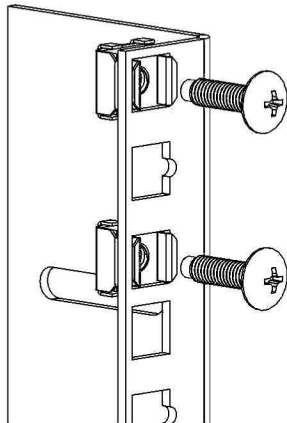

Tapped Rail

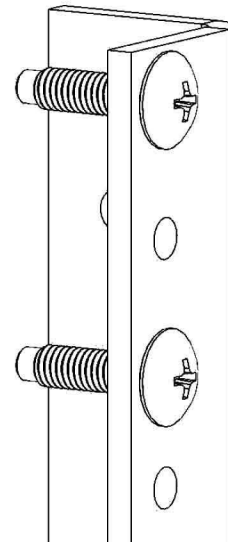
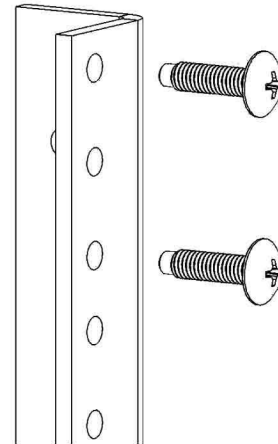

Distributed by : i-Tech Company LLC

TOLL FREE: (888) 483-2418 • EMAIL: info@iTechLCD.com • WEB: www.iTechLCD.com