

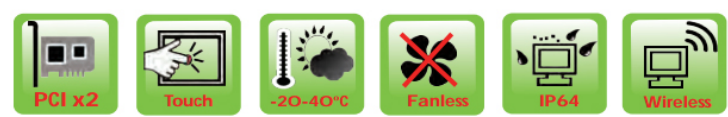

MPC1700CD / MPC1700CD-PCI 17" Industrial Fanless Touchscreen Panel PC Intel Atom D2550 dual core @1.86GHz CPU



- 17" (4:3) LED backlight Fanless Industrial Panel PC
- Intel Atom D2550 dual core @1.86GHz CPU
- One 1066/800MHz DDR3 SO-DIMM slot , max. 4G
- 5-wire resistive type touch screen supported
- 1*SATA for 2.5"HDD , 1* mSATA for SSD
- 4COM + 6USB + 1*VGA + 2*Giga LAN
- WIFI 802.11 b/g/n (option)
- 2 x PCI slot extension for short card ,1 x mPCIe space
- 2x Internal USB2.0 for Keypro
- OS support: Win7, Win XP(e), Win CE, Linux



Specification

	Model	MPC1700CD	MPC1700CD-PCI	
LCD Specifications	Size	17" w/o PCI	17" with 2 PCI slot extension	
	Resolution	1280 (W) x 800 (H)		
	Brightness (cd/m2)	500 cd/m2		
	Contrast Ratio	700:1		
	LCD color	262K / 16.2M		
	Pixel Pitch (mm)	0.240(H) x 0.240(V)		
	Viewing Angle (H-V)	160° (H) / 140° (V)		
	Backlight MTBF	30000 hrs (LED backlight)		
Touch	Touch Screen	5-wire resistive type with USB Interface		
	Touch Controller	EETI Touch kit		
System	CPU	Intel® Atom™ D2550 dual core 1.86 GHz CPU		
	Chipset	Intel® NM10		
	RAM	Support one 1066/800 MHz 204-pin DDR3 SO-DIMM slot (max. 4GB)		
	Ethernet	2*Realtek RTL8111E PCIe GbE controller supporting ASF 2.0		
	Audio Codec	Realtek ALC662 HD audio codec		
	SSD	mSATA		
	Input / Output	6 x RS-232 COM Port (DB-9) 2 x GbE LAN (RJ-45) 6 x USB2.0 1 x Audio jack 1 x MIC jack 1 x VGA	1 x Power On button 1 x DC input jack 1 x DC input bypass terminal (Option) 2 x internal USB2.0 for Keypro	
	Expansion Interface	No PCI slot	2 x PCI slot extension for PCI short card size, 1 x mPCIe	
System Cooling	Fanless			
Connectivity	Wireless	IEEE 802, 11b/g/n(Option)		
	Bluetooth	Optional		
Physical	Construction Front Panel	Steel front frame and whole case		
	Mounting	Panel,Stand, and VESA 100mm x 100mm, 75mmx75mm		
	Color	Black		
	Dimensions (WxHxD)mm	358 x 280 x 128.8	358 x 280 x 87.8	
	Weight (N/G)	4.6 kg	4.9kg	

1
Industrial Box PC Solution

2
Touch Panel PC Solution

3
USB touch monitor Solution

4
Panel PC Kits Solution

Environment	Operating Temperature (C)	-20°C ~ 40°C
	Storage Temperature (C)	-20°C ~ 60°C
	Humidity	10% to 95% (non-condensing)
Power	Power Supply	60W power adapter Input: 90VAC~264VAC, 50/60 Hz, Output: 12VDC
	Power Requirement	12 VDC
	Power Consumption	12V@2.5A(Intel® Atom™ D2550 CPU with 2GB DDR3 Momery)
Certification	IP Level	Front Panel IP 64
	Safety & EMC	CE / FCC

MPC1700CD (Standard)



MPC1700CD-PCI (2xPCI Slot)



Mechanical Drawing

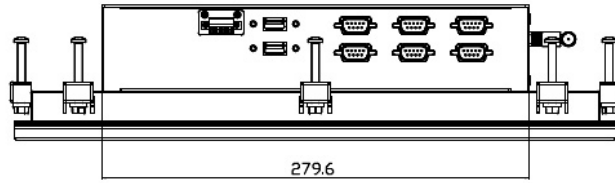

MPC1700CD Drawing

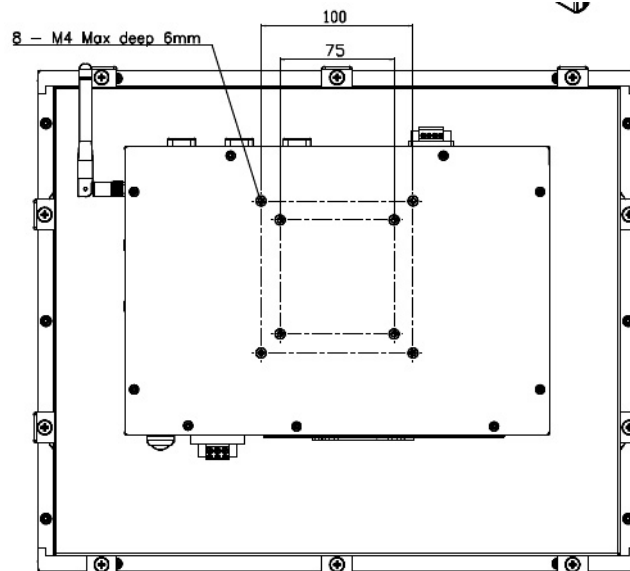
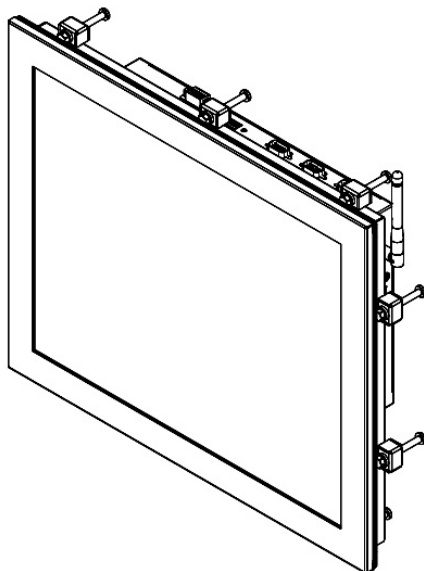
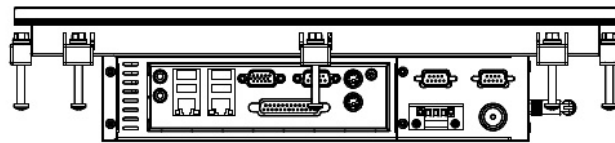
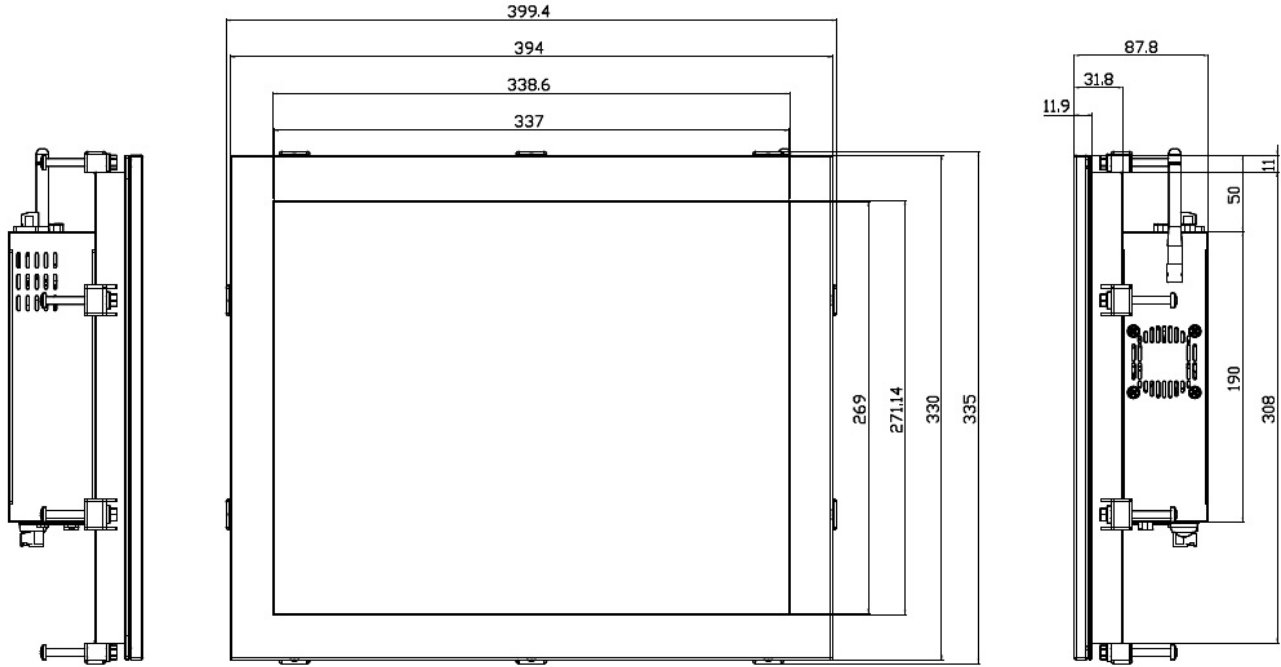

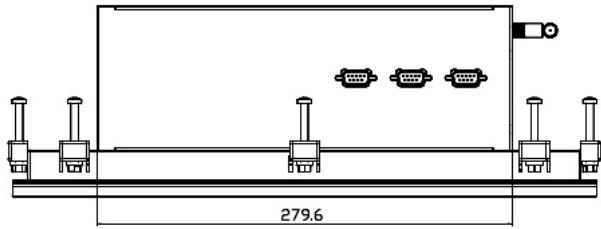

MPC1700CD-PCI Drawing

