

NVP Series

NETVIEW
KVM SWITCH SOLUTIONS



Model: NVP115 / NVP115-801 / NVP115-1601
1U Rack mount high bright 15" TFT LCD monitor
keyboard drawer / KVM switch

Features and Benefits:

- Only 1U (1.75" high) of vertical 19" rack-mount space.
- Laptop-style tilting display provides for short pull-out and minimal intrusion into the aisle space in front of the rack.
- High-brightness 450-nit, TFT LCD Panel and high contrast-ratio active TFT LCD flat panel integrated folding display.
- 15" display supporting 1024 x 768 resolutions.
- Full 101-keys Windows keyboard (including a dedicated numeric keypad), and an integrated touch-pad pointing device.
- Industrial-grade heavy-duty steel construction with a built-in lock to prevent unauthorized console access.
- Smooth-operating sliding rails that self-lock when pulled all the way out.
- Built in power supply
- Operating temperature 0 to 60 degree C
- Adjustable rear mounting support, up to 34-inches in depth.
- Built-in thumb screws for securing the unit when folded and pushed all the way in.
- Meets EIA310c & IEC-3 Specifications
- Add PCs or Remove Connected PCs for Maintenance without powering down the KVM switch for PCs

Mechanical Drawing:

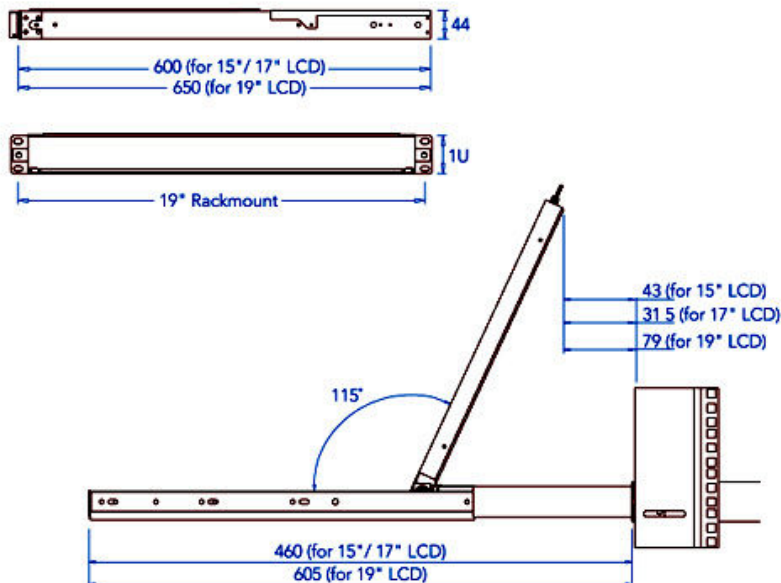

Unit : mm

KVM Features and Benefits: (with KVM options only)

- Multi-platform-mix PCs, SUNs, IBMs, HPs, Compaq & DELL
- Support 8 characters password protection & search PC server name
- Cascades for use with up to 128 servers
- New keep alive feature safeguards server for power loss to the switch
- Built-in microprocessor emulation for each port boots up process
- Auto scan-mode for monitoring your servers at intervals 5 to 99s
- Hot-pluggable when adding or removing PC w/o powering down the switch
- Name you server up to 16 characters long
- No software needed & all mounting hardware included

Specifications:

LCD	
Panel	Samsung 15" LCD Panel
Screen Type	TFT
Display Area	304.1 (H) x 228.1 (V) mm
Contrast Ratio	300 : 1
Viewing Angle	140 ° (H) x 120 ° (V) (Typ.)
Resolution	1024 x 768
Pixel pitch	0.297(H) x 0.297(W) mm
Response Time	Tr=5ms, Tf=20ms (Typ.)
Brightness	450 cd/m2
Panel Color	16.2M
Back Light	4 CCFTs (Cold Cathode Fluorescent tube)
Video	
Horizontal Synchronization	48 - 60 KHz (Typ.)
Vertical Synchronization	60 - 75 Hz (Typ.)
Input Signal	Analog RGB 0.7Vp-p
Power Management	
VESA DPMS	
Control	
OSD Control	Brightness, Contrast, Colour, Clock, H.Position, V.Position, Phase, Scaling, Auto config, Input select, Multi window, Clear EEPROM, OSD adjust, Save
External Connection	
Power Input	12V/5A DC adapter
Video Input	15-pin D-Sub connector
Dimension	
Product dimension	43.9(W) x 4.45(H) x 60(D)cm
Packing dimension	73.5(L) x 57.5(W) x 18(H)cm
KVM	
NVP115	Non
NVP115-801	8port
NVP115-1601	16port