

# NX Series

**Model: NX119CIP32e / NX119CIP32b**  
**1U Rack Mount 19" LCD Keyboard Drawer 32-port CAT 5 KVM Switch, 2 console (Local + KVM over IP)**



**NETVIEW**  
KVM SWITCH SOLUTIONS

## LCD Drawer & KVM Benefits:

- High density Cat5 KVM with either 16 or 32 ports in 1U
- Cost efficient DB-15KVM integration
- Single or "One Man" installation slide for easy, quick installation
- 104 key notepad keyboard with full numerical pad
- Mix PS/2, USB & SUN Multi-Platform switch capability
- Secure remote User access across the world wide web

## LCD Features:

- 1U rackmount drawer with either 17" or 19" SAMSUNG LCD
- Either PS/2 or USB input to the LCD Drawer by cable selection
- Multiple keyboard language selections with either touchpad or trackball
- slide rails with fixed positions to prevent drawer movement when typing
- Multi lingual on screen display menu
- 12, 24 and 48 volt DC power options

## KVM Features and Benefits:

- Use of the RJ45 Cat5 interface allows for a higher number of ports in smaller density
- Greater distances between your switch and servers allow enhanced data centre rack layouts
- Traditional Cat5 cords, when compared to coaxial cables, provide simple cable management
- Mix legacy PS/2 servers with newer USB and SUN solutions
- 128 bit secure browser based user access from anywhere in the world over IP
- Multi lingual on screen display menu
- Advanced user profiles and configurable OSD hot key combinations
- 12, 24 and 48 volt DC power options

## Mechanical Drawing:

### Diagram

Unit : mm

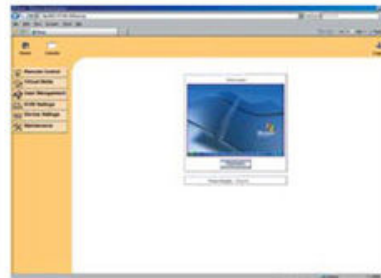
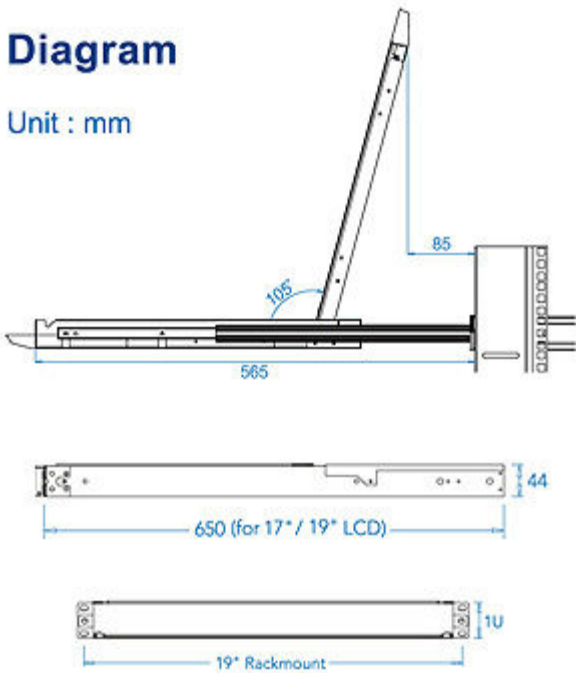

Remote Access Via Browser

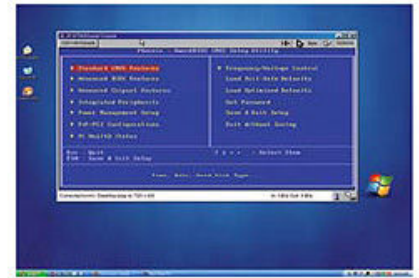

Access IP up to BIOS Level

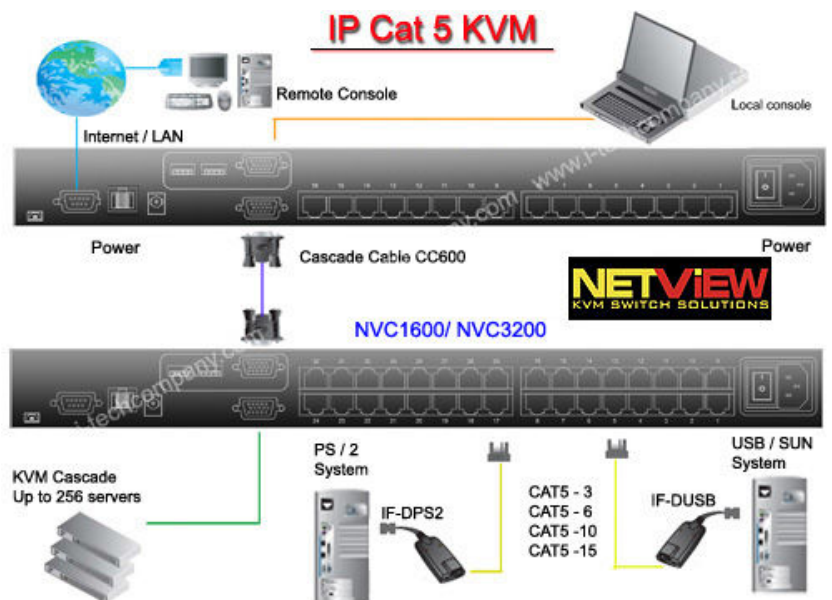

**e** keyboard integrated with touchpad

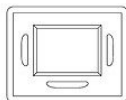
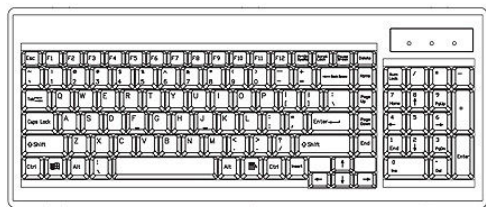

**b** keyboard integrated with trackball

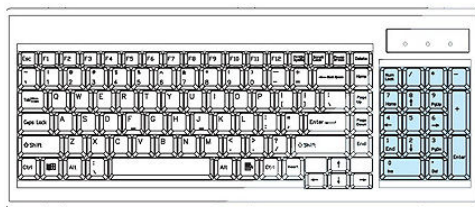

**Specifications:**

LCD	
Panel	Samsung 19" LCD Panel
Screen Type	TFT
Display Area	386.4(H) x 289.8(V) mm
Contrast Ratio	700 : 1
Viewing Angle	170 ° (H) x 170 ° (V) (Typ.)
Resolution	1280 x 1024
Pixel pitch	<b>0.242(H) x 0.242(W) mm</b>
Response Time	Tr=15ms, Tf=10ms (Typ.)
Brightness	250 cd/m2
Panel Color	16.7M
Back Light	4 CCFTs (Cold Cathode Fluorescent tube)
Video	
Horizontal Synchronization	64 KHz (Max.)
Vertical Synchronization	60 (Max.)
Input Signal	Analog RGB 0.7Vp-p
Power Management	
VESA DPMS	
Control	
OSD Control	Brightness, Contrast, Colour, Clock, H.Position, V.Position, Phase, Scaling, Auto config, Input select, Multi window, Clear EEPROM, OSD adjust, Save
External Connection	
Power Input	12V/5A DC adapter
Video Input	15-pin D-Sub connector

**KVM Technical Specifications:**

KVM Port	
Number of ports :	16or32
Connector:	RJ-45
Connectivity:	USB type or PS/2 type dongle, up to 40 meter ( 130 feet)
Local Console	
Graphic connector:	HDDB15-pin
Resolution:	Up to 1600x1200
Input device:	2 x USB type A for keyboard & mouse
IP Remote Console	
Connector:	RJ45 ethernet
User management:	15-user login, 1 x active user
Network protocol:	DHCP / BOOTP / DNS
Security:	SSL v3, RSA, AES, HTTP / HTTPs, CSR
Resolution:	1600x1200
Browser:	IE, Firefox, Safari, Netscape
Others:	Serial port, virtual media via USB
Expansion :	
	Up to 256 servers by 8-level cascade
Compatibility	
Multi-platform	Mix PCs, SUNs, IBMs, HPs, DELLs Server
:Support:	Windows Vista, 2003 / XP / 2000, Linux, Netware, Unix
Power	
Input:	100-240VAC, 50 or 60Hz, IEC type cord
Option DC :	12V/24V/48V DC input
Consumption :	Max. 25 Watt
Regulatory Approval	
	FCC,CE
Environmental	
Operating :	0 to 50°C
Storage:	-10 to 60-C
Relative humidity:	90%, non-condensing
Shock:	50G peak acceleration (11 ms, half-sine wave)
Vibration :	58~100Hz / 0.98G (11 min / cycle)