

DR Series

1U Rack Mount Dual Slide LCD Keyboard DVI KVM



1U Dual Slide 17" Widescreen LCD console drawer, 104-key MAC keyboard with touchpad, full HD 1080p resolution, with 12-port DVI-D only+ USB+ Audio KVM switch, Audio out x 1, Includes NC-6: 6pc 6ft long DVI +USB+ Audio KVM Cables, 650mm(26 inch) Deep

Model: DR117HD-12DMe



FEATURES:

- 1U dual slide 17" LCD console drawer
- Support Full HD with 1080p resolution
- 104-key keyboard with touchpad
- Short depth design of 650mm(26 inch) Deep
- Enhanced aesthetics with new molded front panel and two point lock
- 12-port DVI-D, USB & Audio KVM
- DVI-D single link support 1920 x 1200 transmission
- Support widescreen & native SUN 1152 x 900 resolution
- Multi-platform for PCs, SUN and Mac G3 / G4 Mac / iMac
- Hot pluggable, no software or drivers required

SPECIFICATIONS:

LCD Panel	
Diagonal size	17" TFT
Max. Resolution	1920 x 1080
Brightness (cd/m ²)	400
Backlight	LED
Colors	16.7 M, 8-bit
Contrast Ratio (typ)	600 : 1
Viewing Angle (H/V)	160° x 140°
Active area (mm)	382 x 215
MTBF (hrs)	50,000
Signal input	VGA or DVI-D
Casing Color	Black (RAL 9005)
Weight (Single console	
Net	11.9 kgs (26.2 lbs)
Gross	17.9 kgs (39.4 lbs)
Environmental	
Operating	0 to 50°C Degree
Storage	-5 to 60°C Degree
Relative humidity	5-90%, non-condensing
Shock	10G acceleration (11 ms duration)
Vibration	5-500Hz 1G RMS random vibration
Power	
Input	Auto-sensing 100 to 240VAC, 50 / 60Hz
Consumption	Max. 48 Watt, Standby 5 Watt
Product Dimensions (Single console)	
Product	441.6 x 650 x 44 mm / 17.4 x 25.6 x 1.73 inch
Packing	595 x 860 x 140 mm / 23.4 x 33.9 x 5.5 inch□



MAC Keyboard / Mouse Options

Me MAC keyboard integrated with touchpad

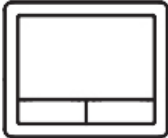

Mb MAC keyboard integrated with trackball



Supporting layouts

America



United States

How to Use "MAC" Keyboard

Keyboard Features

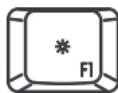

F1
Decrease display brightness



F9
Fast-forward



F2
Increase display brightness



F10
Mute sound



F3
Mission control
* Only works with OS X Lion
default Keyboard Shortcuts.



F11
Decrease volume



F4
Dashboard



F12
Increase volume

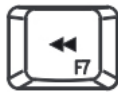

F7
Rewind



Eject disc

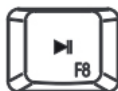

F8
Play / Pause



Command

STRUCTURE DIAGRAM

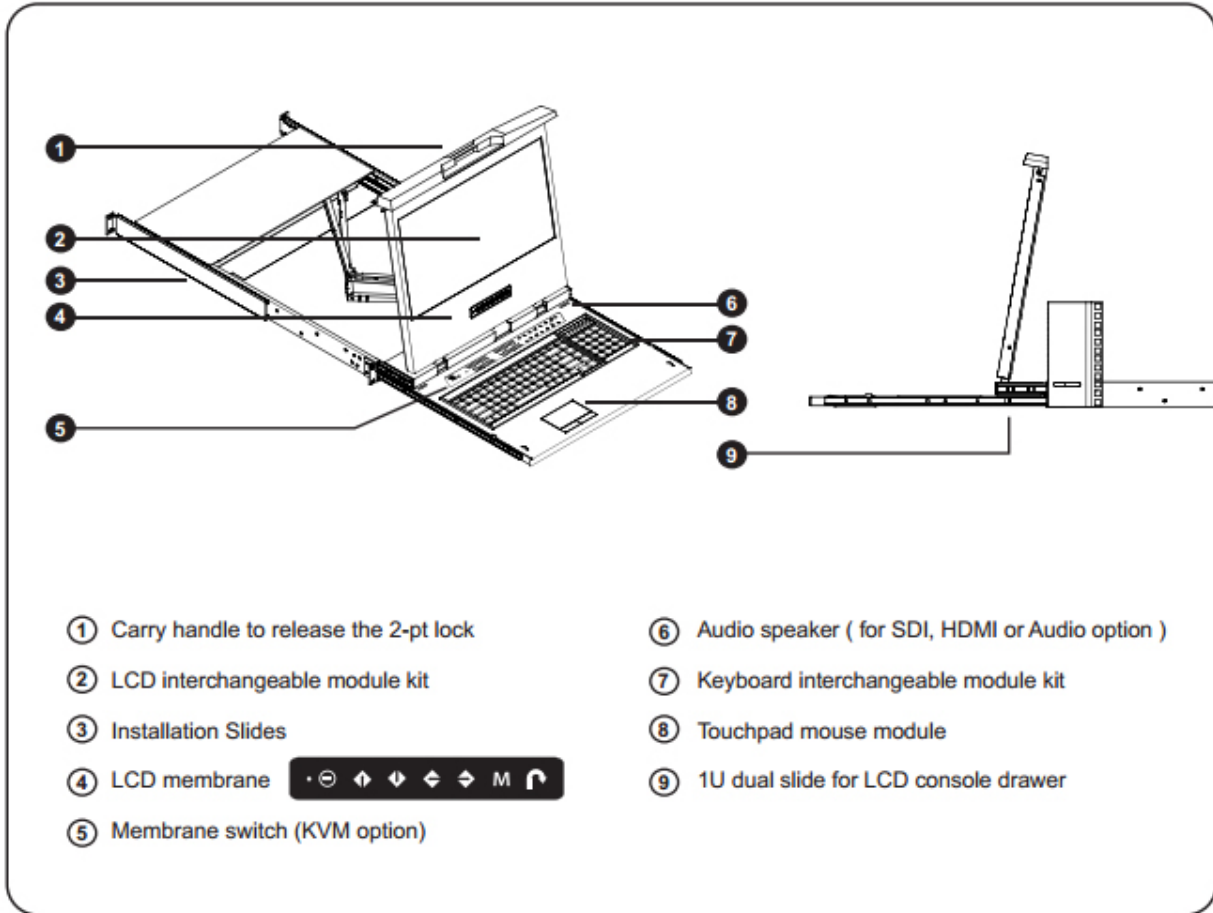

KVM PORT CONNECTION

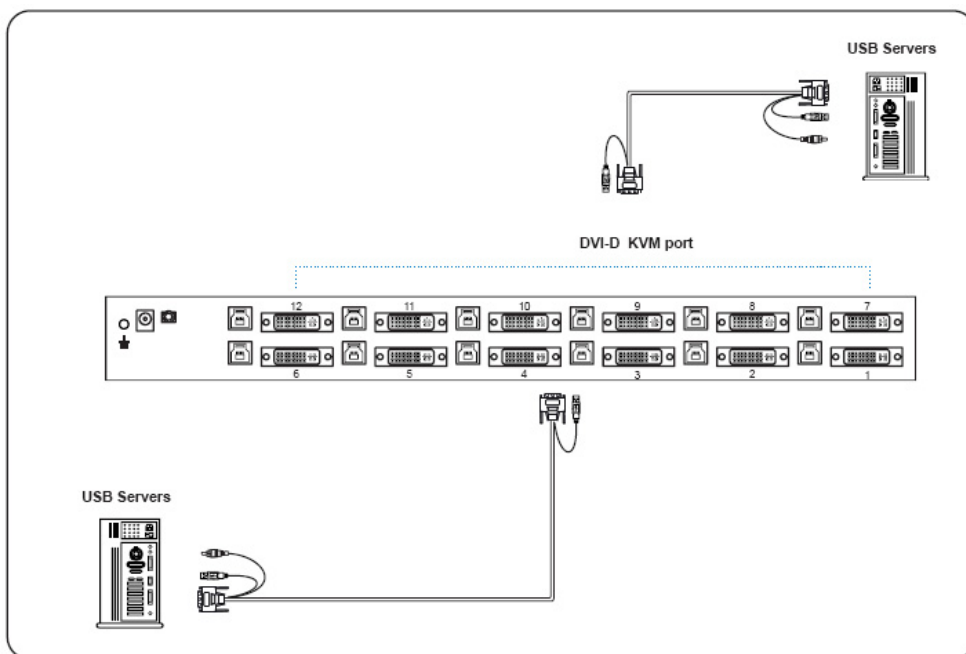

DVI KVM Cable
NC-6: 6 feet DVI KVM Cable
NC-15: 6 feet DVI KVM Cable (Server end : DVI-D+USB+Audio)
(KVM Port: DVI-D+USB 3.0)



DVI KVM SPECIFICATIONS

KVM Port	
Number of ports:	12
Connector:	DVI-D connector
	USB 3.0 connector (combined for keyboard, mouse & audio)
Connectivity:	Combo 4-in-1 KVM cable, 6 or 15 feet
Local Console	
Graphic connector:	1 x DVI-D
Resolution:	Up to 1920x1200
Input device:	2 x USB type A for keyboard & mouse
Audio out:	1 x 3.5mm stereo audio
Management	
PC Selection:	Front button & keyboard hotkey
Compatibility	
Multi-platform:	Mix PCs, SUN and Mac G3 / G4 Mac / iMac
Support:	Windows 7 / Vista / 2003 / XP, Linux, Unix

Regulatory	
Safety:	FCC & CE certified
Environment:	RoHS2 & REACH compliant
Environmental	
Operating:	0 to 50°C
Storage:	-5 to 60°C
Relative humidity:	90%, non-condensing
Shock:	50G peak acceleration (11ms, half-sine wave)
Vibration:	58-100Hz/0.98G (11ms/ cycle)

Front Panel - Port LED Indications

DVI-D KVM 12 ports

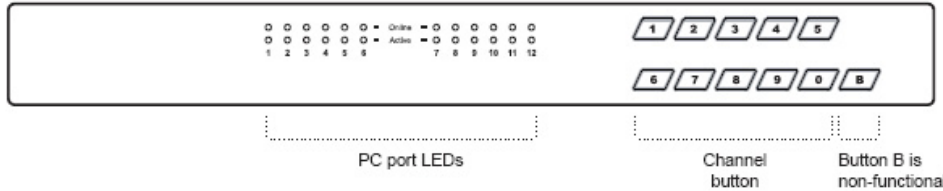

PC port LEDs	Online : Blue LED on indicating a PC is connecting to the port Active : Green LED on indicating a selected channel
Channel button	Press to select channel from 01 to 12