

# DR Series

## 1U Rack Mount Dual Slide LCD Keyboard DVI KVM



1U Dual Slide 17" Widescreen LCD console drawer, 104-key SUN keyboard with touchpad, full HD 1080p resolution, with 12-port DVI-D only+ USB+ Audio KVM switch, Audio out x 1, Includes NC-6: 6pc 6ft long DVI +USB+ Audio KVM Cables, 650mm(26 inch) Deep

Model: DR117HD-12DSe



### FEATURES:

- 1U dual slide 17" LCD console drawer
- Support Full HD with 1080p resolution
- 104-key keyboard with touchpad
- Short depth design of 650mm(26 inch) Deep
- Enhanced aesthetics with new molded front panel and two point lock
- 12-port DVI-D, USB & Audio KVM
- DVI-D single link support 1920 x 1200 transmission
- Support widescreen & native SUN 1152 x 900 resolution
- Multi-platform for PCs, SUN and Mac G3 / G4 Mac / iMac
- Hot pluggable, no software or drivers required

### SPECIFICATIONS:

LCD Panel	
Diagonal size	17" TFT
Max. Resolution	1920 x 1080
Brightness (cd/m <sup>2</sup> )	400
Backlight	LED
Colors	16.7 M, 8-bit
Contrast Ratio (typ)	600 : 1
Viewing Angle (H/V)	160° x 140°
Active area (mm)	382 x 215
MTBF (hrs)	50,000
Signal input	VGA or DVI-D
Casing Color	Black (RAL 9005)
Weight ( Single console	
Net	11.9 kgs ( 26.2 lbs )
Gross	17.9 kgs ( 39.4 lbs )
Environmental	
Operating	0 to 50°C Degree
Storage	-5 to 60°C Degree
Relative humidity	5~90%, non-condensing
Shock	10G acceleration ( 11 ms duration )
Vibration	5~500Hz 1G RMS random vibration
Power	
Input	Auto-sensing 100 to 240VAC, 50 / 60Hz
Consumption	Max. 48 Watt, Standby 5 Watt
Product Dimensions ( Single console )	
Product	441.6 x 650 x 44 mm / 17.4 x 25.6 x 1.73 inch
Packing	595 x 860 x 140 mm / 23.4 x 33.9 x 5.5 inch□



## SUN Keyboard / Mouse Options

**Se**

SUN keyboard integrated with touchpad

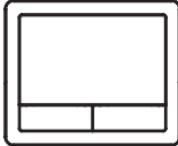
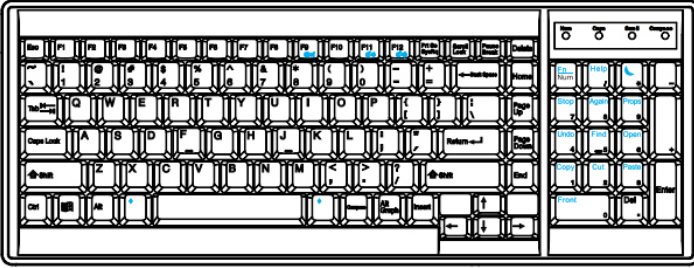

**Sb**

SUN keyboard integrated with trackball

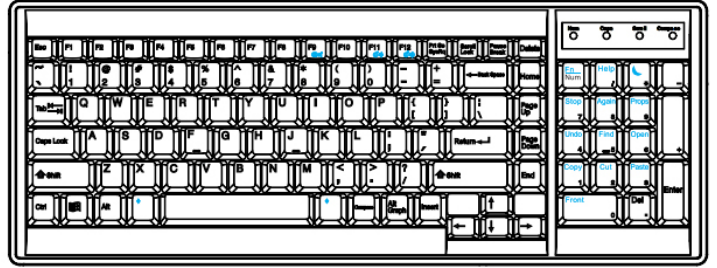

## SUN keyboard integrated with touchpad/trackball

- Incorporates SUN keys, including Stop, Cut, Paste, Compose, Copy and Help
- 104 key notepad keyboard with full numerical pad and SUN function
- USB interface
- US layout only

## How to Use "SUN" Keyboard

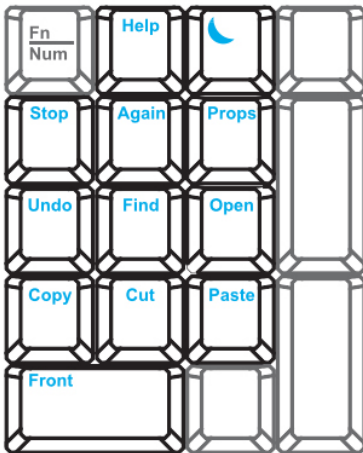

### Num LED in Off mode

Key pad behaves as a SUN Solar system administration command mode

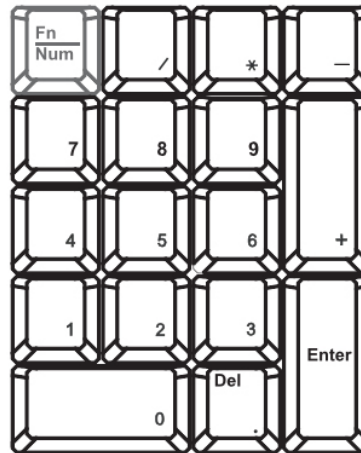

### Num LED in Green mode

Key pad behaves as a normal key pad mode

## Audio / Display Keys

\* Please ask your supplier for full details

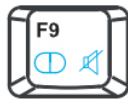

**F9**  
Audio : Mute  
Display : Degauss



**F11**  
Audio : Decrease volume  
Display : Decrease contrast



**F12**  
Audio : Increase volume  
Display : Increase contrast

## STRUCTURE DIAGRAM

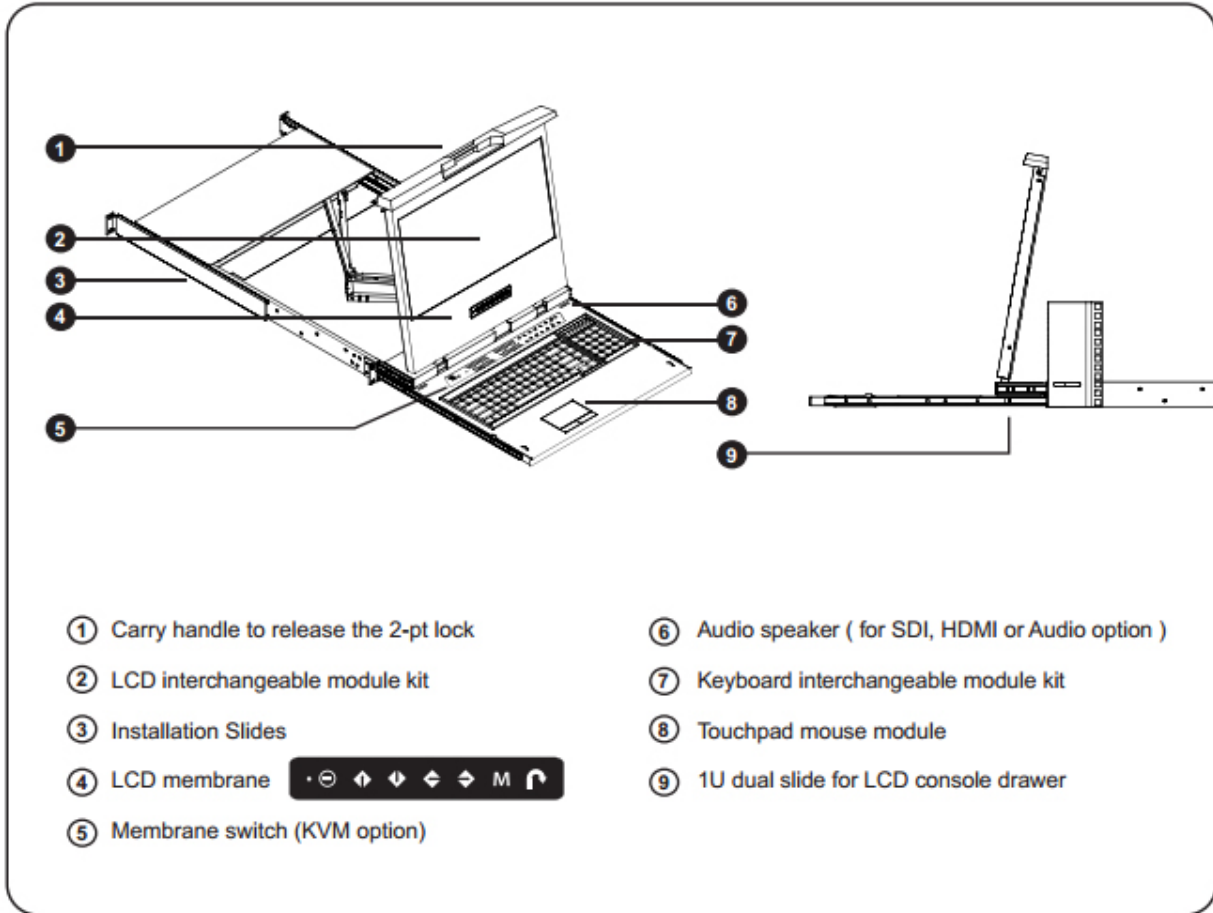

## KVM PORT CONNECTION

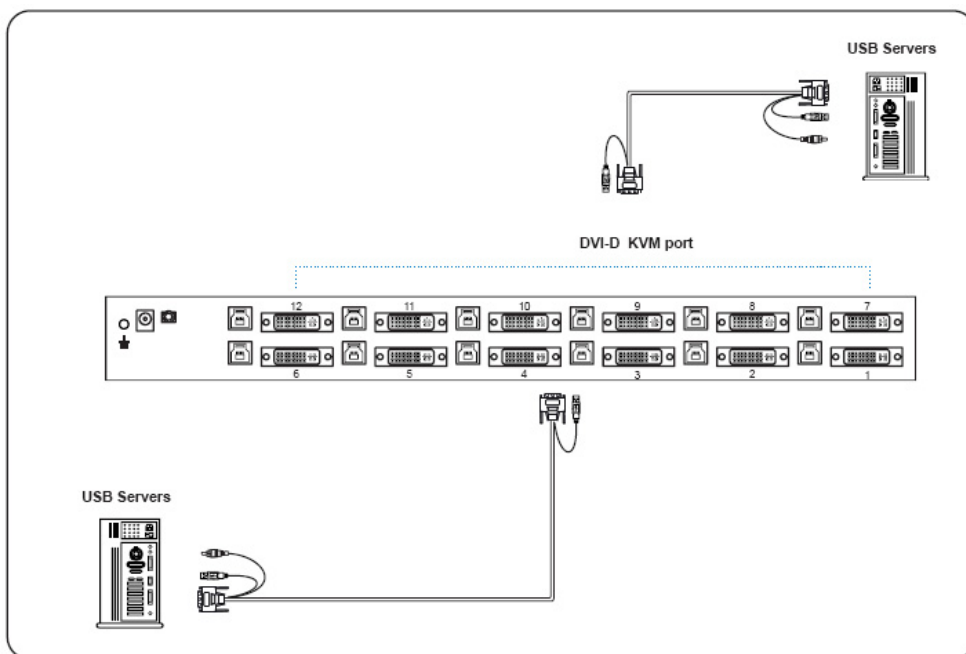

### DVI KVM Cable

NC-6: 6 feet DVI KVM Cable

NC-15: 6 feet DVI KVM Cable

(Server end : DVI-D+USB+Audio)

(KVM Port: DVI-D+USB 3.0)



## DVI KVM SPECIFICATIONS

<b>KVM Port</b>	
Number of ports:	12
Connector:	DVI-D connector
	USB 3.0 connector ( combined for keyboard, mouse & audio)
Connectivity:	Combo 4-in-1 KVM cable, 6 or 15 feet
<b>Local Console</b>	
Graphic connector:	1 x DVI-D
Resolution:	Up to 1920x1200
Input device:	2 x USB type A for keyboard & mouse
Audio out:	1 x 3.5mm stereo audio
<b>Management</b>	
PC Selection:	Front button & keyboard hotkey
<b>Compatibility</b>	
Multi-platform:	Mix PCs, SUN and Mac G3 / G4 Mac / iMac
Support:	Windows 7 / Vista / 2003 / XP, Linux, Unix

<b>Regulatory</b>	
Safety:	FCC & CE certified
Environment:	RoHS2 & REACH compliant
<b>Environmental</b>	
Operating:	0 to 50°C
Storage:	-5 to 60°C
Relative humidity:	90%, non-condensing
Shock:	50G peak acceleration (11ms, half-sine wave)
Vibration:	58-100Hz/0.98G (11ms/ cycle)

### Front Panel - Port LED Indications

#### DVI-D KVM 12 ports

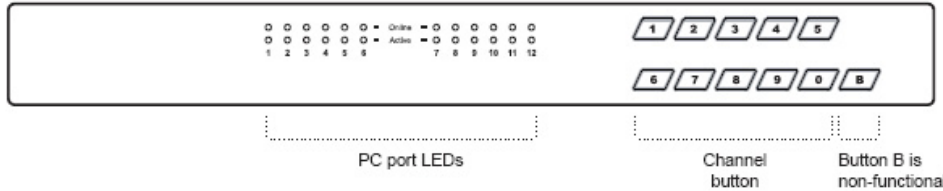

PC port LEDs	<b>Online</b> : Blue LED on indicating a PC is connecting to the port <b>Active</b> : Green LED on indicating a selected channel
Channel button	Press to select channel from 01 to 12