

DR Series

1U Rack Mount Dual Slide LCD DB-15 KVM Keyboard

Full HD
1080p

DB-15 KVM

1U Dual Slide 17" Widescreen LCD console drawer, full HD 1080p resolution, Matrix IP, DB-15,16-port KVM,3 consoles (1 x local; 1 x remote; 1 x IP) with 16 Dongles with 104 key notepad MAC keyboard w/ Touchpad (e), 26 inch Deep

Model: DR117HD-M1116Me



FEATURES:

- 1U dual slide 17" LCD console drawer
- Support Full HD with 1080p resolution
- 104-key MAC keyboard with touchpad
- Short depth design of 650mm(26 inch) Deep
- Enhanced aesthetics with new molded front panel and two point lock

SPECIFICATIONS:

LCD Panel	
Diagonal size	17" TFT
Max. Resolution	1920 x 1080
Brightness (cd/m2)	400
Backlight	LED
Colors	16.7 M, 8-bit
Contrast Ratio (typ)	600 : 1
Viewing Angle (H/V)	160° x 140°
Active area (mm)	382 x 215
MTBF (hrs)	50,000
Signal input	VGA or DVI-D
Casing Color	Black (RAL 9005)
Weight (Single console	
Net	11.9 kgs (26.2 lbs)
Gross	17.9 kgs (39.4 lbs)
Environmental	
Operating	0 to 50°C Degree
Storage	-5 to 60°C Degree
Relative humidity	5-90%, non-condensing
Shock	10G acceleration (11 ms duration)
Vibration	5-500Hz 1G RMS random vibration
Power	
Input	Auto-sensing 100 to 240VAC, 50 / 60Hz
Consumption	Max. 48 Watt, Standby 5 Watt
Product Dimensions (Single console)	
Product	441.6 x 650 x 44 mm / 17.4 x 25.6 x 1.73 inch
Packing	595 x 860 x 140 mm / 23.4 x 33.9 x 5.5 inch□

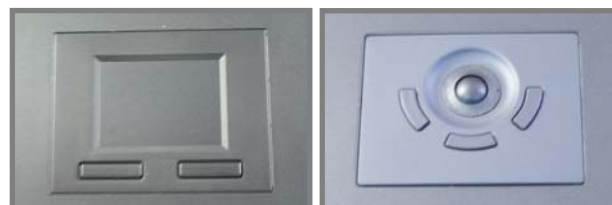

MAC Keyboard / Mouse Options

Me MAC keyboard integrated with touchpad



Mb MAC keyboard integrated with trackball



Supporting layouts

America



United States

How to Use "MAC" Keyboard

Keyboard Features



F1
Decrease display brightness



F9
Fast-forward



F2
Increase display brightness



F10
Mute sound



F3
Mission control
* Only works with OS X Lion
default Keyboard Shortcuts.



F11
Decrease volume



F4
Dashboard



F12
Increase volume

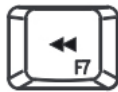

F7
Rewind



Eject disc



F8
Play / Pause



Command

STRUCTURE DIAGRAM

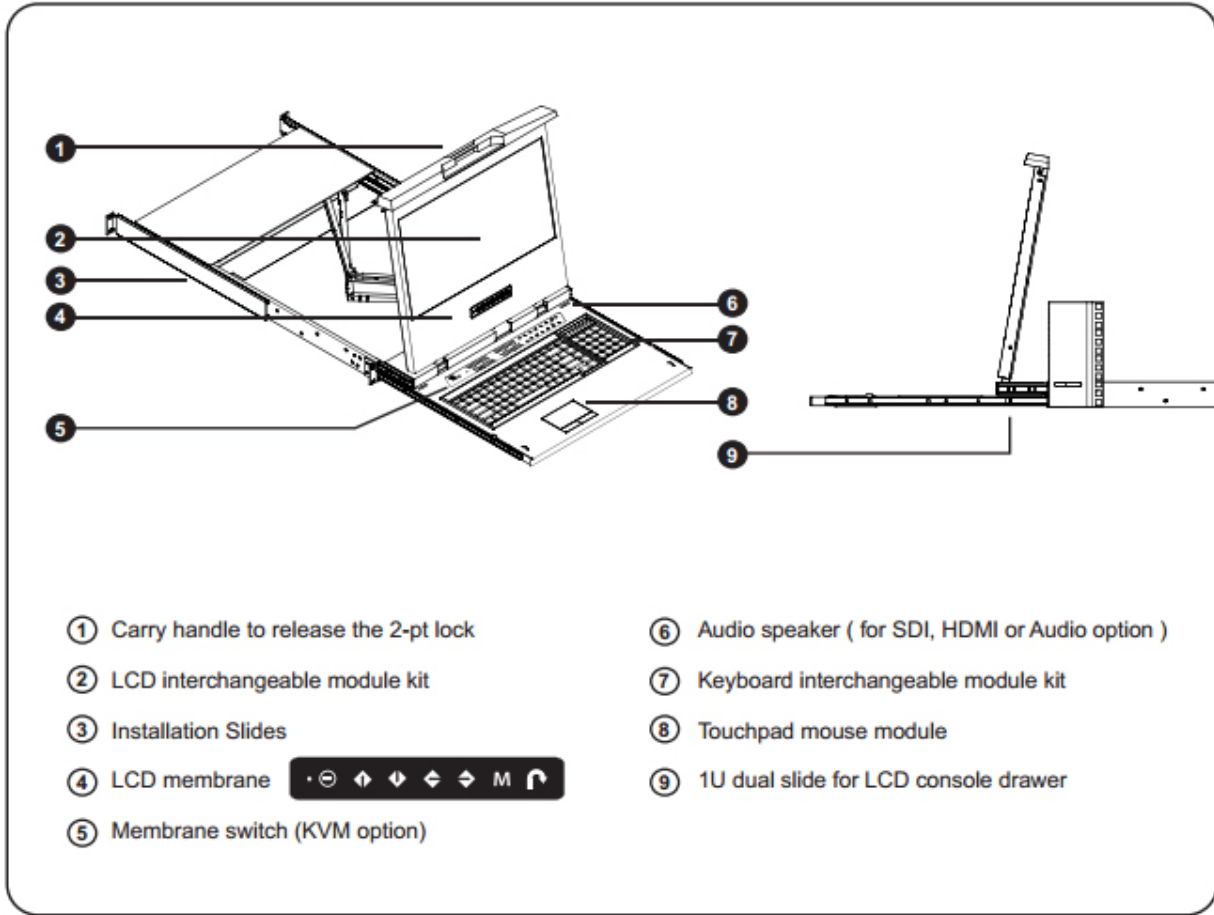

KVM PORT CONNECTION

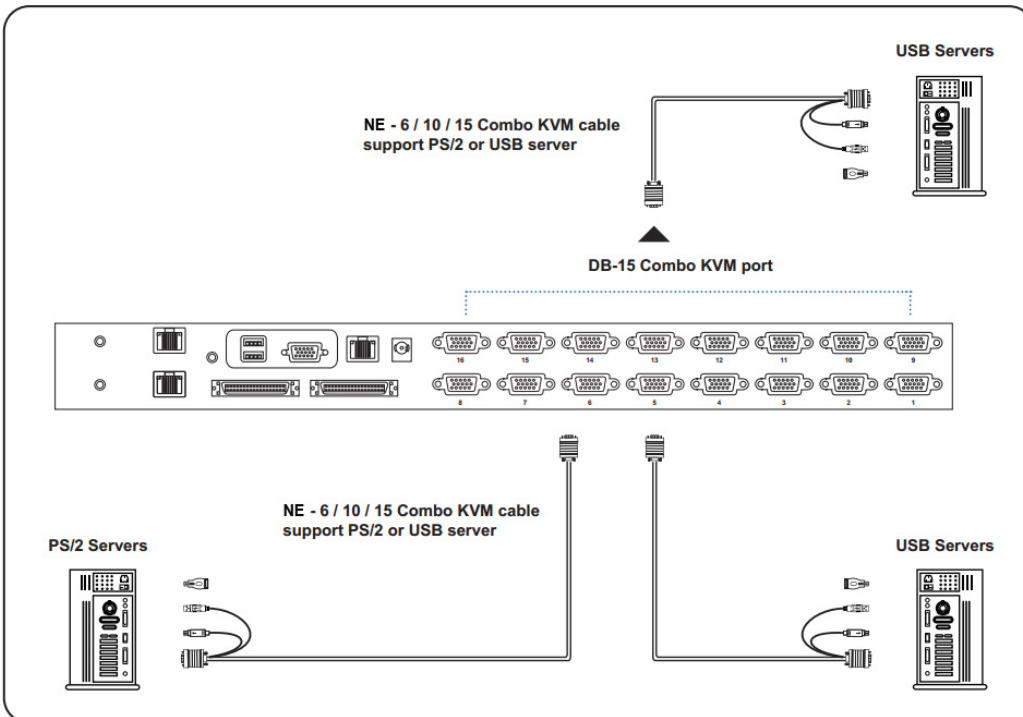

NE-6 / NE-10 / NE-15
 ■ 6 / 10 / 15 ft Combo KVM cable
 ■ Support PS/2 or USB server

Matrix DB-15 IP KVM Benefits

- Secure IP remote user access across the world wide web
- Efficient system management with simultaneous multi-user access
- Support resolution up to 1920 x 1080
- SUN 1152 x 900 resolution compatible
- Multi-platform servers shared by different consoles in cascade connection
- Mix PS/2, USB & SUN with Multi-Platform switch capability
- Extended Cat6 cord remote access up to 150 meters
- Provide a diversity of consoles to access servers independently & simultaneously

Switch Features & Options

- Mix legacy PS/2 servers with newer USB and SUN solutions
- Greater distances between your switch and servers allow enhanced data center rack layouts
- Multi lingual on screen display menu
- Advanced user profiles and configurable OSD hot key combinations

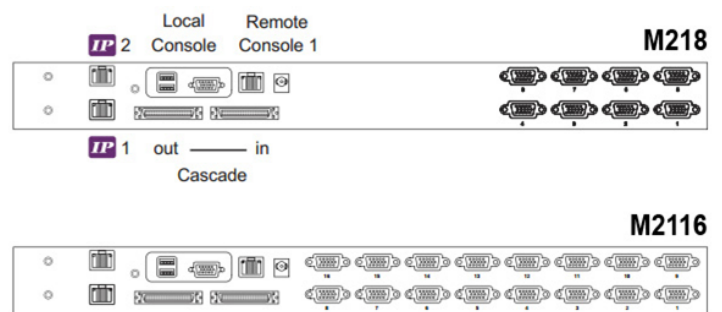
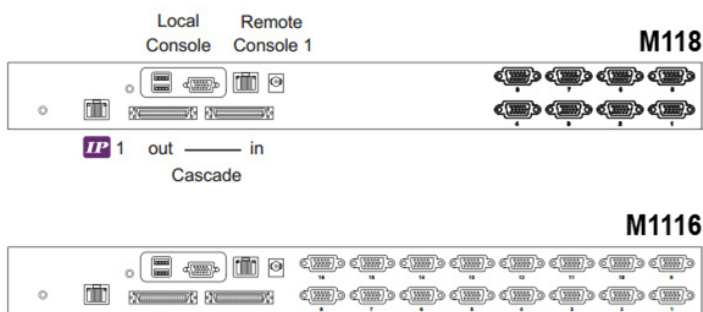

KVM SPECIFICATIONS

■ KVM Port	
Number of ports:	8 or 16
Connector:	DB-15 combo connector
Connectivity:	Combo 4-in-1 KVM cable up to 6, 10 & 15 feet
■ Local Console	
Monitor port:	1 x DB-15 VGA (Up to 1920 x 1080 / 1920 x 1200)
Keyboard & mouse port:	2 x USB type connector for keyboard & mouse
■ CAT6 Remote Console	
Number of remote port:	1
Monitor port:	DB15-pin VGA (Up to 1600 x 1200)
Keyboard & mouse port:	2 x USB type connector for keyboard & mouse
Remote I/O:	RJ45 via Cat5 / Cat5e / Cat6 cable up to 500 feet
■ IP Remote Console	
Number of IP console:	1 for M118 / M1116 2 for M218 / M2116
User management:	15-user login, 1 x active user
Browser:	Internet Explorer, Firefox, Safari
Security:	SSL v3, RSA, AES, HTTP / HTTPS, CSR
IP Access:	RJ45 Ethernet per IP console
■ Expansion	Up to 240 servers by 8-level cascade

■ Compatibility	
Multi-platform:	Mix PCs, SUN and Mac G3 / G4 Mac / iMac
Support:	Windows 7 / Vista / 2003 / XP, Linux, Unix
■ Power	
Input:	AC power adapter
Consumption:	Max. 48 Watt, Standby 5 Watt
■ Regulatory :	
Safety:	cUL, FCC & CE certified
Environment:	RoHS2 & REACH compliant
■ Environmental	
Operating:	0 to 50°C
Storage:	-5 to 60°C
Relative humidity:	90%, non-condensing
Shock:	50G peak acceleration (11ms, half-sine wave)
Vibration:	58-100Hz / 0.98G (11ms / cycle)
■ Product Information	
Dimension (W x D x H):	443 x 171 x 44 mm / 17.4 x 6.7 x 1.73 inch
Net weight:	3 kg / 6.5 lb
■ Packing Information	
Dimension (W x D x H):	500 x 400 x 90 mm / 19.7 x 15.7 x 3.5 inch
Gross weight:	5 kg / 11 lb

IP, REMOTE & LOCAL CONSOLE CONNECTION

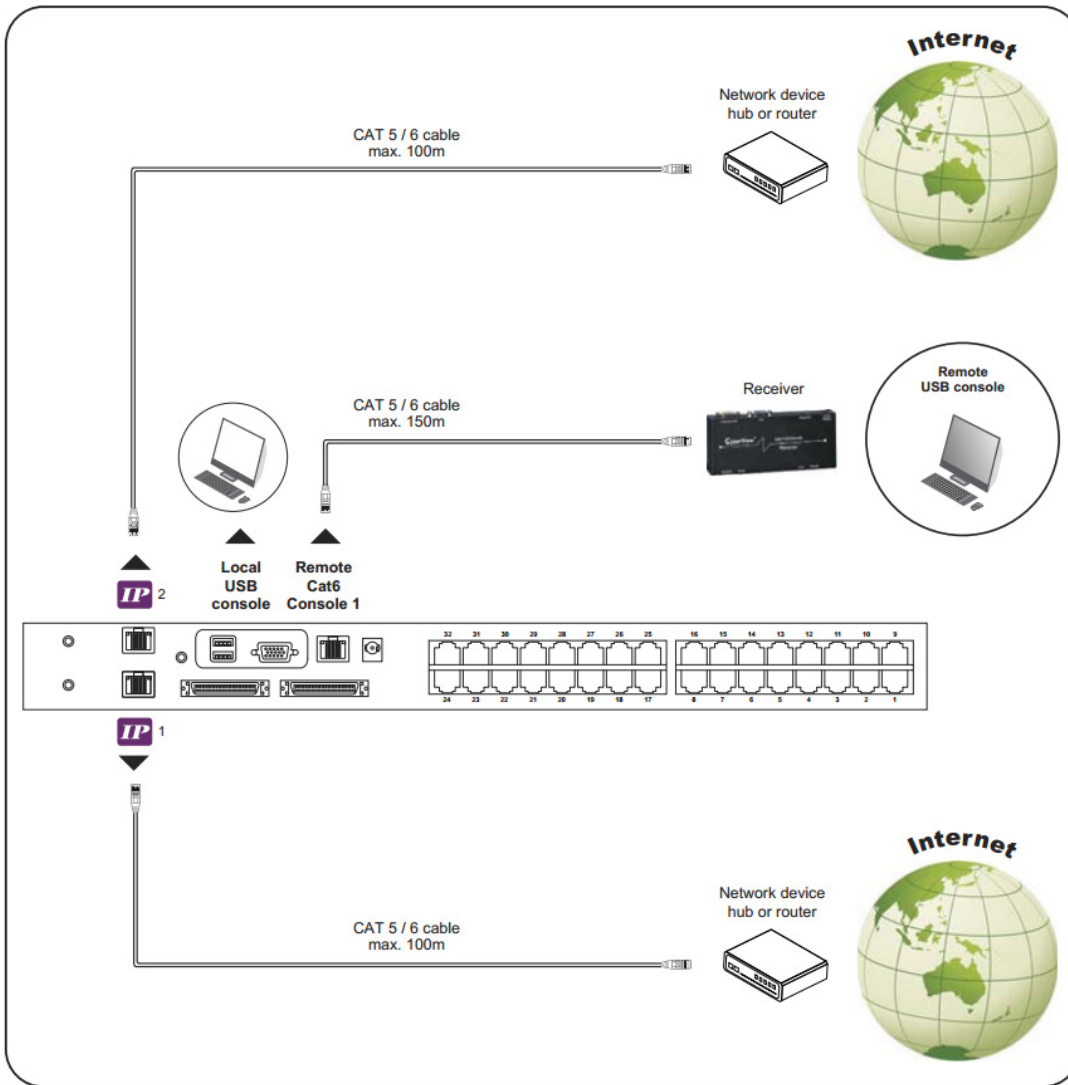

KVM CASCADE

- Cascade up to 8 levels, 240 servers
- Cascading multiple KVM with CMC-8 cascade cable

Master KVM

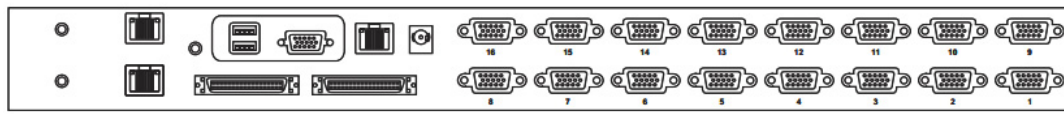

out — in
Cascade

To cascade IN port

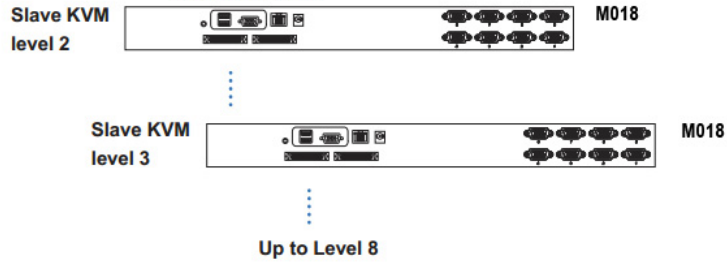

Cascaded KVMs from level 2 to 8 must be the models of M018 / M0116 or MC0116 / MC0132.



When multiple matrix KVMs cascade together, the master KVM at level 1 will take all control of other slave KVM switches (e.g. level 2 to 8).



The slave matrix KVM will be as a port expansion module of the master matrix KVM, the original remote console on slave KVM will be sacrificed and disabled.



CMC-8

- 8ft Matrix KVM cascade cable