

1U Rackmount 19" TFT SAMSUNG LCD Monitor w/notebook keyboard & touch-pad mouse Drawer 1280x1024 resolution

Remarks:

- 1) This model is in 2009-style which has 2-point lock in the front handle, and the handle is 1/2" sticking out from the front mounting bracket only.
- 2) CAC reader is integrated into NVP119e Front next to the keyboard.

Model: NVP119-CAC-e



LCD DRAWER & KVM BENEFITS

- 1U 19" LCD console drawer
- 104-key keyboard with either touchpad or trackball
- Short depth design of 460mm and 500mm respectively
- New enhanced aesthetics with molded front handle
- Front USB port for device access (USB Hub KVM only)
- 2 post rack mounting available

DRAWER FEATURES & OPTIONS

- S-Video + Composite (BNC) or Audio input
- HDMI or DVI-D (either one)
- 48V, 24V or 12VDC power

CAC READER SPECS:

- DOD Military CAC USB Smart Card Reader for CAC Cards, Government ID, National ID, ActivClient, AKO, OWA, DKO, JKO, NKO, BOL, GKO, Marinenet, AF Portal, Pure Edge Viewer, Approvelt, DCO, DTS, LPS, Disa Enterprise Email etc.
- Compatible with windows (32/64bit) XP/Vista/ 7/8/10, Mac OS X
- Support Card types: 5V, 3V and 1.8V Smart Cards, ISO 7816 Class A, B and C.
- Certifications Standards: ISO-7816 & EMV2 2000 Level 1, CE, FCC, VCCI, CCID, Microsoft WHQL ; And RECOMMENDED by militarvcac.com

LCD Panel	
Manufacturer	
Diagonal size	19" TFT
Max. Resolution	1280 x 1024
Brightness (cd/m2)	250
Backlight	LED
Colors	16.7M
Contrast Ratio (typ)	1000 : 1
Viewing Angle (H/V)	160° x 160°
Active area (mm)	376 x 301
MTBF (hrs)	30,000
Signal input	VGA
Casing Color	Black (RAL 9005)
Weight (Single console)	
Net	12.7 kgs (27.9 lbs)
Gross	17.3 kgs (38.1 lbs)
Environmental	
Operating	0 to 50°C Degree
Storage	-5 to 60°C Degree
Relative humidity	5~90%, non-condensing
Shock	10G acceleration (11 ms duration)
Vibration	5~500Hz 1G RMS random vibration
Regulatory	cUL, FCC, CE

Power	
Input	Auto-sensing 100 to 240VAC, 50 / 60Hz
Consumption	Max. 48 Watt, Standby 5 Watt
Product Dimensions (Single console)	
NVP119-CAC-e	441.6 x 500 x 44 mm / 17.4 x 19.7 x 1.73 inch

CONSOLE CABLE

NE-6

6 feet Combo KVM cable (bundle)

- VGA + USB or PS/2, server end

- DB15 (VGA, USB KB & MS), console port

DIMENSIONS

Model	Product Dimension (W x D x H)	Packing Dimension (W x D x H)	Net Weight	Gross Weight
NVP119-CAC-e	441.6 x 500 x 44 mm 17.4 x 19.7 x 1.73"	590 x 823 x 140 mm 23.2 x 32.4 x 5.5"	12.7 kg 27.9 lb	17.3 kg 38.1 lb

KEYBOARD SELECTION Supporting layouts

e keyboard integrated with touchpad



b keyboard integrated with trackball

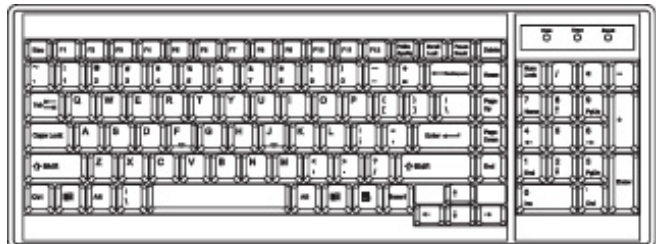
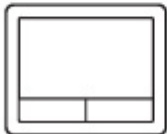
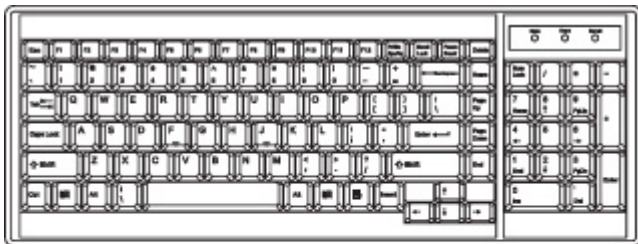

STRUCTURE DIAGRAM

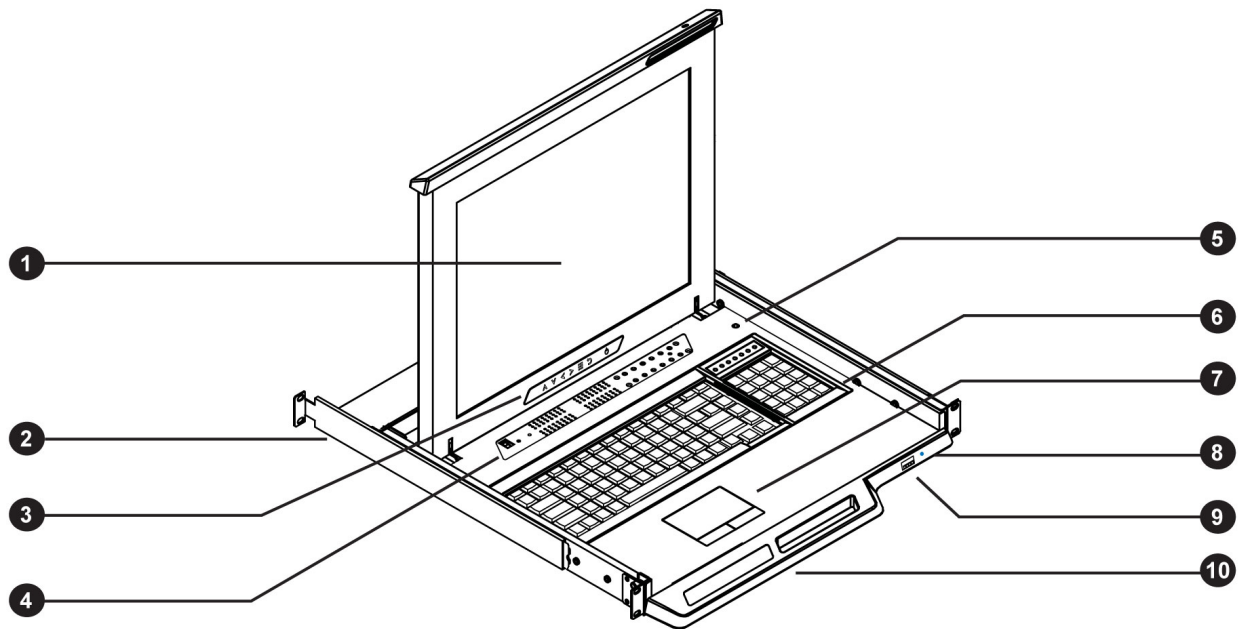

① LCD interchangeable module kit

② Installation Slides

③ LCD membrane



④ Membrane switch (KVM option)

⑤ Micro switch for screen auto power off

⑥ Keyboard interchangeable module kit

⑦ Mouse interchangeable module kit

⑧ Blue Power LED

⑨ Front USB port for device access (USB Hub KVM only)

⑩ Molded front handle

DIMENSION

Life-Side View

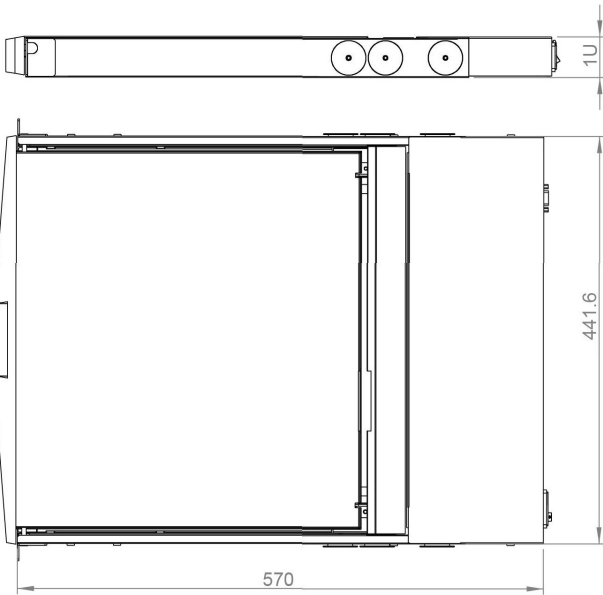

Top View

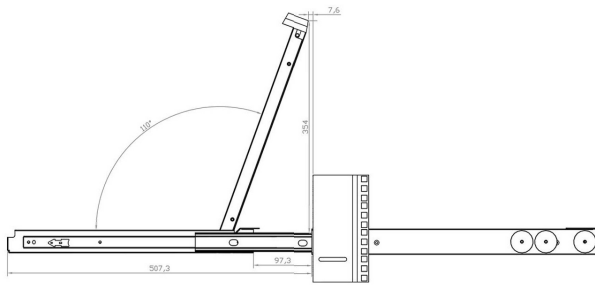

Lockable Railway

Front View



AC input 100-240V

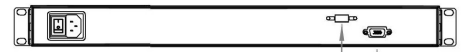
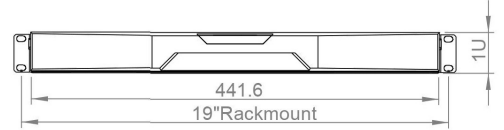

Rear USB Port for CAC Card Reader

All in one RGB and Keyboard combo PS USB connectors

