

USB HUB KVM

NetView: 1U Rackmount 21" Wide 1920 x 1080 LCD KVM with 104 key notepad Sun Compatible Keyboard w/ Trackball (b), Integrated with DB-15, 8 KVM Ports + 0 User Via CAT5 Extender + 0 Users Via KVM over IP. Over Depth is 30 Inch. Dongles sold separately

Model: NVPW1215-B8Sb

FEATURES:

- 1U 21" widescreen LCD console drawer
- Support Full HD with 1080p resolution
- 104-key notepad SUN Compatible keyboard with trackball
- New enhanced aesthetics with molded front handle

Drawer Features & Options

- 3G / HD / SD-SDI Broadcast-grade input (w/ speaker)
- HDMI (w/ speaker)
- DC power : 12V / 24V / 48V / 110 ~ 125V

SPECIFICATIONS:

LCD Panel	
Diagonal size	21.5" widescreen TFT
Max. Resolution	1920 x 1080
Brightness (cd/m2)	250
Backlight	LED
Colors	16.7M
Contrast Ratio (typ)	1000 : 1
Viewing Angle (H/V)	170° x 160°
Active area (mm)	477 x 268
MTBF (hrs)	30,000
Casing Color	Black (RAL 9005)
Weight (Single console	
Net	14.7 kgs / 32.3 lbs
Gross	18.9 kgs / 41.6 lbs
Environmental	
Operating	0 to 55°C Degree
Storage	-20 to 60°C Degree
Relative humidity	5-90%, non-condensing
Shock	10G acceleration (11 ms duration)
Vibration	5-500Hz 1G RMS random vibration
Regulatory	FCC & CE certified
Power	
Input	Auto-sensing 100 to 240VAC, 50 / 60Hz
Consumption	Max. 32 Watt, Standby 4 Watt
Product Dimensions (Single console)	
Product	441.6 x 670 x 44 mm / 17.4 x 26.4 x 1.73 inch
Packing	595 x 860 x 140 mm / 23.4 x 33.9 x 5.5 inch



SUN Keyboard / Mouse Options

Se

SUN keyboard integrated with touchpad



Sb

SUN keyboard integrated with trackball



SUN keyboard integrated with touchpad/trackball

- Incorporates SUN keys, including Stop, Cut, Paste, Compose, Copy and Help
- 104 key notepad keyboard with full numerical pad and SUN function
- USB interface
- US layout only

How to Use "SUN" Keyboard



Num LED in Off mode

Key pad behaves as a SUN Solar system administration command mode



Num LED in Green mode

Key pad behaves as a normal key pad mode

Audio / Display Keys

* Please ask your supplier for full details



F9
Audio : Mute
Display : Degauss



F11
Audio : Decrease volume
Display : Decrease contrast



F12
Audio : Increase volume
Display : Increase contrast



- Hold the handle and slide out the drawer.



- Flip up the LCD to a suitable angle



- Operate the LCD console drawer.



Option - Right Side Open

DIMENSION

Front View



Rear View



Side View



UNIT : mm
1mm = 0.03937 inch

Top View



STANDARD KEYBOARD

e keyboard integrated with touchpad



b keyboard integrated with trackball



Supporting layouts

America					
	United States				
EMEA					
	United Kingdom	Germany	France	Spain	Norway
	Italy	Russia	Switzerland	Netherlands	Portugal
Asia	China	Japan	Korea	Arabia	Turkey

STRUCTURE DIAGRAM

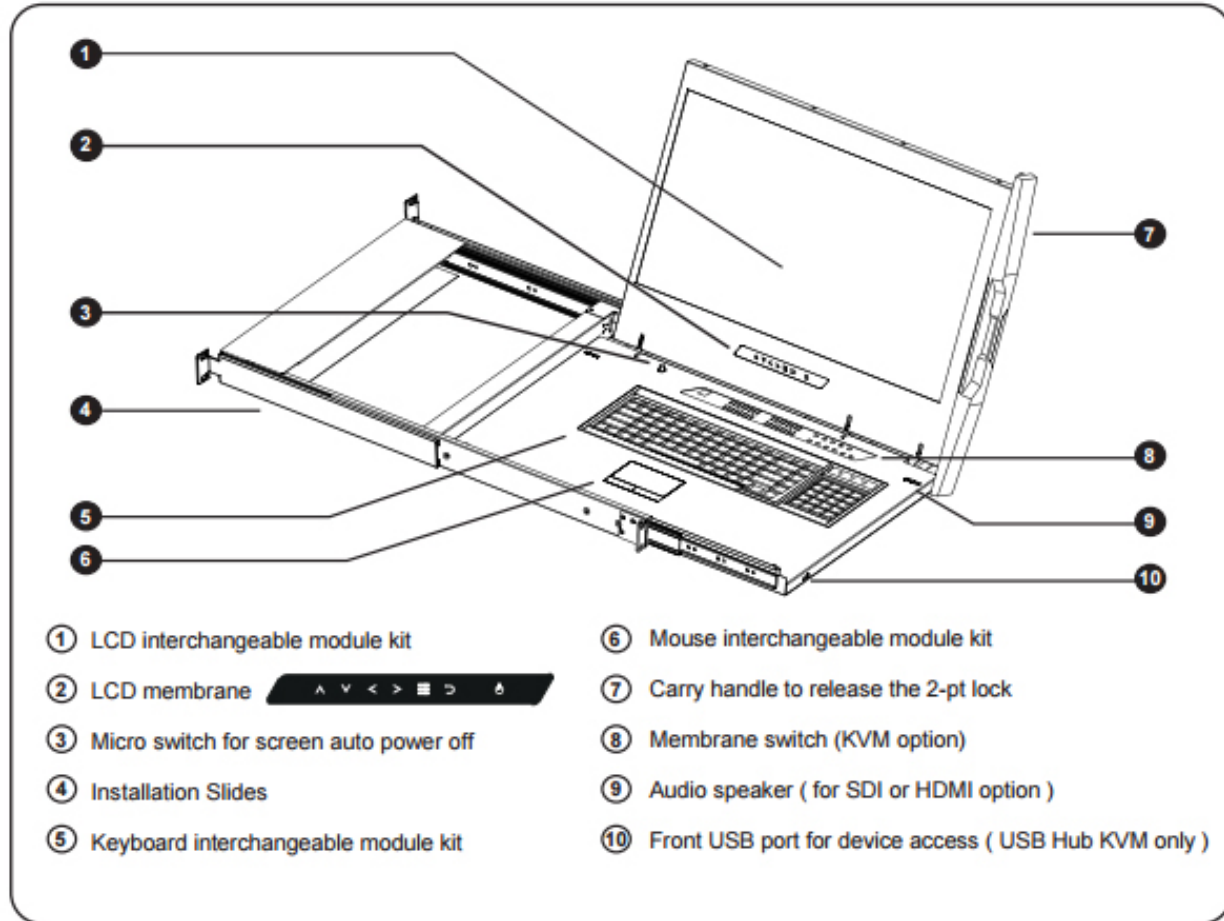

BUILT-IN USB HUB USAGE & CONNECTION



USB Hub DB-15 IP KVM Benefits

- VGA-USB DB-15 KVM with either 8 or 16 ports in 1U
- IP remote access across the world wide web
- 2 x USB 2.0 port sharing USB peripheral for computers
- Mix USB & SUN with Multi-Platform switch capability
- Support resolution up to 1920 x 1080
- SUN 1152 x 900 resolution compatible
- Hot pluggable, no software or drivers required
- Easy & quick installation

Switch Features & Options

- Multi lingual on screen display menu
- Control hardware and software systems from a remote location without physically being at the server's location
- Advanced user profiles and configurable OSD hot key combinations
- 12V, 24V and 48V DC Power options

Note: No Daisy chain function on USB Hub KVM model



Real View



KVM SPECIFICATIONS

■ KVM Port	
Number of ports:	8 or 16
Connector:	DB-15 combo connector
Connectivity:	Combo 2-in-1 VGA + USB KVM cable, 6, 10 or 15 feet
■ Local Console	
Graphic connector:	1 x DB-15
Resolution:	Up to 1920x1200
Input device:	2 x USB type A for keyboard & mouse
USB hub:	2 x USB type A for sharing other peripheral devices among the computers
■ IP Remote Console	
Connector:	RJ45 Ethernet
User management:	15-user login, 1 x active user
Network protocol:	DHCP / BOOTP / DNS
Security:	SSL v3, RSA, AES, HTTP / HTTPS, CSR
Resolution:	Up to 1600 x 1200
Browser:	IE, Firefox, Safari, Netscape
■ Compatibility	
Multi-platform:	Mix PCs, SUN and Mac G3 / G4 Mac / iMac
Support:	Windows 7 / Vista / 2003 / XP, Linux, Unix

■ Power	
Input:	Auto sensing 100 to 240VAC, 50 / 60 Hz
Option DC:	12V / 24V / 48V DC input
Consumption:	Max. 12 Watt, Standby 5 Watt
■ Regulatory :	
Safety:	FCC & CE certified
Environment:	RoHS2 & REACH compliant
■ Environmental	
Operating:	0 to 50°C
Storage:	-5 to 60°C
Relative humidity:	90%, non-condensing
Shock:	50G peak acceleration (11ms, half-sine wave)
Vibration:	58-100Hz / 0.98G (11ms / cycle)
■ Product Information	
Dimension (W x D x H):	443 x 171 x 44 mm / 17.4 x 6.7 x 1.73 inch
Net weight:	3 kg / 6.5 lb
■ Packing Information	
Dimension (W x D x H):	500 x 400 x 90 mm / 19.7 x 15.7 x 3.5 inch
Gross weight:	5 kg / 11 lb

KVM PORT CONNECTION



IP & Local console connection

