

CAT6 KVM

NetView: 1U Rackmount 21" Wide 1920 x 1080 LCD KVM with 104 key notepad Sun Compatible Keyboard w/ Trackball (b), Integrated with Combo Cat6,8 KVM Ports + 0 User Via CAT5 Extender + 1 Users Via KVM over IP. Over Depth is 30 Inch. Dongles sold separately

Model: NVPW1215CIP8Sb

FEATURES:

- 1U 21" widescreen LCD console drawer
- Support Full HD with 1080p resolution
- 104-key notepad SUN Compatible keyboard with trackball
- New enhanced aesthetics with molded front handle

Drawer Features & Options

- 3G / HD / SD-SDI Broadcast-grade input (w/ speaker)
- HDMI (w/ speaker)
- DC power : 12V / 24V / 48V / 110 ~ 125V

SPECIFICATIONS:

LCD Panel	
Diagonal size	21.5" widescreen TFT
Max. Resolution	1920 x 1080
Brightness (cd/m2)	250
Backlight	LED
Colors	16.7M
Contrast Ratio (typ)	1000 : 1
Viewing Angle (H/V)	170° x 160°
Active area (mm)	477 x 268
MTBF (hrs)	30,000
Casing Color	Black (RAL 9005)
Weight (Single console	
Net	14.7 kgs / 32.3 lbs
Gross	18.9 kgs / 41.6 lbs
Environmental	
Operating	0 to 55°C Degree
Storage	-20 to 60°C Degree
Relative humidity	5-90%, non-condensing
Shock	10G acceleration (11 ms duration)
Vibration	5-500Hz 1G RMS random vibration
Regulatory	FCC & CE certified
Power	
Input	Auto-sensing 100 to 240VAC, 50 / 60Hz
Consumption	Max. 32 Watt, Standby 4 Watt
Product Dimensions (Single console)	
Product	441.6 x 670 x 44 mm / 17.4 x 26.4 x 1.73 inch
Packing	595 x 860 x 140 mm / 23.4 x 33.9 x 5.5 inch

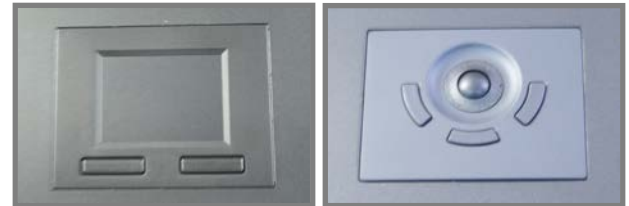

SUN Keyboard / Mouse Options

Se

SUN keyboard integrated with touchpad



Sb

SUN keyboard integrated with trackball



SUN keyboard integrated with touchpad/trackball

- Incorporates SUN keys, including Stop, Cut, Paste, Compose, Copy and Help
- 104 key notepad keyboard with full numerical pad and SUN function
- USB interface
- US layout only

How to Use "SUN" Keyboard



Num LED in Off mode

Key pad behaves as a SUN Solar system administration command mode



Num LED in Green mode

Key pad behaves as a normal key pad mode

Audio / Display Keys

* Please ask your supplier for full details



F9
Audio : Mute
Display : Degauss



F11
Audio : Decrease volume
Display : Decrease contrast



F12
Audio : Increase volume
Display : Increase contrast



- Hold the handle and slide out the drawer.



- Flip up the LCD to a suitable angle



- Operate the LCD console drawer.



Option - Right Side Open

DIMENSION

Front View



Rear View



Side View



UNIT : mm
1mm = 0.03937 inch

Top View



STANDARD KEYBOARD

e keyboard integrated with touchpad

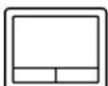

b keyboard integrated with trackball



Supporting layouts

America



United States

EMEA



United Kingdom



Germany



France



Spain



Norway



Italy



Russia



Switzerland



Netherlands



Portugal

Asia



China



Japan



Korea



Arabia



Turkey

STRUCTURE DIAGRAM



KVM PORT & CAT6 DONGLE CONNECTION

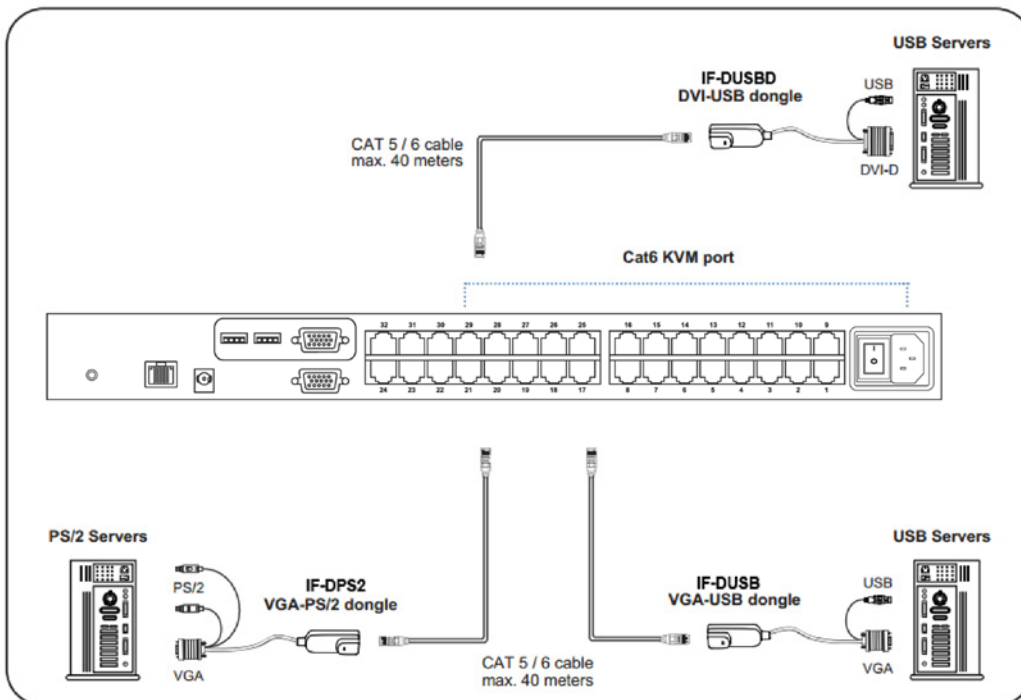

IF-DUSBD DVI-USB dongle

- To connect DVI-D connector to the computer's video card
- To connect USB connector to the computer's USB port



IF-DUSB VGA-USB dongle

- To connect DB-15 connector to the computer's video card
- To connect USB connector to the computer's USB port



IF-DPS2 VGA-PS/2 dongle

- To connect DB-15 connector to the computer's video card
- To connect PS/2 keyboard connector to the computer's keyboard port
- To connect PS/2 mouse connector to the computer's mouse port

Cat6 Dongle	EDID Resolution Hard-coded	Resolutions Capable			
		4:3			16:10
		1024 x 768	1280 x 1024	1600 x 1200	1440 x 900
IF-DPS2	1600 x 1200	✓	✓	✓	✓*
IF-DUSB	1600 x 1200	✓	✓	✓	✓*
IF-DUSBD	1280 x 1024	✓	✓	✗	✗

* Requires the user to enable showing unsupported resolutions via the target computer's video adapter settings (effectively ignoring the DDC / EDID)

IP & LOCAL CONSOLE CONNECTION

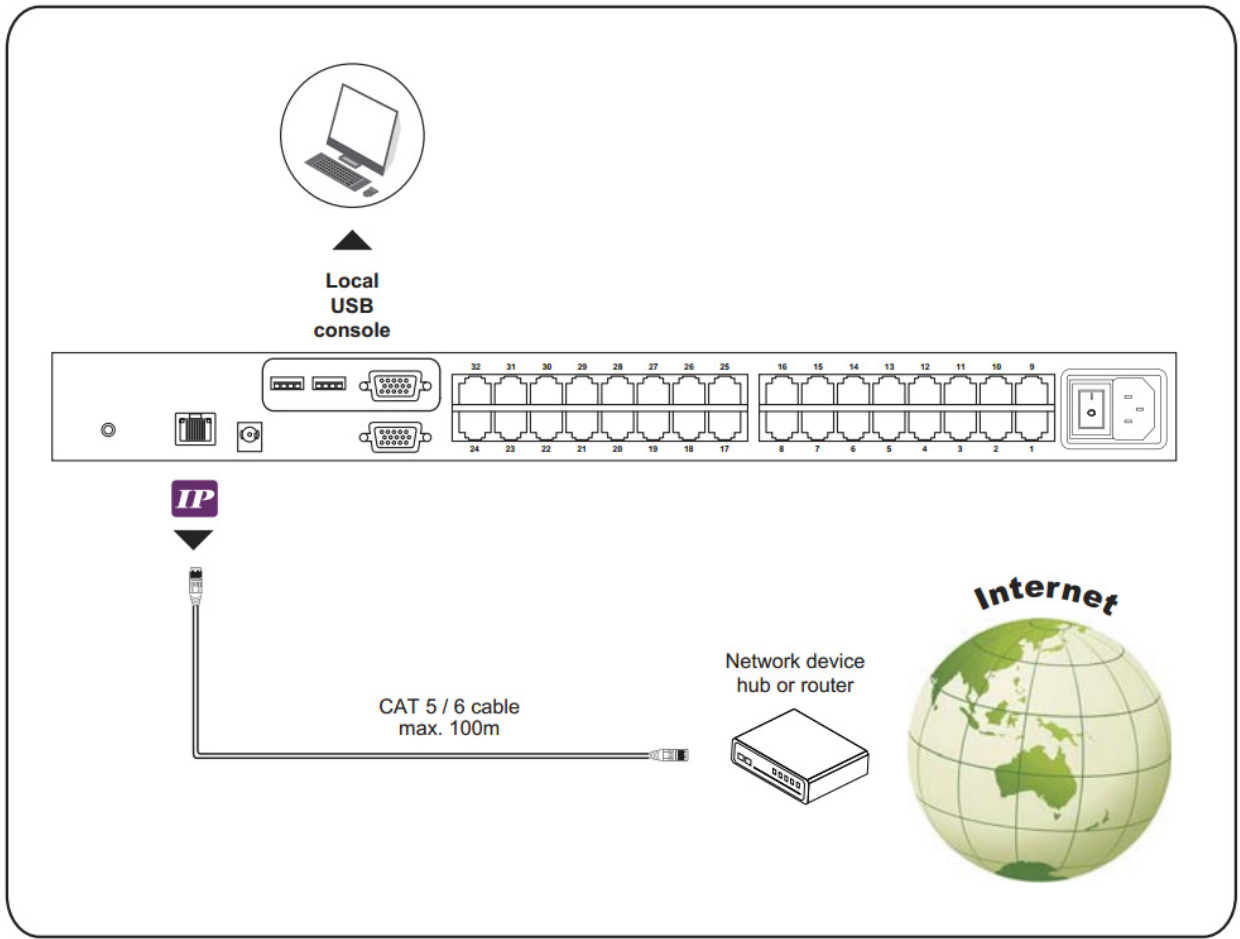

Matrix Cat6 IP KVM Benefits

- Combo Cat6 KVM with either 8, 16 or 32 ports in 1U
- Up to 40 meters between your servers & KVM ports
- IP remote access across the world wide web
- Cascade switches up to 8 levels & Mix switches between Cat6 & Combo DB-15 KVM
- Support DVI-USB, VGA-USB & VGA-PS/2 server interface
- Mix PS/2, USB & SUN with Multi-Platform switch capability

Switch Features & Options

- Multi lingual on screen display menu
- Advanced user profiles and configurable OSD hot key combinations
- Dual power with failover
- 12V, 24V and 48V DC Power options

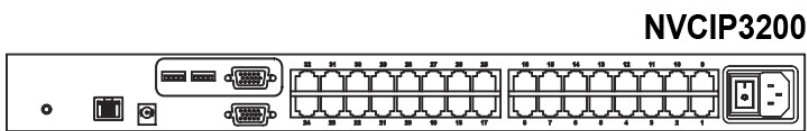
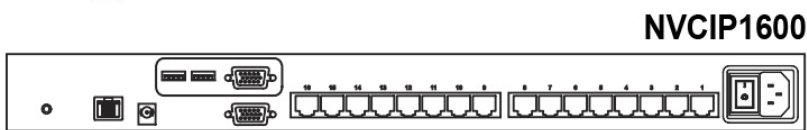
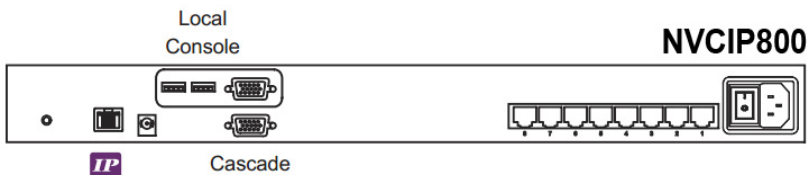

KVM SPECIFICATIONS

■ KVM Port	
Number of ports:	8, 16 or 32
Connector:	RJ-45
Connectivity:	DVI-D / VGA connector dongle up to 40 meters (132 feet) via Cat6 / Cat5 cable
■ Local Console	
Graphic Connector:	1 x DB-15 VGA
Resolution:	Up to 1600 x 1200
Input device:	2 x USB type A for keyboard & mouse
Resolution support:	4:3 - max. 1600 x 1200 16:10 - max. 1440 x 900
■ IP Remote Console	
Connector:	RJ45 Ethernet
User management:	15-user login, 1 x active user
Network protocol:	DHCP / BOOTP / DNS
Security:	SSL v3, RSA, AES, HTTP / HTTPS, CSR
Resolution:	Up to 1600 x 1200
Browser:	IE, Firefox, Safari, Netscape
Resolution support:	4:3 - max. 1600 x 1200
■ Expansion:	Up to 256 servers by 8-level cascade
■ Compatibility	
Multi-platform:	Mix PCs, SUN and Mac G3 / G4 Mac / iMac
Support:	Windows 7 / Vista / 2003 / XP, Linux, Unix

■ Power	
Input:	Auto sensing 100 to 240VAC, 50 / 60 Hz OR AC / DC power adapter 12V@3.3A (optional)
Consumption:	Max. 24 Watt, Standby 5 Watt
■ Regulatory :	
Safety:	cUL, FCC & CE certified
Environment:	RoHS2 & REACH compliant
■ Environmental	
Operating:	0 to 50°C
Storage:	-5 to 60°C
Relative humidity:	90%, non-condensing
Shock:	50G peak acceleration (11ms, half-sine wave)
Vibration:	58-100Hz / 0.98G (11ms / cycle)
■ Product Information	
Dimension (W x D x H):	443 x 171 x 44 mm / 17.4 x 6.7 x 1.73 inch
Net weight:	3 kg / 6.5 lb
■ Packing Information	
Dimension (W x D x H):	500 x 400 x 90 mm / 19.7 x 15.7 x 3.5 inch
Gross weight:	5 kg / 11 lb

KVM CASCADE

- Cascade up to 8 levels, 256 servers
- Cascading multiple KVM with CBC-6 cascade cable

