

CAT6 KVM

NetView: 1U Rackmount 21" Wide 1920 x 1080 LCD KVM with 104 key notepad keyboard w/ Touchpad (e), Integrated with Matrix Cat6, 16 KVM Ports + 1 User Via CAT5 Extender + 1 Users Via KVM over IP. Over Depth is 30 Inch. Dongles sold separately

Model: NVPW1215MC1116e



FEATURES:

- 1U 21" widescreen LCD console drawer
- Support Full HD with 1080p resolution
- 104-key keyboard with touchpad
- New enhanced aesthetics with molded front handle

Drawer Features & Options

- 3G / HD / SD-SDI Broadcast-grade input (w/ speaker)
- HDMI (w/ speaker)
- DC power : 12V / 24V / 48V / 110 ~ 125V

SPECIFICATIONS:

LCD Panel	
Diagonal size	21.5" widescreen TFT
Max. Resolution	1920 x 1080
Brightness (cd/m2)	250
Backlight	LED
Colors	16.7M
Contrast Ratio (typ)	1000 : 1
Viewing Angle (H/V)	170° x 160°
Active area (mm)	477 x 268
MTBF (hrs)	30,000
Casing Color	Black (RAL 9005)
Weight (Single console	
Net	14.7 kgs / 32.3 lbs
Gross	18.9 kgs / 41.6 lbs
Environmental	
Operating	0 to 55°C Degree
Storage	-20 to 60°C Degree
Relative humidity	5-90%, non-condensing
Shock	10G acceleration (11 ms duration)
Vibration	5-500Hz 1G RMS random vibration
Regulatory	FCC & CE certified
Power	
Input	Auto-sensing 100 to 240VAC, 50 / 60Hz
Consumption	Max. 32 Watt, Standby 4 Watt
Product Dimensions (Single console)	
Product	441.6 x 670 x 44 mm / 17.4 x 26.4 x 1.73 inch
Packing	595 x 860 x 140 mm / 23.4 x 33.9 x 5.5 inch

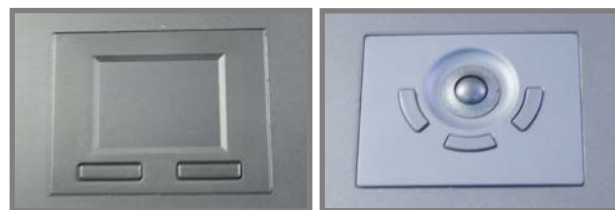



- Hold the handle and slide out the drawer.



- Flip up the LCD to a suitable angle



- Operate the LCD console drawer.



Option - Right Side Open

DIMENSION

Front View



Rear View



Side View



UNIT : mm
1mm = 0.03937 inch

Top View

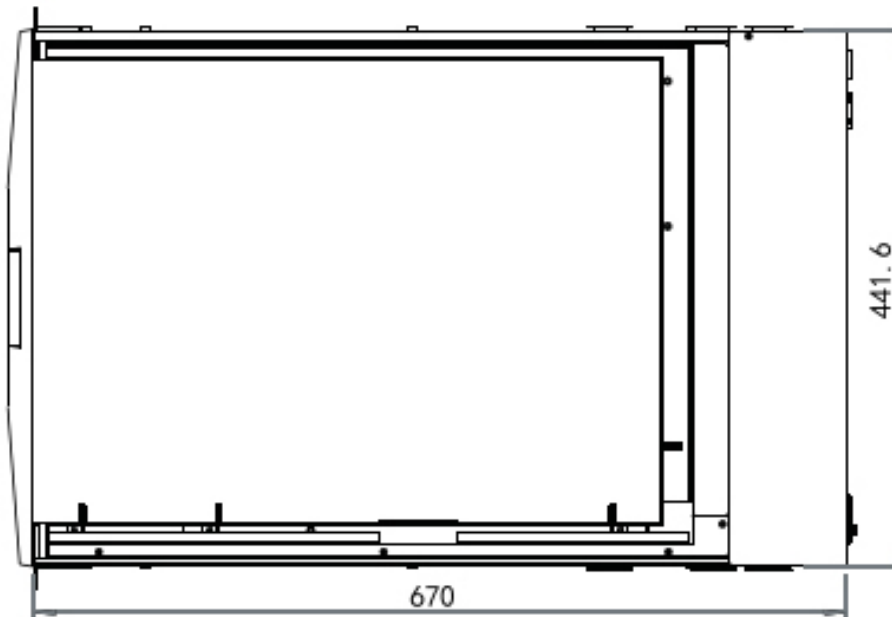

STANDARD KEYBOARD

e keyboard integrated with touchpad

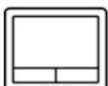

b keyboard integrated with trackball



Supporting layouts

America					
	United States				
EMEA					
	United Kingdom	Germany	France	Spain	Norway
	Italy	Russia	Switzerland	Netherlands	Portugal
Asia	China	Japan	Korea	Arabia	Turkey

STRUCTURE DIAGRAM



KVM PORT & CAT6 DONGLE CONNECTION

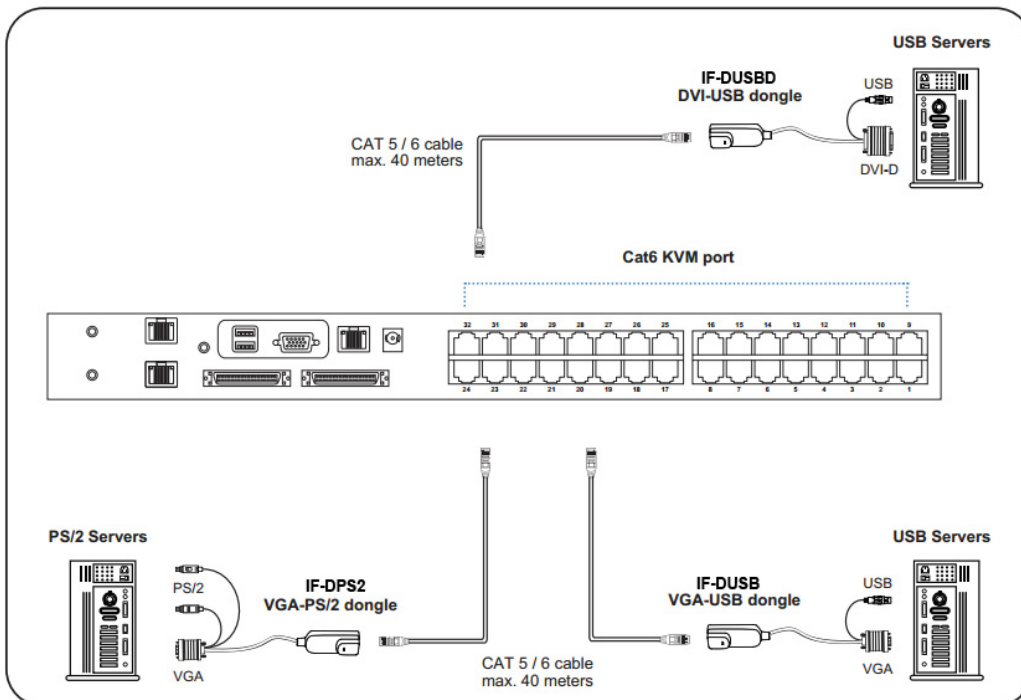

IF-DUSBD DVI-USB dongle

- To connect DVI-D connector to the computer's video card
- To connect USB connector to the computer's USB port



IF-DUSB VGA-USB dongle

- To connect DB-15 connector to the computer's video card
- To connect USB connector to the computer's USB port



IF-DPS2 VGA-PS/2 dongle

- To connect DB-15 connector to the computer's video card
- To connect PS/2 keyboard connector to the computer's keyboard port
- To connect PS/2 mouse connector to the computer's mouse port

Cat6 Dongle	EDID Resolution Hard-coded	Resolutions Capable			
		4:3			16:10
		1024 x 768	1280 x 1024	1600 x 1200	1440 x 900
IF-DPS2	1600 x 1200	✓	✓	✓	✓*
IF-DUSB	1600 x 1200	✓	✓	✓	✓*
IF-DUSBD	1280 x 1024	✓	✓	✗	✗

* Requires the user to enable showing unsupported resolutions via the target computer's video adapter settings (effectively ignoring the DDC / EDID)

IP, REMOTE & LOCAL CONSOLE CONNECTION

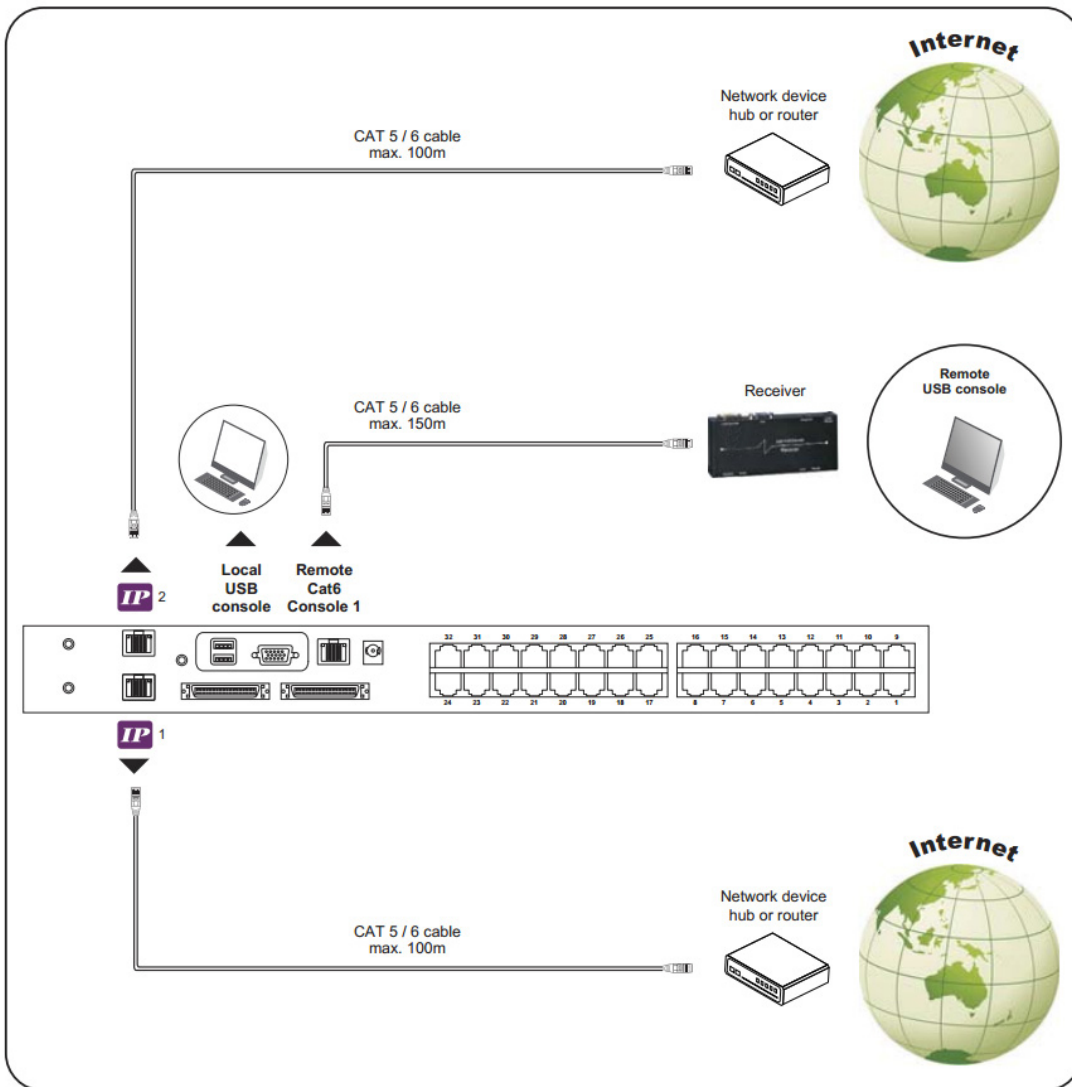

Matrix Cat6 IP KVM Benefits

- Secure IP remote user access across the world wide web
- Efficient system management with simultaneous multi-user access
- Capable of connecting 32 or 16 servers per device in 1U
- Support DVI-USB, VGA-USB & VGA-PS/2 server interface
- Up to 40 meters between your server & KVM switch
- Enhanced Cat6 cable management with remote access up to 150m

Switch Features & Options

- Provide a diversity of console to access servers independently and simultaneously
- Use of the RJ45 Cat6 interface allows for a higher number of ports in smaller density
- Greater distances between your switch and servers allow enhanced data center rack layouts
- Multi lingual on screen display menu
- Advanced user profiles and configurable OSD hot key combinations

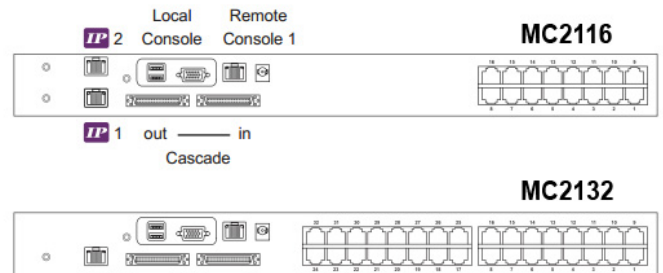
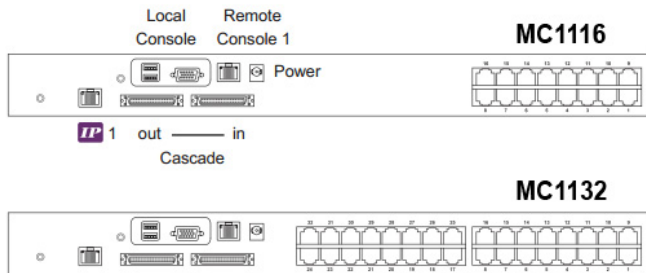

KVM SPECIFICATIONS

■ KVM Port	
Number of ports:	16 or 32
Connector:	RJ-45
Connectivity:	DVI-D / VGA connector dongle up to 40 meters (132 feet) via Cat6 / Cat5 cable
■ Local Console	
Monitor port:	DB15-pin VGA
Keyboard & mouse port:	2 x USB type connector for keyboard & mouse
Resolution support:	4:3 - max. 1600x1200 16:10 - max. 1440x900
■ Cat6 Remote Console	
Number of remote port:	1
Monitor port:	DB15-pin VGA
Keyboard & mouse port:	2 x USB type connector for keyboard & mouse
Remote I/O:	RJ45 via Cat5 / Cat5e / Cat6 cable up to 500 feet
Resolution support:	4:3 -max. 1600x1200 16:10-max. 1440x900
■ IP Remote Console	
Number of IP console:	1 for MC1116 / MC1132 2 for MC2116 / MC2132
User management:	15-user login, 1 x active user
Browser:	Internet Explorer, Firefox, Safari
Security:	SSL v3, RSA, AES, HTTP / HTTPS, CSR
IP Access:	RJ45 Ethernet per IP console
Resolution support:	4:3-max. 1600x1200

■ Expansion:	Up to 256 servers by 8-level cascade
■ Compatibility:	
Multi-platform:	Mix PCs, SUN and Mac G3 / G4 Mac / iMac
Support:	Windows 7 / Vista / 2003 / XP, Linux, Unix
■ Power	
Input:	AC power adapter
Consumption:	Max. 48 Watt, Standby 5 Watt
■ Regulatory :	
Safety:	cUL, FCC & CE certified
Environment:	RoHS2 & REACH compliant
■ Environmental	
Operating:	0 to 50°C
Storage:	-5 to 60°C
Relative humidity:	90%, non-condensing
Shock:	50G peak acceleration (11ms, half-sine)
Vibration:	58-100Hz / 0.98G (11ms / cycle)
■ Product Information	
Dimension (W x D x H):	443 x 171 x 44 mm / 17.4 x 6.7 x 1.73 inch
Net weight:	3 kg / 6.5 lb
■ Packing Information	
Dimension (W x D x H):	500 x400 x90 mm / 19.7 x 15.7x3.5 inch
Gross weight:	5 kg / 11 lb

KVM CASCADE

- Cascade up to 8 levels, 256 servers
- Cascading multiple KVM with CMC-8 cascade cable



CMC-8

- 8ft Matrix KVM cascade cable