

NetView: 1U Rackmount 21" Wide 1920 x 1080 LCD KVM with 104 key notepad MAC keyboard w/ Trackball (b), Integrated with DVI-D + keyboard + mouse, 1 KVM Ports + 0 User Via CAT5 Extender + 0 Users Via KVM over IP. Over Depth is Inch. Dongles sold separately

Model: NVPW1215Mb

#### FEATURES:

- 1U 21" widescreen LCD console drawer
- Support Full HD with 1080p resolution
- 104-key MAC keyboard with trackball
- New enhanced aesthetics with molded front handle

#### Drawer Features & Options

- 3G / HD / SD-SDI Broadcast-grade input (w/ speaker)
- HDMI (w/ speaker)
- DC power : 12V / 24V / 48V / 110 ~ 125V

#### SPECIFICATIONS:

LCD Panel	
Diagonal size	21.5" widescreen TFT
Max. Resolution	1920 x 1080
Brightness (cd/m <sup>2</sup> )	250
Backlight	LED
Colors	16.7M
Contrast Ratio (typ)	1000 : 1
Viewing Angle (H/V)	170° x 160°
Active area (mm)	477 x 268
MTBF (hrs)	30,000
Casing Color	Black ( RAL 9005 )
Weight ( Single console	
Net	14.7 kgs / 32.3 lbs
Gross	18.9 kgs / 41.6 lbs
Environmental	
Operating	0 to 55°C Degree
Storage	-20 to 60°C Degree
Relative humidity	5-90%, non-condensing
Shock	10G acceleration ( 11 ms duration )
Vibration	5-500Hz 1G RMS random vibration
Regulatory	FCC & CE certified
Power	
Input	Auto-sensing 100 to 240VAC, 50 / 60Hz
Consumption	Max. 32 Watt, Standby 4 Watt
Product Dimensions ( Single console )	
Product	441.6 x 670 x 44 mm / 17.4 x 26.4 x 1.73 inch
Packing	595 x 860 x 140 mm / 23.4 x 33.9 x 5.5 inch

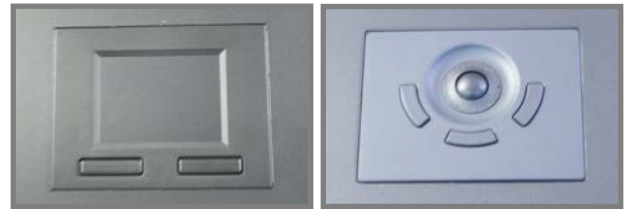

## MAC Keyboard / Mouse Options

**Me** MAC keyboard integrated with touchpad



**Mb** MAC keyboard integrated with trackball



### Supporting layouts

America



United States

## How to Use "MAC" Keyboard

### Keyboard Features



**F1**  
Decrease display brightness



**F9**  
Fast-forward



**F2**  
Increase display brightness



**F10**  
Mute sound



**F3**  
Mission control  
\* Only works with OS X Lion  
default Keyboard Shortcuts.



**F11**  
Decrease volume



**F4**  
Dashboard



**F12**  
Increase volume



**F7**  
Rewind



Eject disc



**F8**  
Play / Pause



Command

## STRUCTURE DIAGRAM

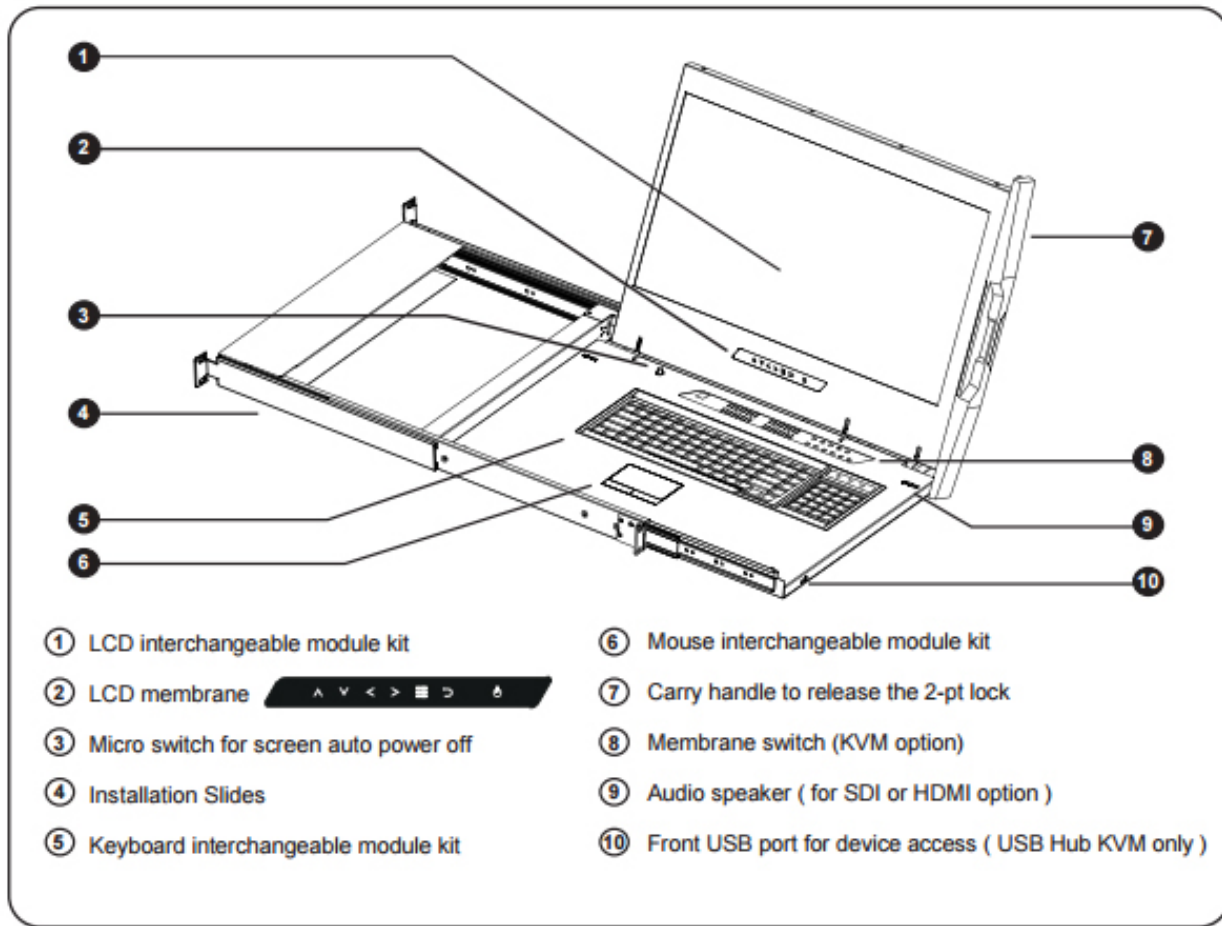

## STANDARD KEYBOARD



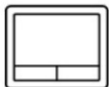
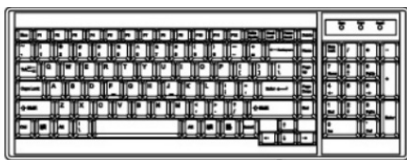











e keyboard integrated with touchpad



b keyboard integrated with trackball



### Supporting layouts

America		United States			
EMEA					
	United Kingdom	Germany	France	Spain	Norway
					
	Italy	Russia	Switzerland	Netherlands	Portugal
	Asia				
	China	Japan	Korea	Arabia	Turkey



- Hold the handle and slide out the drawer.



- Flip up the LCD to a suitable angle



- Operate the LCD console drawer.

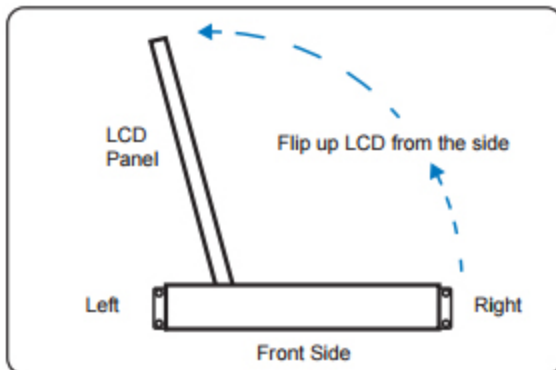

**Option - Right Side Open**

## DIMENSION

Front View

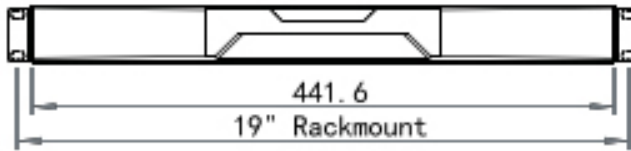

Rear View



Side View



UNIT : mm  
1mm = 0.03937 inch

Top View

