



NetView:1U Rackmount 24" Wide 1920 x 1200 LCD KVM with 104 key notepad Sun Compatible Keyboard w/ Touchpad (e), Integrated with DVI-D,12 KVM Ports + 0 User Via CAT5 Extender + 0 Users Via KVM over IP. Over Depth is 31.5 Inch. Dongles sold separately

Model: NVPW1240-12DSe

FEATURES:

- 1U 24" widescreen LCD console drawer
- Support 1920 x 1200 native WUXGA Ultra high resolution
- 104-key notepad SUN Compatible keyboard with touchpad
- New enhanced aesthetics with molded front handle
- 12-port DVI-D, USB & Audio KVM

Drawer Features & Options

- 3G / HD / SD-SDI Broadcast-grade input (w/ speaker)
- HDMI (w/ speaker)
- DC power : 12V / 24V / 48V / 110 ~ 125V

SPECIFICATIONS:

LCD Panel	
Diagonal size	24.1" widescreen TFT
Max. Resolution	1920 x 1200
Brightness (cd/m2)	300
Backlight	LED
Colors	16.7M
Contrast Ratio (typ)	1000 : 1
Viewing Angle (H/V)	178° x 178°
Active area (mm)	518 x 324
MTBF (hrs)	30,000
Casing Color	Black (RAL 9005)
Weight (Single console	
Net	15.3 kgs / 33.7 lbs
Gross	19.5 kgs / 42.9 lbs
Environmental	
Operating	0 to 55°C Degree
Storage	-20 to 60°C Degree
Relative humidity	5-90%, non-condensing
Shock	10G acceleration (11 ms duration)
Vibration	5-500Hz 1G RMS random vibration
Regulatory	FCC & CE certified
Power	
Input	Auto-sensing 100 to 240VAC, 50 / 60Hz
Consumption	Max. 40 Watt, Standby 5 Watt
Product Dimensions (Single console)	
Product	441.6 x 700 x 44 mm / 17.4 x 27.6 x 1.73 inch
Packing	595 x 910 x 140 mm / 23.4 x 35.8 x 5.5 inch



SUN Keyboard / Mouse Options

Se

SUN keyboard integrated with touchpad



Sb

SUN keyboard integrated with trackball



SUN keyboard integrated with touchpad/trackball

- Incorporates SUN keys, including Stop, Cut, Paste, Compose, Copy and Help
- 104 key notepad keyboard with full numerical pad and SUN function
- USB interface
- US layout only

How to Use "SUN" Keyboard



Num LED in Off mode

Key pad behaves as a SUN Solar system administration command mode



Num LED in Green mode

Key pad behaves as a normal key pad mode

Audio / Display Keys

* Please ask your supplier for full details



F9
Audio : Mute
Display : Degauss



F11
Audio : Decrease volume
Display : Decrease contrast



F12
Audio : Increase volume
Display : Increase contrast



- Hold the handle and slide out the drawer.



- Flip up the LCD to a suitable angle



- Operate the LCD console drawer.



Option - Right Side Open

DIMENSION

Front View



Rear View



UNIT : mm
1mm = 0.03937 inch

Side View



Top View



STANDARD KEYBOARD

















e keyboard integrated with touchpad



b keyboard integrated with trackball



Supporting layouts

America	 United States				
EMEA	 United Kingdom	 Germany	 France	 Spain	 Norway
	 Italy	 Russia	 Switzerland	 Netherlands	 Portugal
Asia	 China	 Japan	 Korea	 Arabia	 Turkey

STRUCTURE DIAGRAM

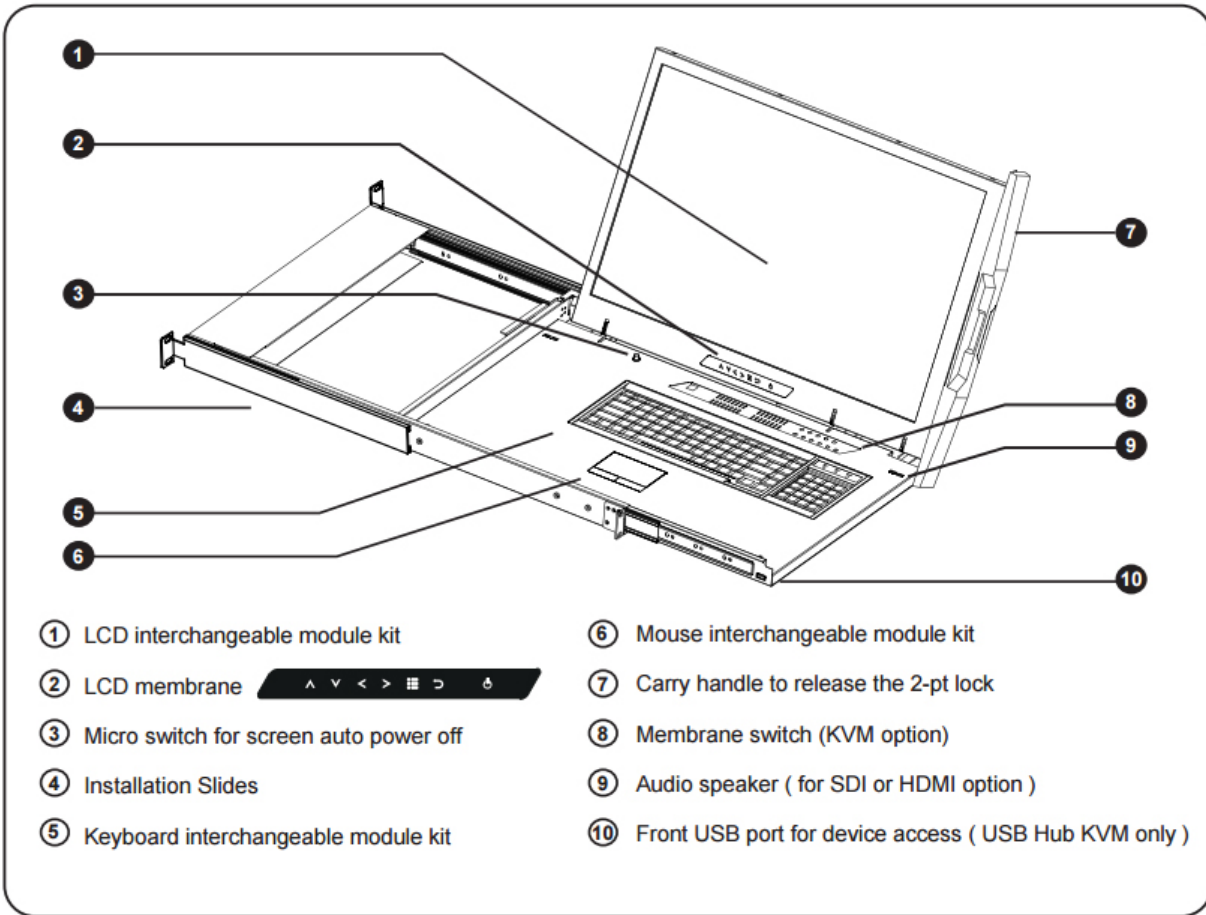

KVM PORT CONNECTION

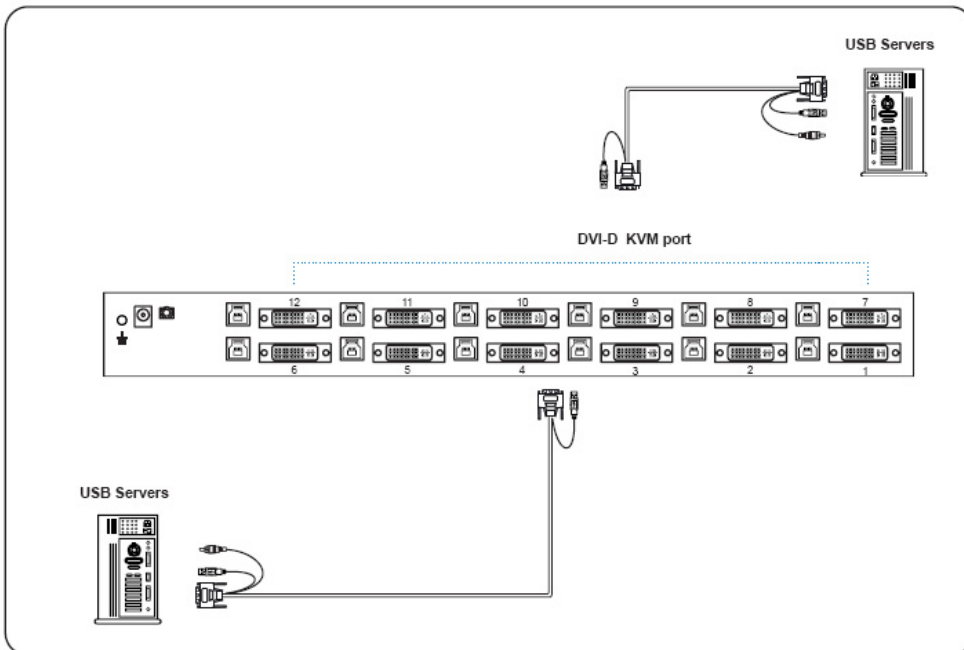

DVI KVM Cable

NC-6: 6 feet DVI KVM Cable

NC-15: 6 feet DVI KVM Cable

(Server end : DVI-D+USB+Audio)

(KVM Port: DVI-D+USB 3.0)



DVI KVM SPECIFICATIONS

KVM Port	
Number of ports:	12
Connector:	DVI-D connector
	USB 3.0 connector (combined for keyboard, mouse & audio)
Connectivity:	Combo 4-in-1 KVM cable, 6 or 15 feet
Local Console	
Graphic connector:	1 x DVI-D
Resolution:	Up to 1920x1200
Input device:	2 x USB type A for keyboard & mouse
Audio out:	1 x 3.5mm stereo audio
Management	
PC Selection:	Front button & keyboard hotkey
Compatibility	
Multi-platform:	Mix PCs, SUN and Mac G3 / G4 Mac / iMac
Support:	Windows 7 / Vista / 2003 / XP, Linux, Unix

Regulatory	
Safety:	FCC & CE certified
Environment:	RoHS2 & REACH compliant
Environmental	
Operating:	0 to 50°C
Storage:	-5 to 60°C
Relative humidity:	90%, non-condensing
Shock:	50G peak acceleration (11ms, half-sine wave)
Vibration:	58-100Hz/0.98G (11ms/ cycle)

Front Panel - Port LED Indications

DVI-D KVM 12 ports

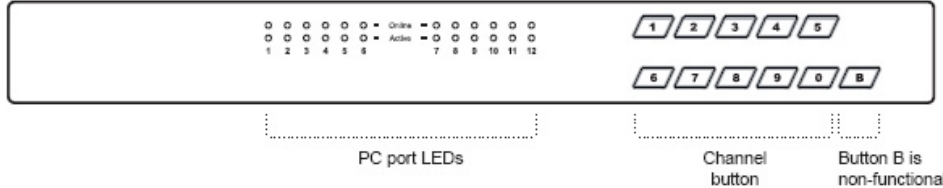

PC port LEDs	Online : Blue LED on indicating a PC is connecting to the port Active : Green LED on indicating a selected channel
Channel button	Press to select channel from 01 to 12