

DB-15 KVM

NetView: 1U Rackmount 24" Wide 1920 x 1200 LCD KVM with 104 key notepad MAC keyboard w/ Trackball (b), Integrated with Matrix DB-15, 16 KVM Ports + 2 User Via CAT5 Extender + 0 Users Via KVM over IP. Over Depth is 31.5 Inch. Dongles sold separately

Model: NVPW1240M0216Mb



FEATURES:

- 1U 24" widescreen LCD console drawer
- Support 1920 x 1200 native WUXGA Ultra high resolution
- PIP & Picture by Picture viewing efficiency
- 104-key keyboard with trackball
- New enhanced aesthetics with molded front handle

Drawer Features & Options

- 3G / HD / SD-SDI Broadcast-grade input (w/ speaker)
- HDMI (w/ speaker)
- DC power : 12V / 24V / 48V / 110 ~ 125V

SPECIFICATIONS:

|                                       |   |
|---------------------------------------|---|
| LCD Panel                             |   |
| Diagonal size                         | 24.1" widescreen TFT                          |
| Max. Resolution                       | 1920 x 1200                                   |
| Brightness (cd/m2)                    | 300   |
| Backlight                             | LED   |
| Colors                                | 16.7M   |
| Contrast Ratio (typ)                  | 1000 : 1                                      |
| Viewing Angle (H/V)                   | 178° x 178°                                   |
| Active area (mm)                      | 518 x 324                                     |
| MTBF (hrs)                            | 30,000  |
| Casing Color                          | Black ( RAL 9005 )                            |
| Weight ( Single console               |   |
| Net                                   | 15.3 kgs / 33.7 lbs                           |
| Gross                                 | 19.5 kgs / 42.9 lbs                           |
| Environmental                         |   |
| Operating                             | 0 to 55°C Degree                              |
| Storage                               | -20 to 60°C Degree                            |
| Relative humidity                     | 5~90%, non-condensing                         |
| Shock                                 | 10G acceleration ( 11 ms duration )           |
| Vibration                             | 5~500Hz 1G RMS random vibration               |
| Regulatory                            | FCC & CE certified                            |
| Power                                 |   |
| Input                                 | Auto-sensing 100 to 240VAC, 50 / 60Hz         |
| Consumption                           | Max. 40 Watt, Standby 5 Watt                  |
| Product Dimensions ( Single console ) |   |
| Product                               | 441.6 x 700 x 44 mm / 17.4 x 27.6 x 1.73 inch |
| Packing                               | 595 x 910 x 140 mm / 23.4 x 35.8 x 5.5 inch   |

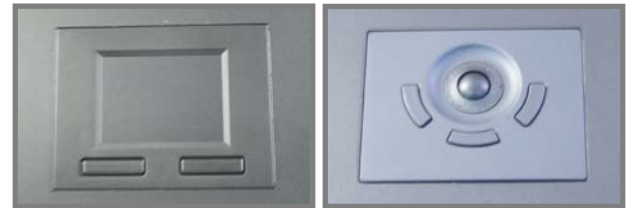

## MAC Keyboard / Mouse Options

**Me** MAC keyboard integrated with touchpad



**Mb** MAC keyboard integrated with trackball



### Supporting layouts

America



United States

## How to Use "MAC" Keyboard

### Keyboard Features



**F1**  
Decrease display brightness



**F9**  
Fast-forward



**F2**  
Increase display brightness



**F10**  
Mute sound



**F3**  
Mission control  
\* Only works with OS X Lion  
default Keyboard Shortcuts.



**F11**  
Decrease volume



**F4**  
Dashboard



**F12**  
Increase volume



**F7**  
Rewind



Eject disc



**F8**  
Play / Pause



Command



- Hold the handle and slide out the drawer.



- Flip up the LCD to a suitable angle



- Operate the LCD console drawer.



**Option - Right Side Open**

## DIMENSION

Front View



Rear View



UNIT : mm  
1mm = 0.03937 inch

Side View



Top View



## STANDARD KEYBOARD

















e keyboard integrated with touchpad



b keyboard integrated with trackball



### Supporting layouts

|         |  |   |   |   |  |
|---------|--|---|---|---|--|
| America | <br>United States |   |   |   |  |
| EMEA    |  United Kingdom   |  Germany |  France      |  Spain       |  Norway   |
|         |  Italy            |  Russia  |  Switzerland |  Netherlands |  Portugal |
| Asia    |  China            |  Japan   |  Korea       |  Arabia      |  Turkey   |

## STRUCTURE DIAGRAM

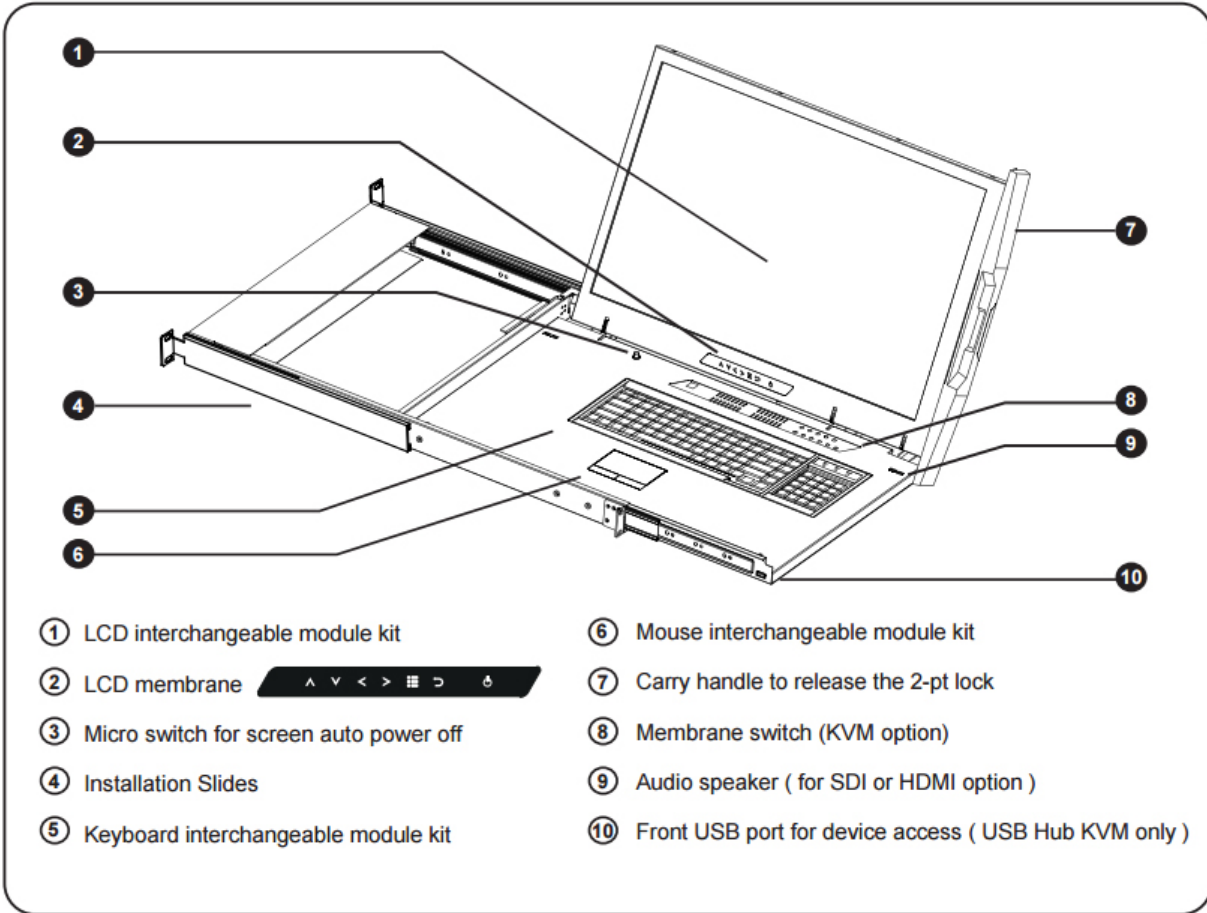

## KVM PORT CONNECTION



**NE-6 / NE-10 / NE-15**  
 ■ 6 / 10 / 15 ft Combo KVM cable  
 ■ Support PS/2 or USB server



## Matrix DB-15 KVM Benefits

- Efficient system management with simultaneous multi-user access
- Support resolution up to 1920 x 1080
- SUN 1152 x 900 resolution compatible
- Multi-platform servers shared by different consoles in cascade connection
- Mix PS/2, USB & SUN with Multi-Platform switch capability Extended Cat6 cord remote access up to 150 meters
- Provide a diversity of consoles to access servers independently & simultaneously

## Switch Features & Options

- Greater distances between your switch and servers allow enhanced data center rack layouts
- Multi lingual on screen display menu
- Advanced user profiles and configurable OSD hot key combinations

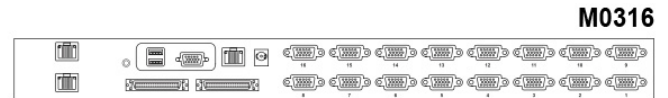
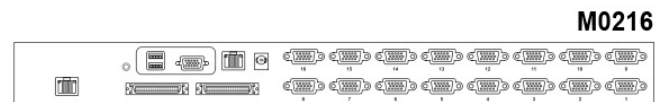
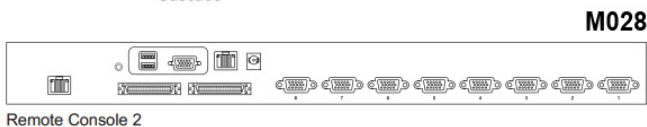
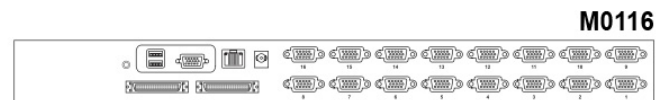

## KVM SPECIFICATIONS

|                              |  |
|------------------------------|--|
| <b>■ KVM Port</b>            |  |
| Number of ports:             | 8 or 16  |
| Connector:                   | DB-15 combo connector  |
| Connectivity:                | Combo 4-in-1 KVM cable up to 6, 10 & 15 feet                   |
| <b>■ Local Console</b>       |  |
| Monitor port:                | 1 x DB-15 VGA (Up to 1920 x 1080 /1920 x 1200)                 |
| Keyboard & mouse port:       | 2 x USB type connector for keyboard & mouse                    |
| <b>■ CAT6 Remote Console</b> |  |
| Number of remote port:       | 1 for M018 / M0116<br>2 for M028 / M0216<br>3 for M038 / M0316 |
| Monitor port:                | DB15-pin VGA (Up to 1600 x 1200)                               |
| Keyboard & mouse port:       | 2 x USB type connector for keyboard & mouse                    |
| Remote I/O:                  | RJ45 via Cat5 / Cat5e / Cat6 cable up to 500 feet              |
| <b>■ Expansion</b>           | Up to 256 servers by 8-level cascade                           |
| <b>■ Compatibility</b>       |  |
| Multi-platform:              | Mix PCs, SUN and Mac G3 / G4 Mac / iMac                        |
| Support:                     | Windows 7 / Vista / 2003 / XP, Linux, Unix                     |

|                              |  |
|------------------------------|--|
| <b>■ Power</b>               |  |
| Input:                       | AC power adapter                             |
| Consumption:                 | Max. 48 Watt, Standby 5 Watt                 |
| <b>■ Regulatory :</b>        |  |
| Safety:                      | cUL, FCC & CE certified                      |
| Environment:                 | RoHS2 & REACH compliant                      |
| <b>■ Environmental</b>       |  |
| Operating:                   | 0 to 50°C                                    |
| Storage:                     | -5 to 60°C                                   |
| Relative humidity:           | 90%, non-condensing                          |
| Shock:                       | 50G peak acceleration (11ms, half-sine wave) |
| Vibration:                   | 58-100Hz / 0.98G (11ms / cycle)              |
| <b>■ Product Information</b> |  |
| Dimension (W x D x H):       | 443 x 171 x 44 mm / 17.4 x 6.7 x 1.73 inch   |
| Net weight:                  | 3 kg / 6.5 lb                                |
| <b>■ Packing Information</b> |  |
| Dimension (W x D x H):       | 500 x 400 x 90 mm / 19.7 x 15.7 x 3.5 inch   |
| Gross weight:                | 5 kg / 11 lb                                 |

# REMOTE & LOCAL CONSOLE CONNECTION



## KVM CASCADE

- Cascade up to 8 levels, 240 servers
- Cascading multiple KVM with CMC-8 cascade cable

### Master KVM



out — in  
Cascade

To cascade IN port



Cascaded KVMs from level 2 to 8 must be the models of M018 / M0116 or MC0116 / MC0132.



When multiple matrix KVMs cascade together, the master KVM at level 1 will take all control of other slave KVM switches (e.g. level 2 to 8).



The slave matrix KVM will be as a port expansion module of the master matrix KVM, the original remote console on slave KVM will be sacrificed and disabled.



### CMC-8

- 8ft Matrix KVM cascade cable