

**DB-15 KVM**

NetView:1U Rackmount 24" Wide 1920 x 1200 LCD KVM with 104 key notepad keyboard w/ Trackball ( b ), Integrated with Matrix DB-15,8 KVM Ports + 2 User Via CAT5 Extender + 0 Users Via KVM over IP. Over Depth is 31.5 Inch. Dongles sold separately

**Model: NVPW1240M028b**



**FEATURES:**

- 1U 24" widescreen LCD console drawer
- Support 1920 x 1200 native WUXGA Ultra high resolution
- PIP & Picture by Picture viewing efficiency
- 104-key keyboard with trackball
- New enhanced aesthetics with molded front handle

**Drawer Features & Options**

- 3G / HD / SD-SDI Broadcast-grade input (w/ speaker)
- HDMI (w/ speaker)
- DC power : 12V / 24V / 48V / 110 ~ 125V

**SPECIFICATIONS:**

LCD Panel	
Diagonal size	24.1" widescreen TFT
Max. Resolution	1920 x 1200
Brightness (cd/m2)	300
Backlight	LED
Colors	16.7M
Contrast Ratio (typ)	1000 : 1
Viewing Angle (H/V)	178° x 178°
Active area (mm)	518 x 324
MTBF (hrs)	30,000
Casing Color	Black ( RAL 9005 )
Weight ( Single console	
Net	15.3 kgs / 33.7 lbs
Gross	19.5 kgs / 42.9 lbs
Environmental	
Operating	0 to 55°C Degree
Storage	-20 to 60°C Degree
Relative humidity	5~90%, non-condensing
Shock	10G acceleration ( 11 ms duration )
Vibration	5~500Hz 1G RMS random vibration
Regulatory	FCC & CE certified
Power	
Input	Auto-sensing 100 to 240VAC, 50 / 60Hz
Consumption	Max. 40 Watt, Standby 5 Watt
Product Dimensions ( Single console )	
Product	441.6 x 700 x 44 mm / 17.4 x 27.6 x 1.73 inch
Packing	595 x 910 x 140 mm / 23.4 x 35.8 x 5.5 inch

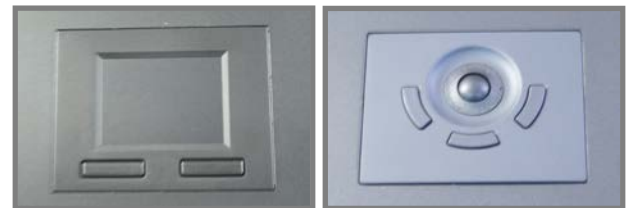



- Hold the handle and slide out the drawer.



- Flip up the LCD to a suitable angle



- Operate the LCD console drawer.



**Option - Right Side Open**

## DIMENSION

Front View



Rear View



UNIT : mm  
1mm = 0.03937 inch

Side View



Top View

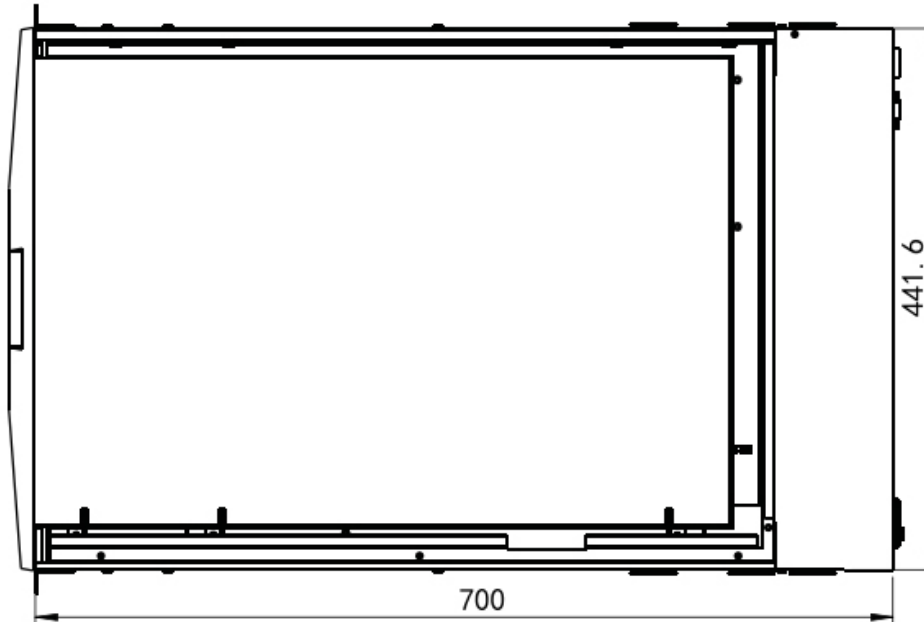

## STANDARD KEYBOARD

e keyboard integrated with touchpad



b keyboard integrated with trackball



### Supporting layouts

America	 United States				
EMEA	 United Kingdom	 Germany	 France	 Spain	 Norway
	 Italy	 Russia	 Switzerland	 Netherlands	 Portugal
Asia	 China	 Japan	 Korea	 Arabia	 Turkey

## STRUCTURE DIAGRAM

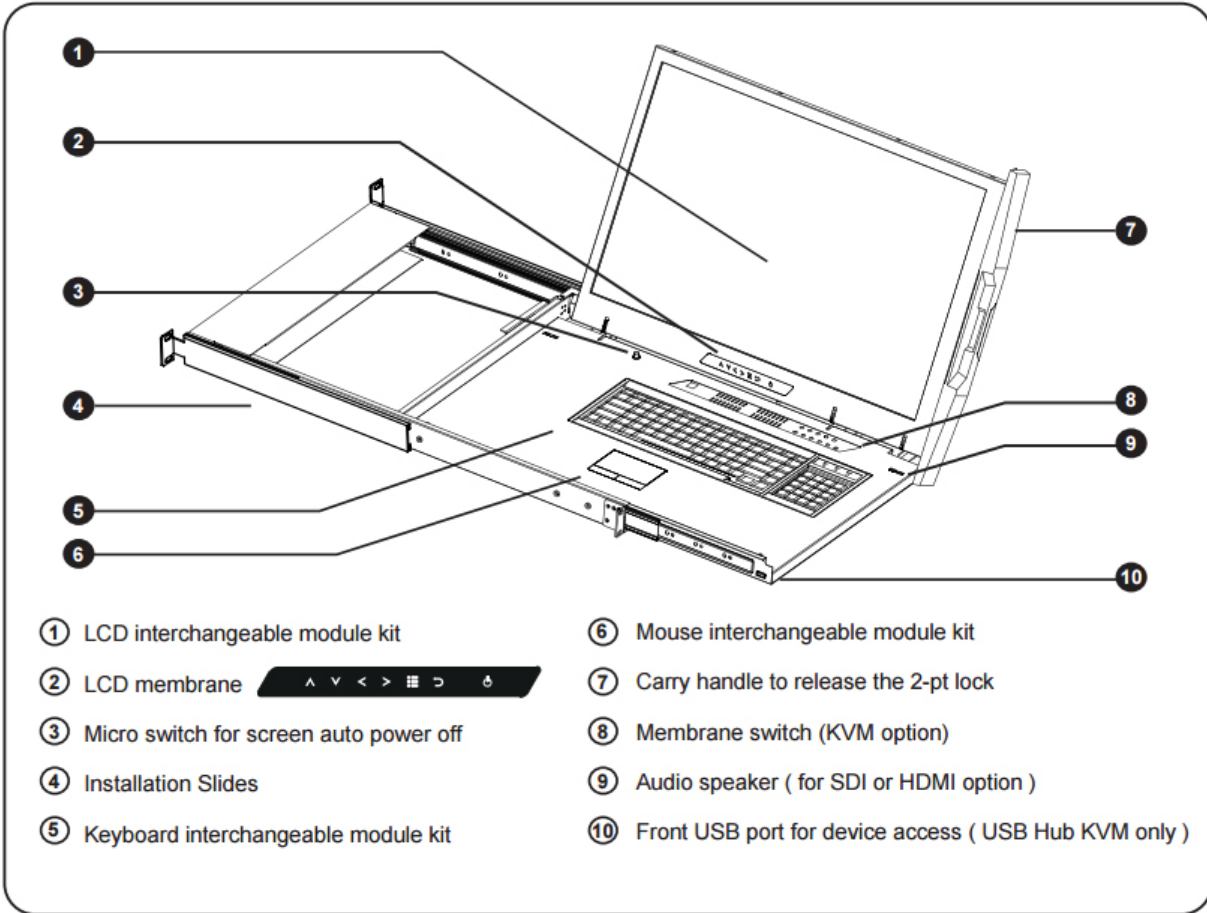

## KVM PORT CONNECTION



**NE-6 / NE-10 / NE-15**  
 ■ 6 / 10 / 15 ft Combo KVM cable  
 ■ Support PS/2 or USB server

## Matrix DB-15 KVM Benefits

- Efficient system management with simultaneous multi-user access
- Support resolution up to 1920 x 1080
- SUN 1152 x 900 resolution compatible
- Multi-platform servers shared by different consoles in cascade connection
- Mix PS/2, USB & SUN with Multi-Platform switch capability Extended Cat6 cord remote access up to 150 meters
- Provide a diversity of consoles to access servers independently & simultaneously

## Switch Features & Options

- Greater distances between your switch and servers allow enhanced data center rack layouts
- Multi lingual on screen display menu
- Advanced user profiles and configurable OSD hot key combinations

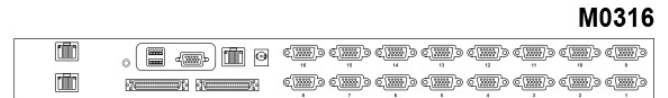
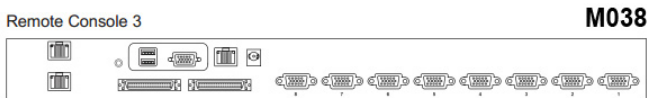
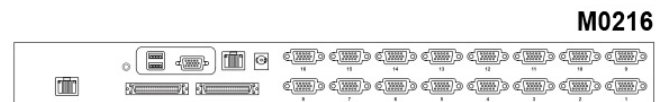
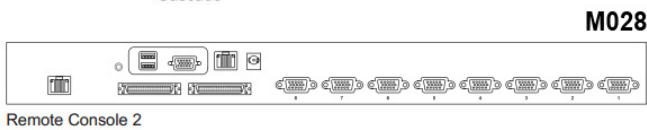
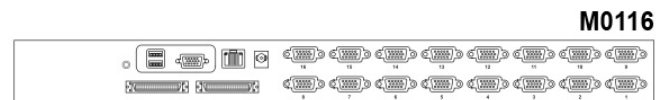

## KVM SPECIFICATIONS

<b>■ KVM Port</b>	
Number of ports:	8 or 16
Connector:	DB-15 combo connector
Connectivity:	Combo 4-in-1 KVM cable up to 6, 10 & 15 feet
<b>■ Local Console</b>	
Monitor port:	1 x DB-15 VGA (Up to 1920 x 1080 /1920 x 1200)
Keyboard & mouse port:	2 x USB type connector for keyboard & mouse
<b>■ CAT6 Remote Console</b>	
Number of remote port:	1 for M018 / M0116 2 for M028 / M0216 3 for M038 / M0316
Monitor port:	DB15-pin VGA (Up to 1600 x 1200)
Keyboard & mouse port:	2 x USB type connector for keyboard & mouse
Remote I/O:	RJ45 via Cat5 / Cat5e / Cat6 cable up to 500 feet
<b>■ Expansion</b>	Up to 256 servers by 8-level cascade
<b>■ Compatibility</b>	
Multi-platform:	Mix PCs, SUN and Mac G3 / G4 Mac / iMac
Support:	Windows 7 / Vista / 2003 / XP, Linux, Unix

<b>■ Power</b>	
Input:	AC power adapter
Consumption:	Max. 48 Watt, Standby 5 Watt
<b>■ Regulatory :</b>	
Safety:	cUL, FCC & CE certified
Environment:	RoHS2 & REACH compliant
<b>■ Environmental</b>	
Operating:	0 to 50°C
Storage:	-5 to 60°C
Relative humidity:	90%, non-condensing
Shock:	50G peak acceleration (11ms, half-sine wave)
Vibration:	58-100Hz / 0.98G (11ms / cycle)
<b>■ Product Information</b>	
Dimension (W x D x H):	443 x 171 x 44 mm / 17.4 x 6.7 x 1.73 inch
Net weight:	3 kg / 6.5 lb
<b>■ Packing Information</b>	
Dimension (W x D x H):	500 x 400 x 90 mm / 19.7 x 15.7 x 3.5 inch
Gross weight:	5 kg / 11 lb



# REMOTE & LOCAL CONSOLE CONNECTION



## KVM CASCADE

- Cascade up to 8 levels, 240 servers
- Cascading multiple KVM with CMC-8 cascade cable

### Master KVM

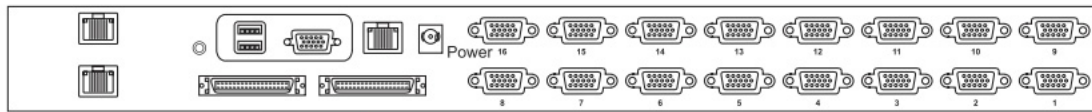

out — in  
Cascade

To cascade IN port

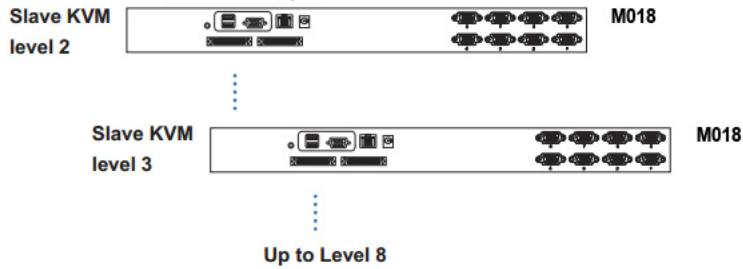

Cascaded KVMs from level 2 to 8 must be the models of M018 / M0116 or MC0116 / MC0132.



When multiple matrix KVMs cascade together, the master KVM at level 1 will take all control of other slave KVM switches (e.g. level 2 to 8).



The slave matrix KVM will be as a port expansion module of the master matrix KVM, the original remote console on slave KVM will be sacrificed and disabled.



### CMC-8

- 8ft Matrix KVM cascade cable