

DB-15 KVM

NetView:1U Rackmount 24" Wide 1920 x 1200 LCD KVM with 104 key notepad Sun Compatible Keyboard w/ Trackball (b), Integrated with Matrix DB-15,16 KVM Ports + 3 User Via CAT5 Extender + 0 Users Via KVM over IP. Over Depth is 31.5 Inch. Dongles sold separately

Model: NVPW1240M0316Sb

FEATURES:

- 1U 24" widescreen LCD console drawer
- Support 1920 x 1200 native WUXGA Ultra high resolution
- PIP & Picture by Picture viewing efficiency
- 104-key notepad SUN Compatible keyboard with trackball
- New enhanced aesthetics with molded front handle

Drawer Features & Options

- 3G / HD / SD-SDI Broadcast-grade input (w/ speaker)
- HDMI (w/ speaker)
- DC power : 12V / 24V / 48V / 110 ~ 125V

SPECIFICATIONS:

LCD Panel	
Diagonal size	24.1" widescreen TFT
Max. Resolution	1920 x 1200
Brightness (cd/m2)	300
Backlight	LED
Colors	16.7M
Contrast Ratio (typ)	1000 : 1
Viewing Angle (H/V)	178° x 178°
Active area (mm)	518 x 324
MTBF (hrs)	30,000
Casing Color	Black (RAL 9005)
Weight (Single console	
Net	15.3 kgs / 33.7 lbs
Gross	19.5 kgs / 42.9 lbs
Environmental	
Operating	0 to 55°C Degree
Storage	-20 to 60°C Degree
Relative humidity	5-90%, non-condensing
Shock	10G acceleration (11 ms duration)
Vibration	5-500Hz 1G RMS random vibration
Regulatory	FCC & CE certified
Power	
Input	Auto-sensing 100 to 240VAC, 50 / 60Hz
Consumption	Max. 40 Watt, Standby 5 Watt
Product Dimensions (Single console)	
Product	441.6 x 700 x 44 mm / 17.4 x 27.6 x 1.73 inch
Packing	595 x 910 x 140 mm / 23.4 x 35.8 x 5.5 inch

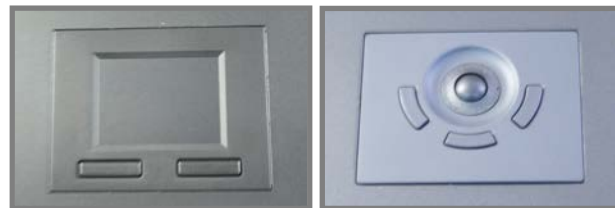

SUN Keyboard / Mouse Options

Se

SUN keyboard integrated with touchpad



Sb

SUN keyboard integrated with trackball



SUN keyboard integrated with touchpad/trackball

- Incorporates SUN keys, including Stop, Cut, Paste, Compose, Copy and Help
- 104 key notepad keyboard with full numerical pad and SUN function
- USB interface
- US layout only

How to Use "SUN" Keyboard



Num LED in Off mode

Key pad behaves as a SUN Solar system administration command mode



Num LED in Green mode

Key pad behaves as a normal key pad mode

Audio / Display Keys

* Please ask your supplier for full details



F9
Audio : Mute
Display : Degauss



F11
Audio : Decrease volume
Display : Decrease contrast



F12
Audio : Increase volume
Display : Increase contrast



- Hold the handle and slide out the drawer.



- Flip up the LCD to a suitable angle



- Operate the LCD console drawer.



Option - Right Side Open

DIMENSION

Front View



Rear View



UNIT : mm
1mm = 0.03937 inch

Side View



Top View



STANDARD KEYBOARD

e keyboard integrated with touchpad



b keyboard integrated with trackball



Supporting layouts

America	 United States				
EMEA	 United Kingdom	 Germany	 France	 Spain	 Norway
	 Italy	 Russia	 Switzerland	 Netherlands	 Portugal
Asia	 China	 Japan	 Korea	 Arabia	 Turkey

STRUCTURE DIAGRAM

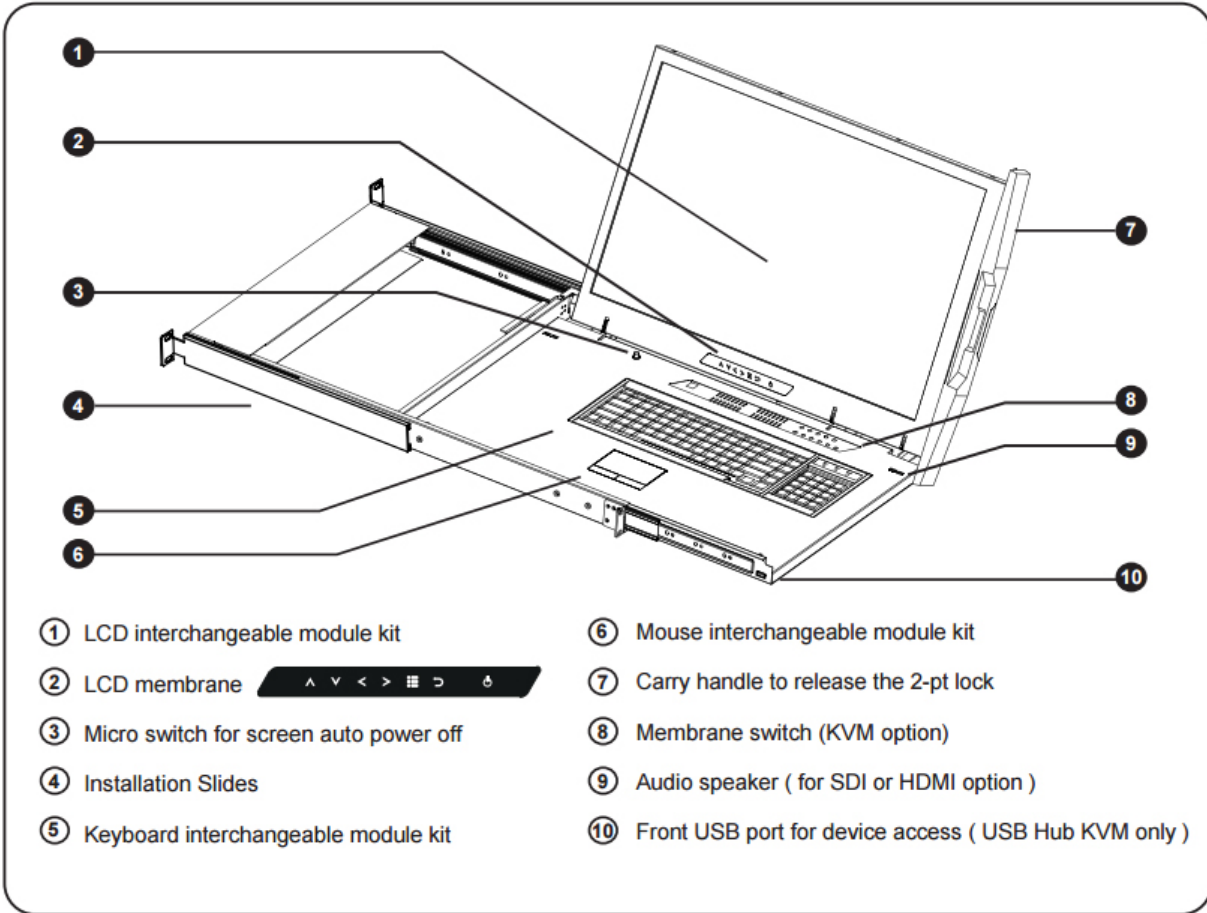

KVM PORT CONNECTION

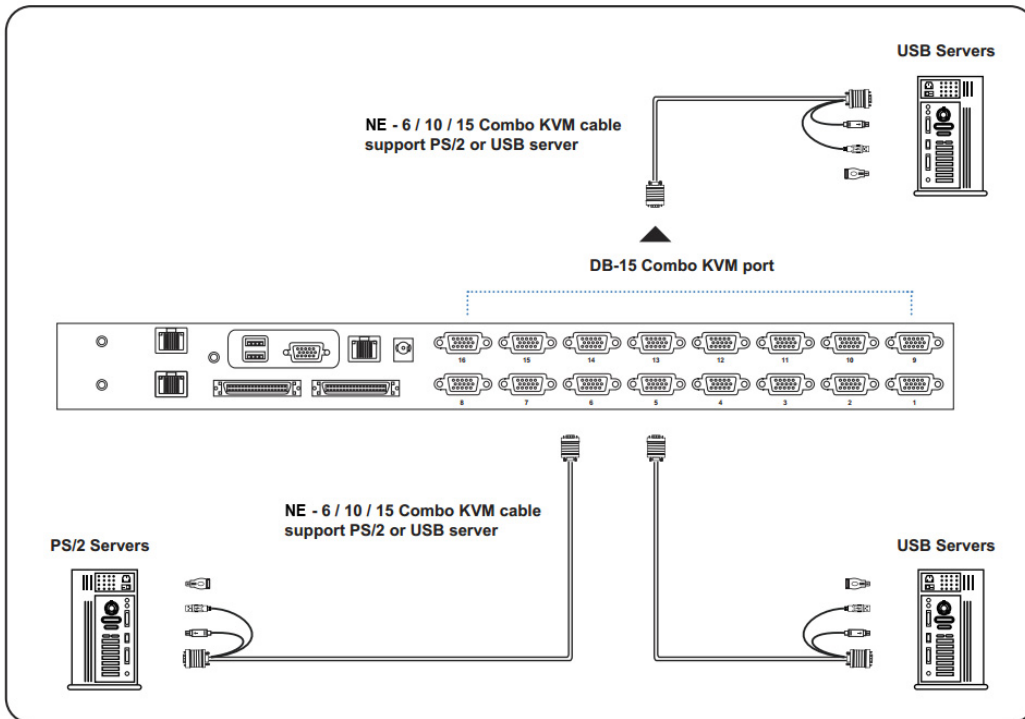

NE-6 / NE-10 / NE-15
 ■ 6 / 10 / 15 ft Combo KVM cable
 ■ Support PS/2 or USB server

Matrix DB-15 KVM Benefits

- Efficient system management with simultaneous multi-user access
- Support resolution up to 1920 x 1080
- SUN 1152 x 900 resolution compatible
- Multi-platform servers shared by different consoles in cascade connection
- Mix PS/2, USB & SUN with Multi-Platform switch capability Extended Cat6 cord remote access up to 150 meters
- Provide a diversity of consoles to access servers independently & simultaneously

Switch Features & Options

- Greater distances between your switch and servers allow enhanced data center rack layouts
- Multi lingual on screen display menu
- Advanced user profiles and configurable OSD hot key combinations

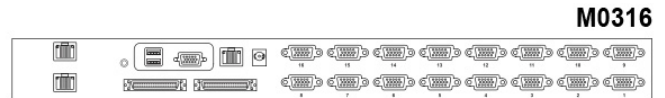
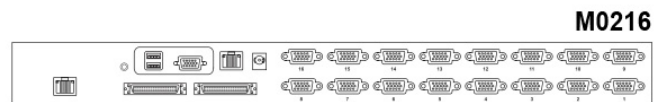
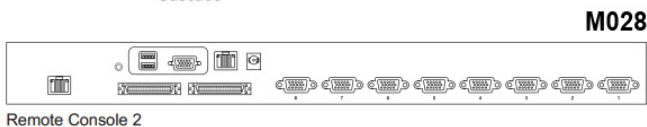
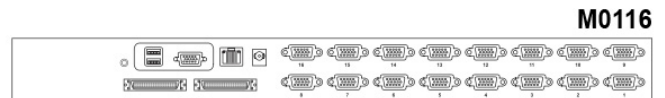

KVM SPECIFICATIONS

■ KVM Port	
Number of ports:	8 or 16
Connector:	DB-15 combo connector
Connectivity:	Combo 4-in-1 KVM cable up to 6, 10 & 15 feet
■ Local Console	
Monitor port:	1 x DB-15 VGA (Up to 1920 x 1080 /1920 x 1200)
Keyboard & mouse port:	2 x USB type connector for keyboard & mouse
■ CAT6 Remote Console	
Number of remote port:	1 for M018 / M0116 2 for M028 / M0216 3 for M038 / M0316
Monitor port:	DB15-pin VGA (Up to 1600 x 1200)
Keyboard & mouse port:	2 x USB type connector for keyboard & mouse
Remote I/O:	RJ45 via Cat5 / Cat5e / Cat6 cable up to 500 feet
■ Expansion	Up to 256 servers by 8-level cascade
■ Compatibility	
Multi-platform:	Mix PCs, SUN and Mac G3 / G4 Mac / iMac
Support:	Windows 7 / Vista / 2003 / XP, Linux, Unix

■ Power	
Input:	AC power adapter
Consumption:	Max. 48 Watt, Standby 5 Watt
■ Regulatory :	
Safety:	cUL, FCC & CE certified
Environment:	RoHS2 & REACH compliant
■ Environmental	
Operating:	0 to 50°C
Storage:	-5 to 60°C
Relative humidity:	90%, non-condensing
Shock:	50G peak acceleration (11ms, half-sine wave)
Vibration:	58-100Hz / 0.98G (11ms / cycle)
■ Product Information	
Dimension (W x D x H):	443 x 171 x 44 mm / 17.4 x 6.7 x 1.73 inch
Net weight:	3 kg / 6.5 lb
■ Packing Information	
Dimension (W x D x H):	500 x 400 x 90 mm / 19.7 x 15.7 x 3.5 inch
Gross weight:	5 kg / 11 lb

REMOTE & LOCAL CONSOLE CONNECTION



KVM CASCADE

- Cascade up to 8 levels, 240 servers
- Cascading multiple KVM with CMC-8 cascade cable

Master KVM



out — in
Cascade

To cascade IN port



Cascaded KVMs from level 2 to 8 must be the models of M018 / M0116 or MC0116 / MC0132.



When multiple matrix KVMs cascade together, the master KVM at level 1 will take all control of other slave KVM switches (e.g. level 2 to 8).



The slave matrix KVM will be as a port expansion module of the master matrix KVM, the original remote console on slave KVM will be sacrificed and disabled.



CMC-8

- 8ft Matrix KVM cascade cable