

# RUGGED MILITARY PANEL PC

24" Rugged Military Panel PC, 1920 x 1200 Ultra HD, Intel 8th Generation i7-8700T 2.4~4.0GHz CPU, 64G RAM, 500G SSD, 4 x USB3.1, 3 x LAN, VGA, DVI, HDMI, DP, 2 x COM, 3 x Audio

MIL-STD-461 EMI/EMC design  
MIL-STD-810 vibration / shock design



**Model: NmilW2400i7-PCT10**

## SPECIFICATIONS:

LCD Module	
LCD Size	24" Diagonal Active matrix TFT LCD
Resolution	1920 x 1200
Contrast Ratio	1000 : 1
Brightness	300 cd/m2
Touch	
Touch Type	Projective Capacity Touch
Touch Point	10 Points (10 Fingers)
Mainboard & Processor	
Mainboard	Military grade
CPU	Intel® 8 <sup>th</sup> Gen i7-8700T 6 Core 2.4~4.0GHz, 12MB cache, 35/25W power
System Memory	
RAM	64GB SD-RAM DDR4 2666/2400 MHz
Storage Disk	
SSD/HDD	M.2 #2282 500GB SSD
I/O Port (Number of I/O ports can be custom designed per your request)	
LAN	3 x 10/100/1000 Base-T Ethernet
USB	4 x USB3.1 ultra high speed port
COM	2 x Serial Ports (1 x RS232/422/485, 1 x RS232)
VGA	1 x VGA
DVI	1 x DVI
HDMI	1 x HDMI
DP	1 x DP ports
Audio	3 x Audio (Speaker-out, Mic-in, Line-in)
Power	1 x DC, with military circular connector
Power Supply	
DC Input	DC28V (DC16~32V)
Power Consumption	Around 50~62W
Mechanical	
Front Bezel	Aluminum alloy rugged front bezel
Enclosure	Rugged galvanized steel with anti-corrosion treatment
Design	Fanned Design
Mounting	Support Front Mount
Environmental	
Operating Temperature	0 to +50°C
Storage Temperature	-20 to +65°C

**MECHANICAL DRAWINGS:**

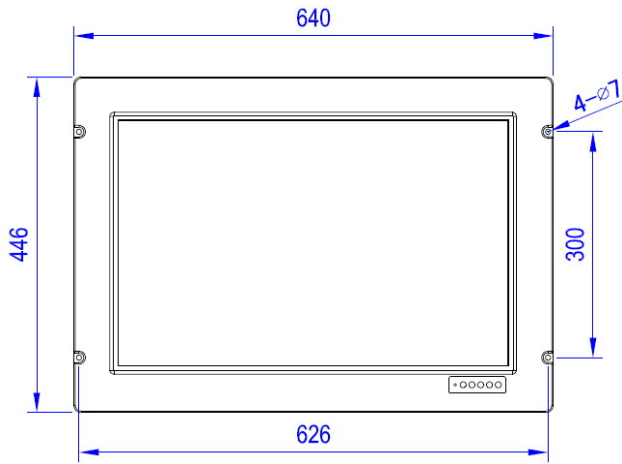

**Front View**

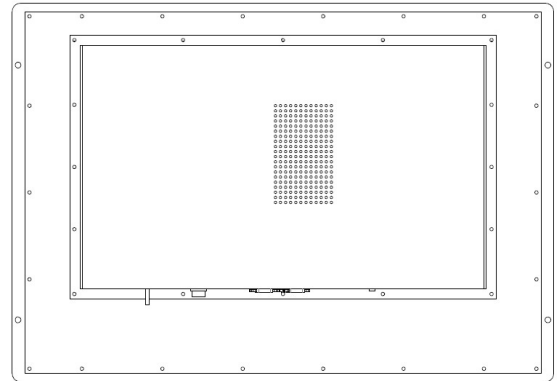

**Rear View**

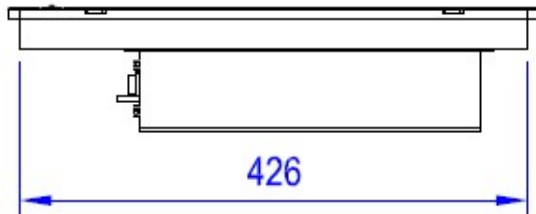

**Side View 1**

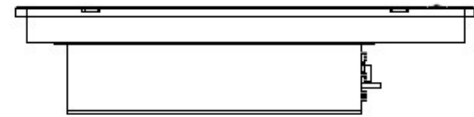

**Side View 2**

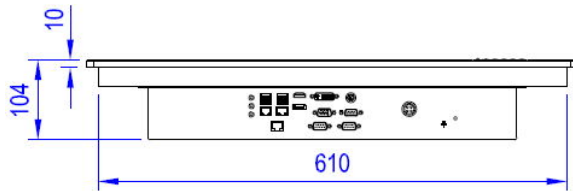

**Bottom View**

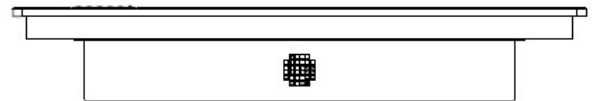

**Top View**

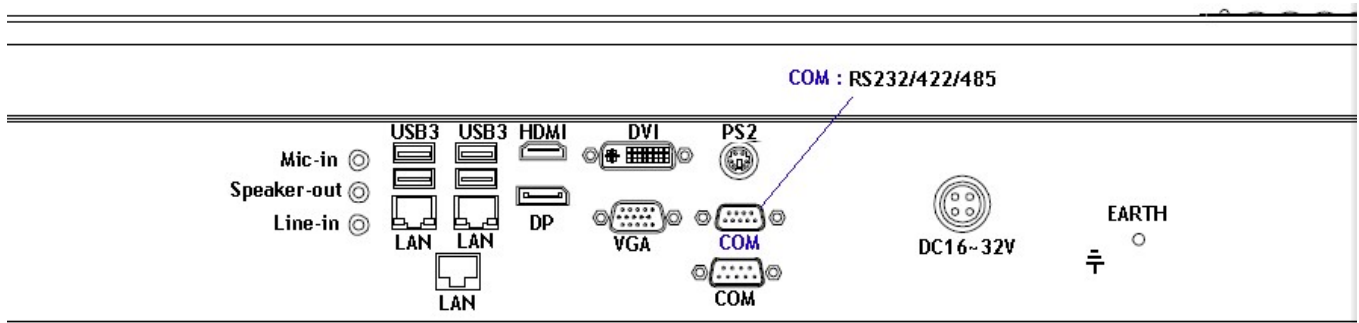

**I/O Ports**